

3SVX21R030PT04QBE

Technical data

Company name
Contact
Phone number
e-mail address

Operating data					
1	Pumpe type	vertical		Fluid	Water, pure
2	No. of pumps		1	Operating temperature at t A	°C 4
3	Nominal flow	m³/h	0	pH-value at t A	7
4	Nominal head	m	0	Density at t A	kg/m³ 1000
5	Static head	m	0	Vapor pressure at t A	kPa 100
6	Inlet pressure	kPa	0	Kin. viscosity at t A	mm²/s 1.569
7	Environmental temperature	°C	20	Altitude	0
8	Available system NPSH	m	0		

Pump data		
9	Product version	[X] - Hydrovar X+
10	Operating speed	
11	Stages	21
12	Max. working pressure	kPa 2310.9
13	Head H(Q=0)	m 240
14	Power input P1(max)	kW 3.5
15	Total weight	kg 41.5
16	Power input	kW
17	Overall efficiency	%
18	Shaft power	kW
19	Pump efficiency	%
20	NPSH 3%	m
21		

Materials			
	Pump	Shaft Seal	
22			
23	Pump body	Stainless steel / AISI 304	Mechanical seal
24	Impeller	Stainless steel / AISI 304	Uniten (-30 / +120 °C)
25	Diffuser	Stainless steel / AISI 304	
26	Outer sleeve	Stainless steel / AISI 304	1 - Rotating part Silicon Carbide
27	Shaft	Stainless steel / AISI 304	2 - Stationary part Resin impregnated carbon
28	Adapter	Cast iron	3 - Elastomers EPDM
29	Base	Aluminium	4 - Springs AISI 316
30	Coupling	Aluminium	5 - Other components AISI 316
31	SEAL HOUSING	Stainless steel / AISI 304	
32	Coupling protection	Stainless steel / AISI 304	
33	Shaft sleeve and bushing	Tungsten carbide	
34	Fill / drain plugs	Stainless steel / AISI 304	
35	Tie rods	Galvanized steel	
36	Wear ring	Technopolymer PPS	
37			
38			
39			
40			
41			

Motor data				
42	Manufacturer	Xylem	Rated voltage	380-480V
43	Specific design	IE5 Three phase motor	Rated current	6,7-5,3 A
44	Type	EXM100B5/4.030BH2	Motor efficiency @400V %	4/4: 87.8 3/4: 87.6 2/4: 85.8
45	Rated power	3 kW	Power factor @400V	0.86
46	Nominal speed	3600 rpm	Weight	kg 24.7
47	Frame size	100		
48	Size	B		

Remarks	
49	
50	
50	
52	

3SVX21R030PT04QBE

Performance curve

Company name
Contact
Phone number
e-mail address

Ø	Pump capacity			Pump head		Frequency	Hz	50/60
	Operating range	η	η	H(Q=0)	η			
	Min. m³/h	Max. m³/h	Max. m³/h	m	m	Operating speed	rpm	
Max.	1.21	5.22	3.63	236	185	Nominal flow	m³/h	0
						Nominal head	m	0
						Inlet pressure	kPa	0
						Static head	m	0

Power datas referred to:

hydr. Performance acceptance acc. To EN ISO 9906 Class 3B

Water, pure [100%] ; 4°C; 1000kg/m³; 1.57mm²/s

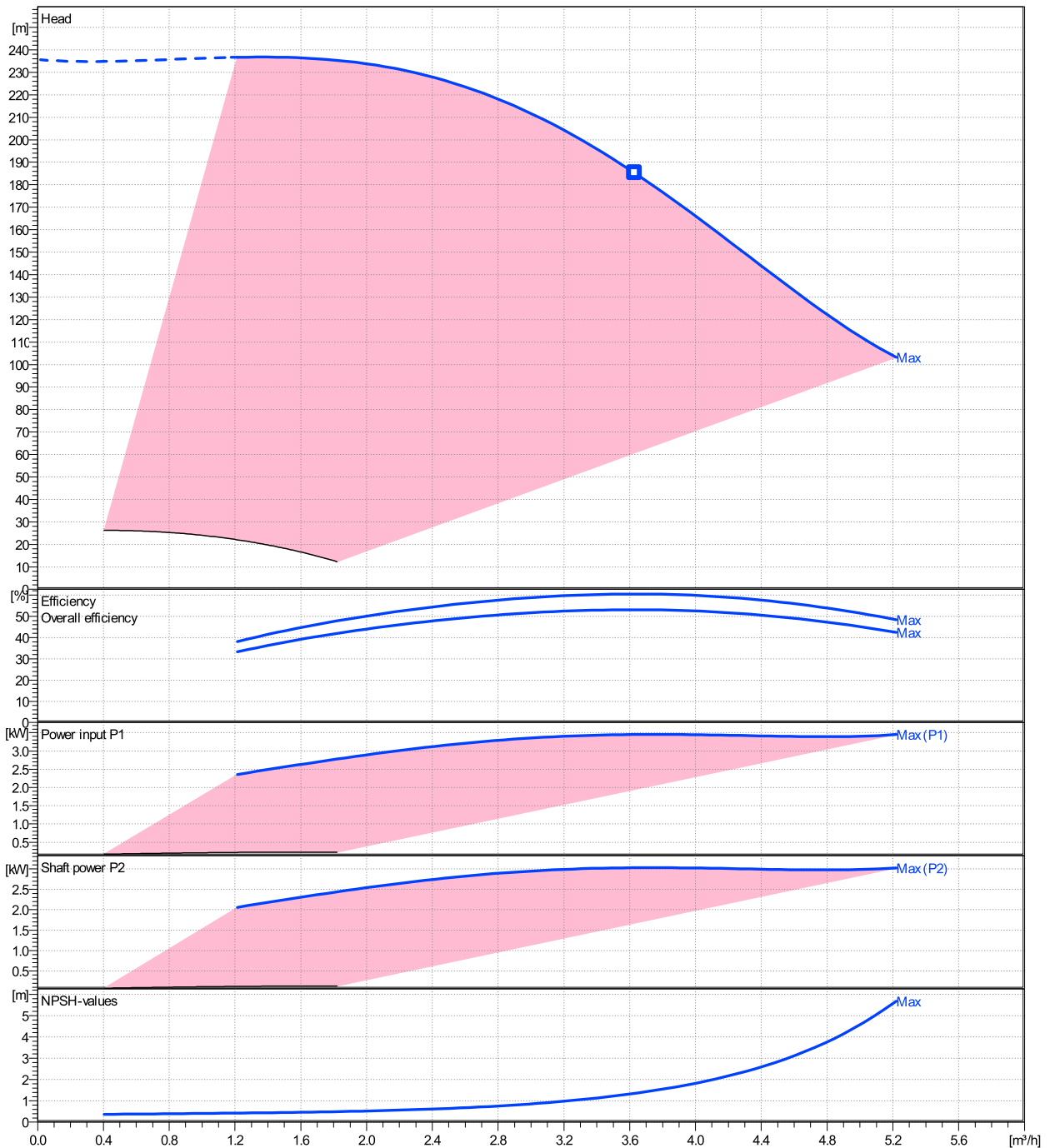

3SVX21R030PT04QBE

Dimensions

Company name
Contact
Phone number
e-mail address

[X] - Hydrovar X+
EXM100B5/4.030BH2

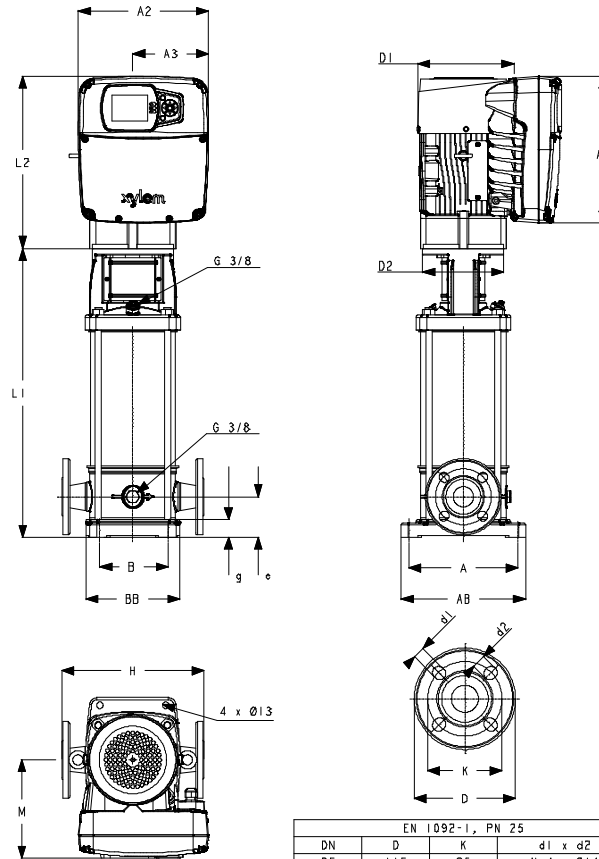

EN 1092-1, PN 25			
DN	D	K	d1 x d2
25	115	85	N. 4 x Ø14
32	140	100	N. 4 x 18 x 18.8
40	150	110	N. 4 x 18 x 20.5
50	165	125	N. 4 x 18 x 20.5

Dimensions [mm]	
A	180
A1	289
A2	256
A3	149
AB	210
B	100
BB	150
D1	179
D2	160
DN	25
e	75
g	25
H	250
L1	668
L2	339
M	194
Weight	
Total weight	41.5 kg

Dimensions and weight without obligation

Project	Xylect-22232589	Created by		Last update	5/2/2024
Block	3SVX21F030PT04QBE	Created on	5/2/2024		

3SVX21R030PT04QBE

Technical data

Company name
Contact
Phone number
e-mail address



REF.	ITEM	DESCRIPTION	DEFAULT
1		Power supply +24 VDC, max. 60mA (total, terminals 1 + 5)	
2	Analog Input 1	Configurable Analog Input 1	Pressure Sensor 1
3		Electronic GND	
4	Not used	Internal use - Do not connect	
5		Power supply +24 VDC, max. 60mA (total, terminals 1 + 5)	
6	Analog Input 2	Configurable Analog Input 2	Not used
7		Electronic GND	
8	External Start/Stop	Start/Stop digital input, +24 VDC internal pull-up, 6mA contact current	-
9		Electronic GND	
10	External Lack of Water	Low water digital input, +24 VDC internal pull-up, 6mA contact current	-
11		Electronic GND	
12	Digital Input 3	Configurable Digital Input 3, +24 VDC internal pull-up, 6mA contact current	Solo Run
13		Electronic GND	
14	Analog Output	Configurable Analog Output	Motor Speed
15		Electronic GND	
16		Power supply +24 VDC, max. 60mA (total, terminals 16 and 19)	
17	Analog Input 3	Configurable Analog Input 3	Not used
18		Electronic GND	
19		Power supply +24 VDC, max. 60mA (total, terminals 16 and 19)	
20	Analog Input 4	Configurable Analog Input 4	Not used
21		Electronic GND	
22	Digital Input 4	Configurable Digital Input 4, +24 VDC internal pull-up, 6mA contact current	Not used
23		Electronic GND	
24	Digital Input 5	Configurable Digital Input 5, +24 VDC internal pull-up, 6mA contact current	Not used
25		Electronic GND	
26	10 VDC supply	Power supply +10 VDC, max. 3mA	-
27		Electronic GND	
28		RS485 port 1 : RS485-1B N (-)	
29	Communication bus 1	RS485 port 1 : RS485-1A P (+)	Multipump
30		RS485 port 1 : RS485-COM	
31		RS485 port 2 : RS485-2B N (-)	
32	Communication bus 2	RS485 port 2 : RS485-2A P (+)	Modbus
33		RS485 port 2 : RS485-COM	
34		RS485 port 1 : RS485-1B N (-)	
35	Communication bus 1	RS485 port 1 : RS485-1A P (+)	Multipump
36		RS485 port 1 : RS485-COM	
37		RS485 port 2 : RS485-2B N (-)	
38	Communication bus 2	RS485 port 2 : RS485-2A P (+)	Modbus
39		RS485 port 2 : RS485-COM	
40		Configurable relay 1: Normally Open	
41	Relay 1	Configurable relay 1: Normally Closed	Running
42		Configurable relay 1: Common Contact	
43		Configurable relay 2: Normally Open	
44	Relay 2	Configurable relay 2: Normally Closed	Error
45		Configurable relay 2: Common Contact	