



MAGNA1

One of a kind

A full range of high-efficiency circulators for heating, cooling, ground source heat pump systems and domestic hot water applications.

be
think
innovate

GRUNDFOS 



One of a kind

The MAGNA1 range of circulators comes complete with electronically controlled motors that are based on permanent magnet (PM) and stator technology. They are designed for circulating liquids in a wide range of light commercial and commercial applications including:

- Heating systems
- Air conditioning and cooling systems
- Domestic water systems
- Ground-source heat pump systems
- Solar heating systems.

With the addition of the MAGNA1 range Grundfos can now deliver the required high energy efficiency, but with a reduced set of features. These pumps can offer the perfect solution in a refurbishment situation where you need to either replace a Grundfos UPS product or one of the smaller models from the original Magna family. These pumps are designed for circulating liquids in heating systems with variable flows where it is desirable to optimise the settings of the pump duty point, thus reducing energy costs.

To ensure correct operation, it is important that the sizing range of the system falls within the duty range of the pump. The MAGNA1 range features 44 single and 39 twin pump models in DN25 to DN100 flange sizes as well as improved hydraulics and a compact stator designed to minimise electrical energy consumption. The new product sets the pace in the circulator pump industry already meeting the Energy Efficiency Index (EEI) level set for 2015.

The MAGNA1 is a member of the Grundfos MAGNA family, see MAGNA3 brochure or visit www.grundfos.co.uk for further information.

Full range – perfect fit

With a wide range of different single and twin head options covering even more duties, specifying for HVAC applications has never been easier. The extended range offers a maximum head of 18m and maximum flow of 70m³/h (140 m³/h for twin head models), and a 6 to 10 bar system pressure.

These pumps are designed to handle liquids down to -10°C which makes them suitable for both tough industrial tasks and ground source heat systems. As the liquid temperature (-10°C to +110°C) is now independent of the ambient temperature (0°C to +40°C) ensuring the MAGNA1 will be a perfect fit regardless of whether your project requires heating or cooling circulation.

Features:

- Proportional pressure control
- Constant pressure control
- Constant curve/constant speed duty
- No external motor protection required
- Insulating shells are supplied with single head pumps for heating systems
- Wide temperature range where the liquid temperature and the ambient temperature are independent of each other.

Benefits:

- Simple installation
- Low energy consumption – all MAGNA1 pumps comply with EuP/ErP 2013 and 2015 requirements
- Nine possible pump settings
- Low noise level
- Minimal maintenance and long life
- Range is available for a maximum system pressure of 6 and 10 bar.

Type Key

Code	Example	MAGNA1	(D)	80	-120	(F)	(N)	280
	Type range MAGNA1							
D	Single-head pump Twin-head pump							
	Nominal diameter (DN) of suction and discharge ports [mm]							
	Maximum head [dm]							
F	Pipe connection Flange							
N	Pump housing material Cast iron Stainless steel							
	Port-to-port length [mm]							

Performance range MAGNA1

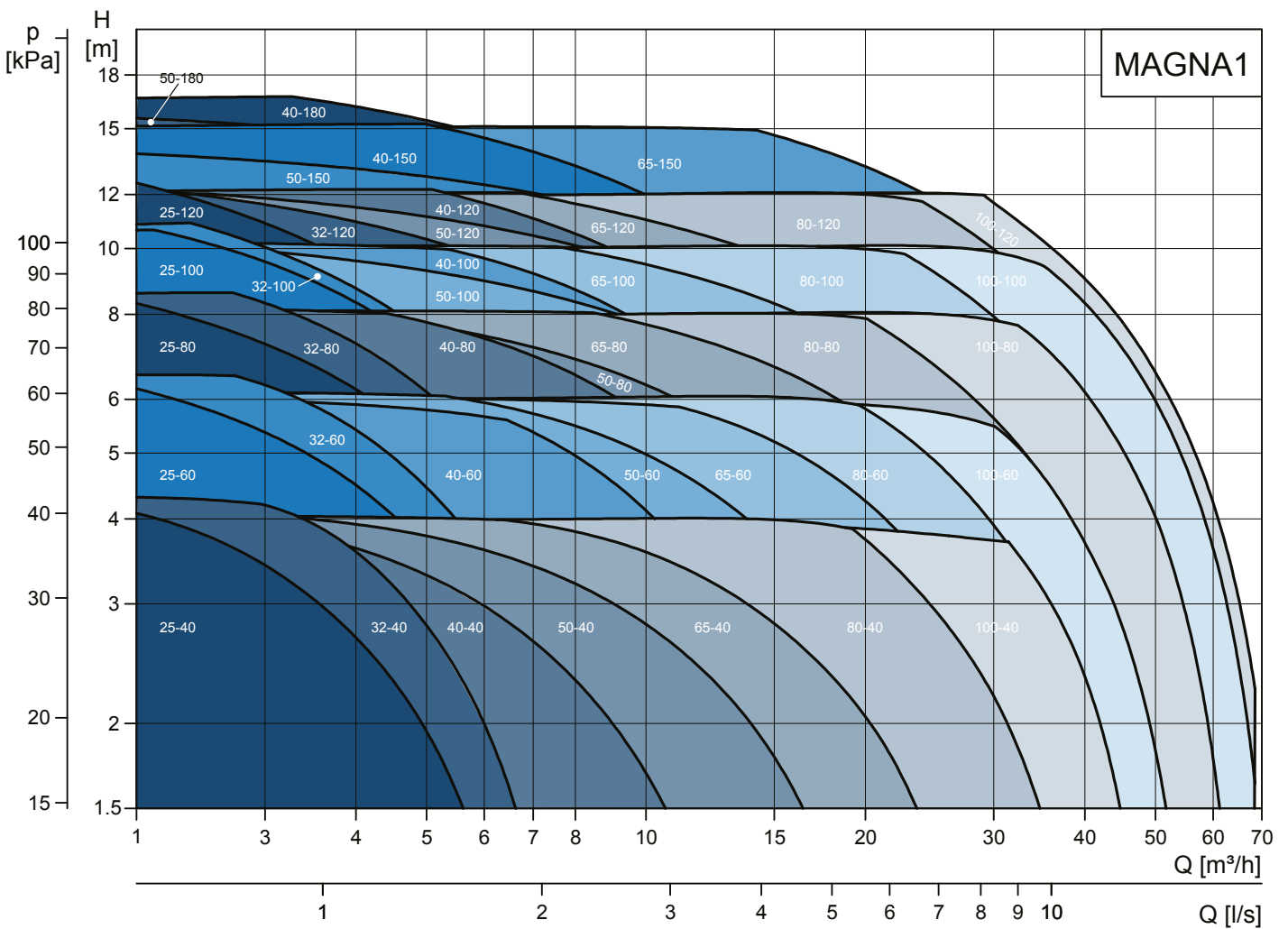

Overview of settings

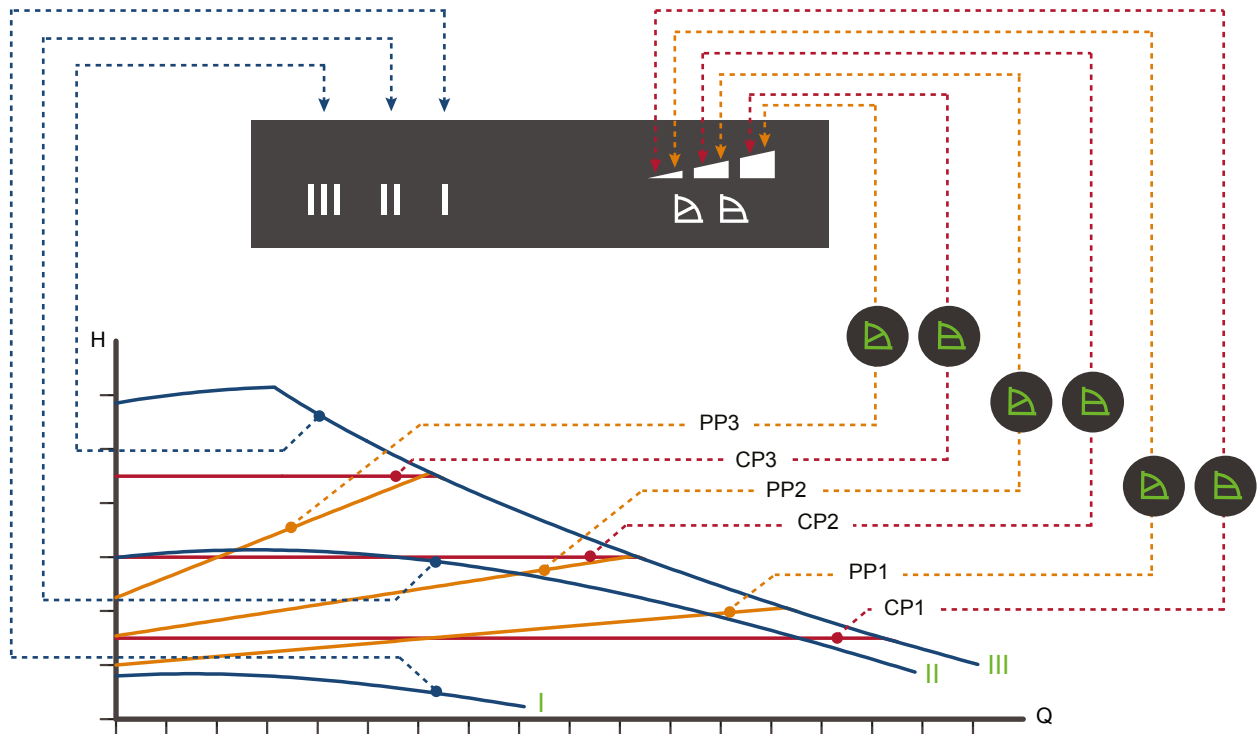
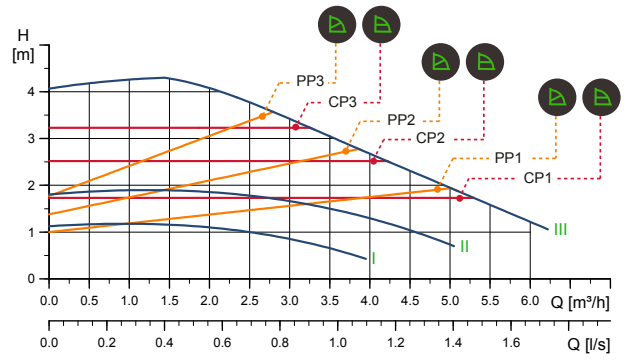

Fig. 1 Pump setting in relation to pump performance

Setting	Pump curve	Function
PP1	Lowest curve	Proportional Pressure The pump duty point will move up and down the proportional pressure curve as the system heating demand changes with time. When the heating demand is rising the pump flow and head will increase as the heating system valves open. When the heating demand is falling the pump flow and pressure will decrease as the heating system valves close.
PP2	Intermediate curve	
PP3	Highest curve	
CP1	Lowest curve	Constant Pressure The pump duty point will move along the constant pressure curve as the system heating demand changes with time. When the heating demand is rising the pump flow will increase as the heating system valves open. When the heating demand is falling the pump flow will decrease as the heating system valves close.
CP2	Intermediate curve	
CP3	Highest curve	
III	Speed III	In speed III, the pump is set to run on the max. curve under all operating conditions. Quick venting of the pump can be obtained by setting the pump to speed III for a short period.
II	Speed II	In speed II, the pump is set to run on the intermediate curve under all operating conditions.
I	Speed I	In speed I, the pump is set to run on the min. curve under all operating conditions.

MAGNA1 25-40 (N)



MAGNA1 25-60 (N)

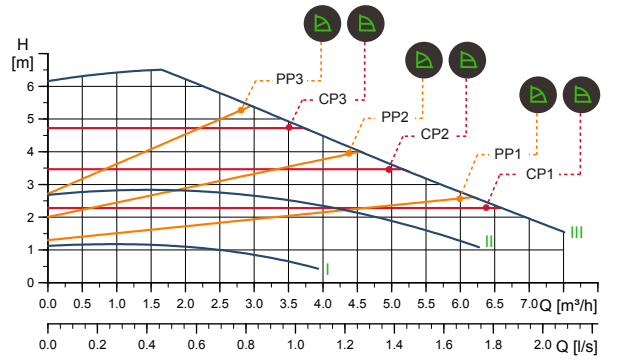

MAGNA1 25-80 (N)

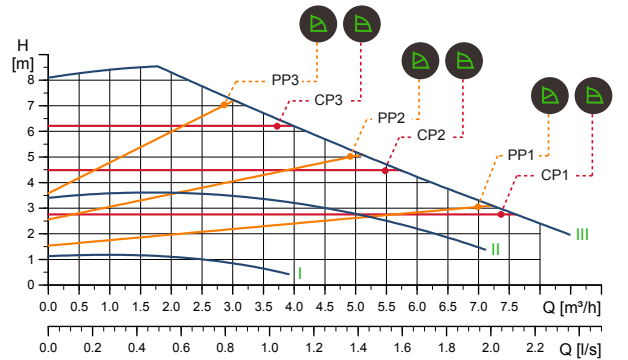

MAGNA1 25-100 (N)

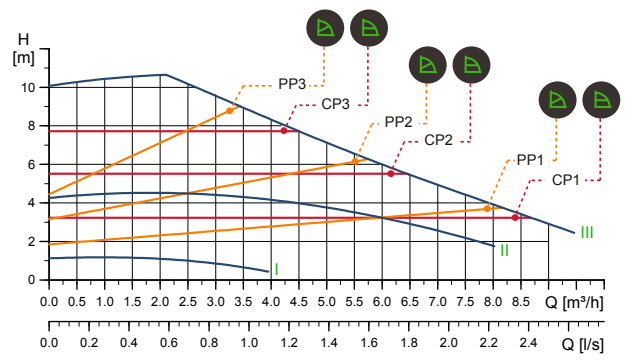

MAGNA1 25-120 (N)

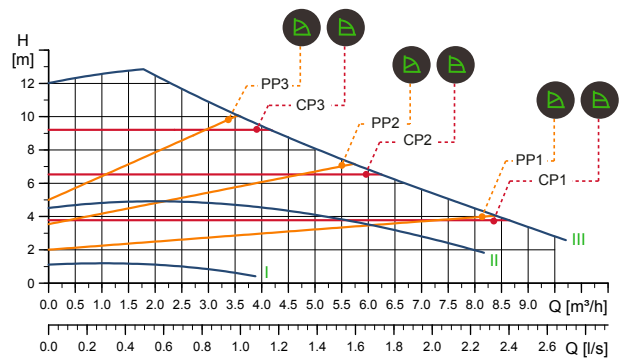

MAGNA1 32-40 (N)

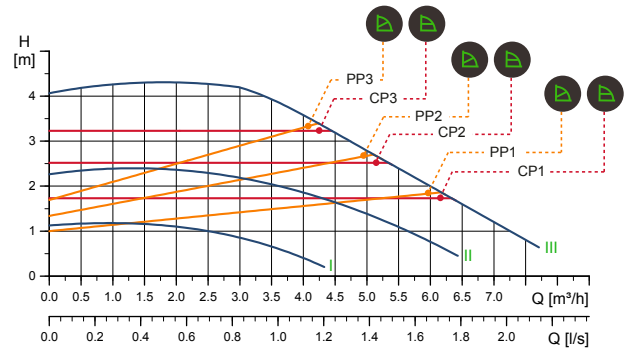

MAGNA1 32-60 (N)

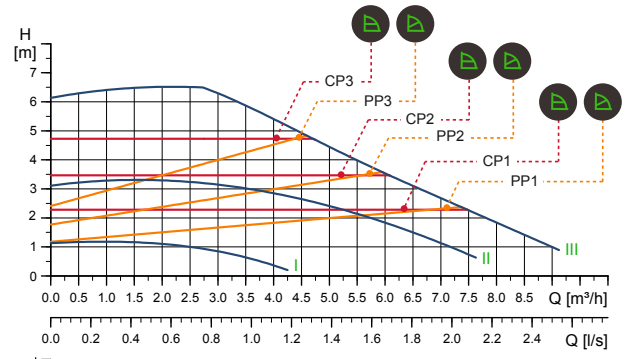

MAGNA1 32-80 (N)

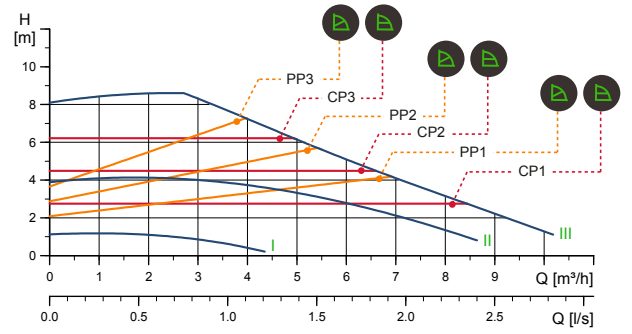

MAGNA1 32-100 (N)

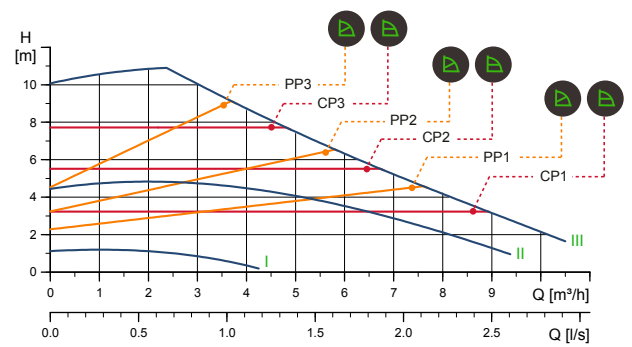

MAGNA1 32-40 F (N)

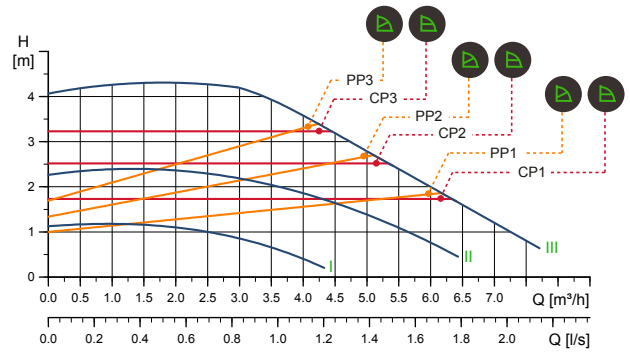

MAGNA1 32-60 F (N)

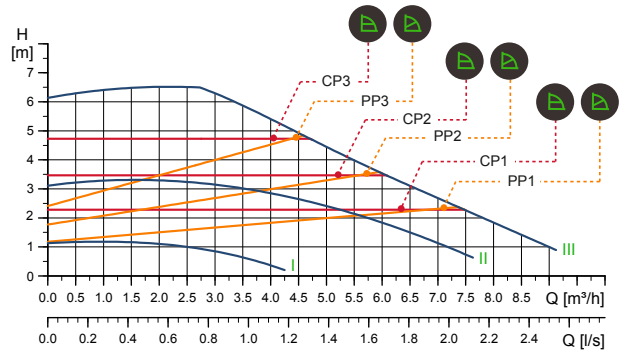

MAGNA1 32-80 F (N)

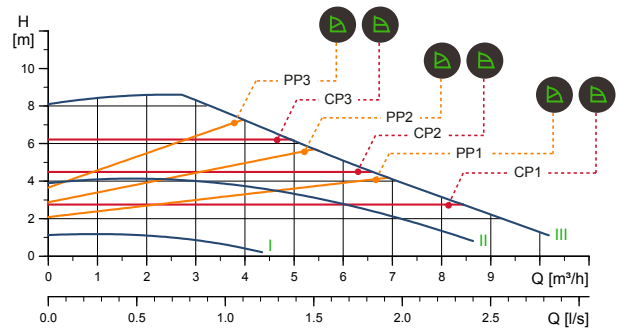

MAGNA1 32-100 F (N)

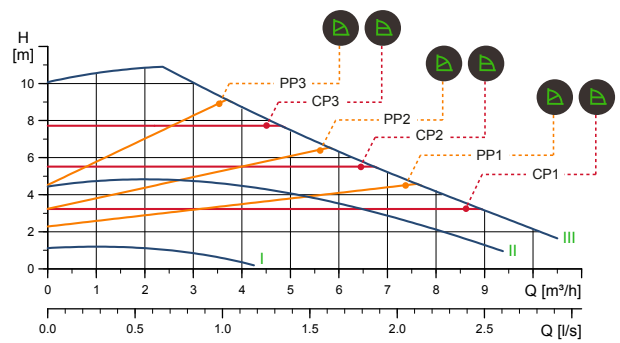

MAGNA1 32-120 F (N)

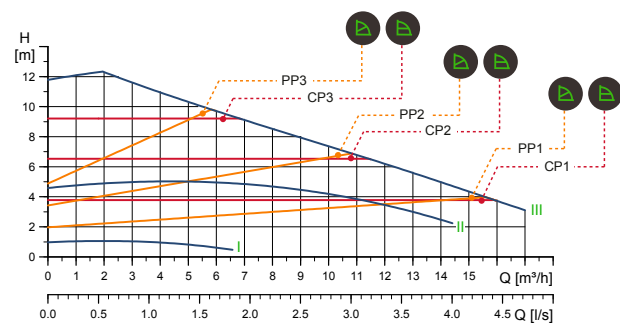

MAGNA1 40-40 F (N)

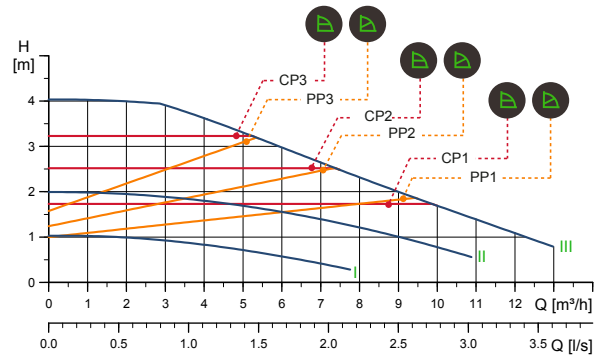

MAGNA1 40-60 F (N)

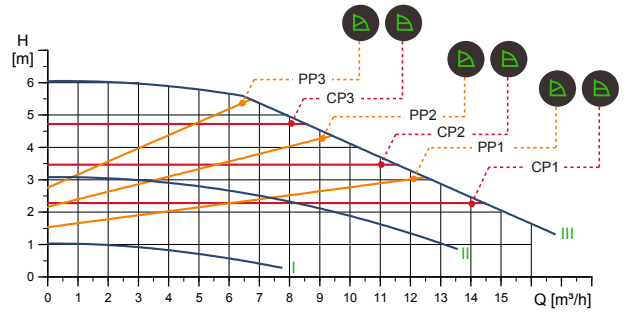

MAGNA1 40-80 F (N)

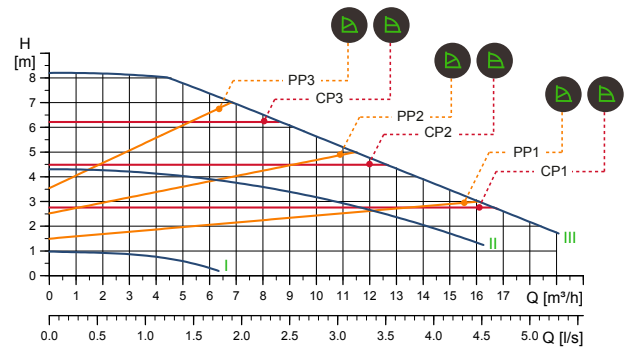

MAGNA1 40-100 F (N)

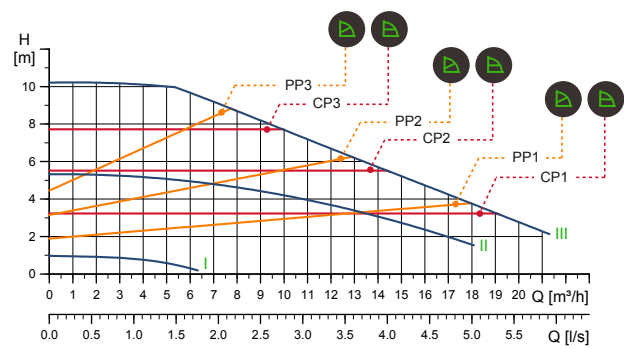

MAGNA1 40-120 F (N)

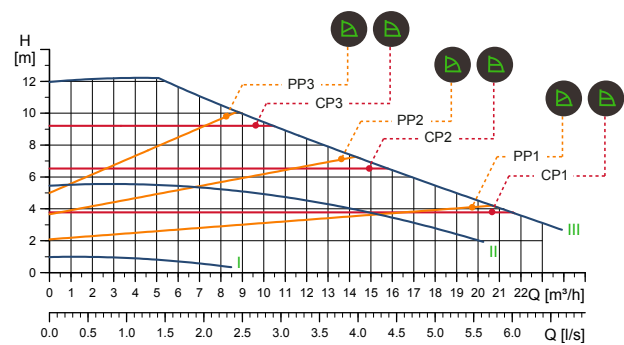

MAGNA1 40-150 F (N)

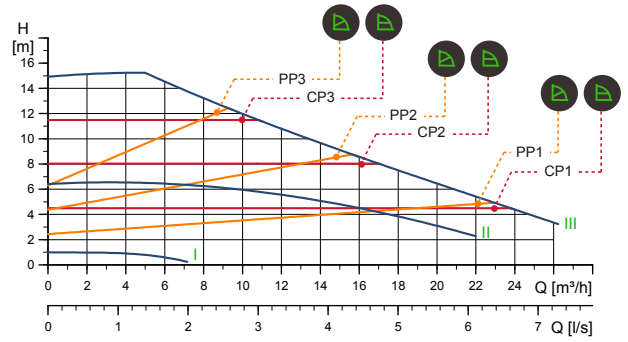

MAGNA1 40-180 F (N)

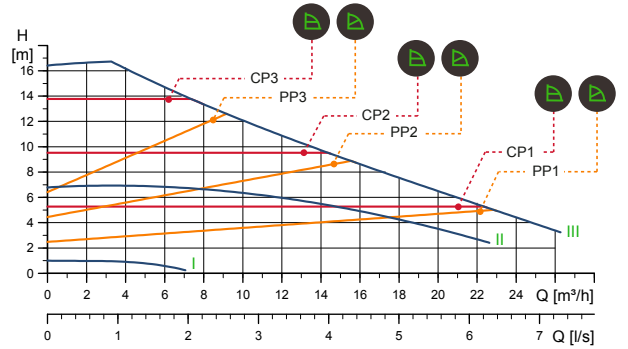

MAGNA1 50-40 F (N)

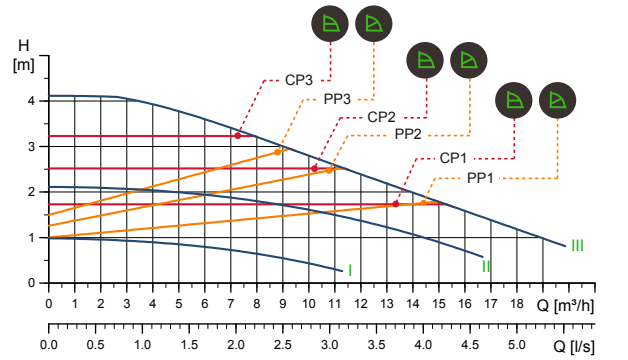

MAGNA1 50-60 F (N)

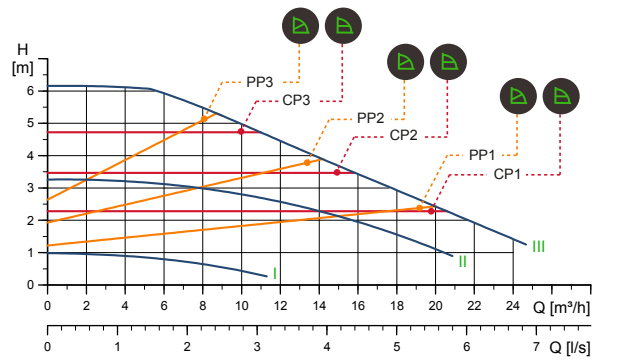

MAGNA1 50-80 F (N)

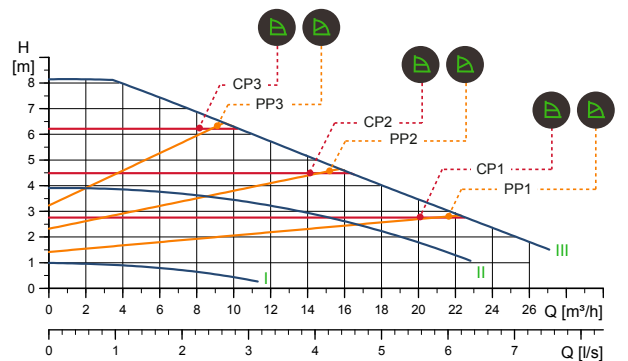

MAGNA1 50-100 F (N)

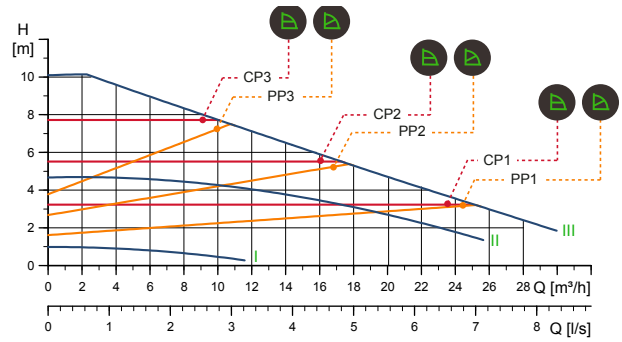

MAGNA1 50-120 F (N)

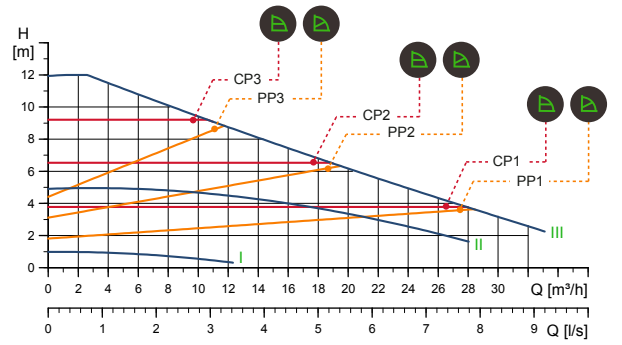

MAGNA1 50-150 F (N)

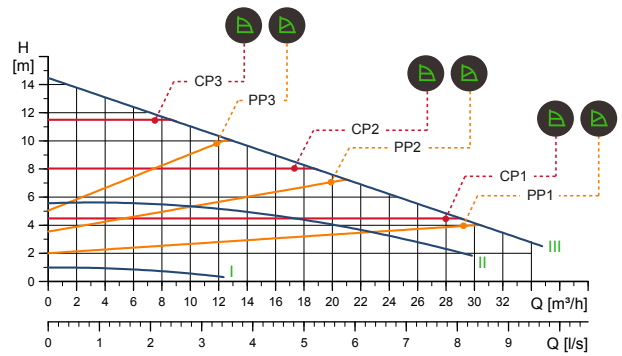

MAGNA1 50-180 F (N)

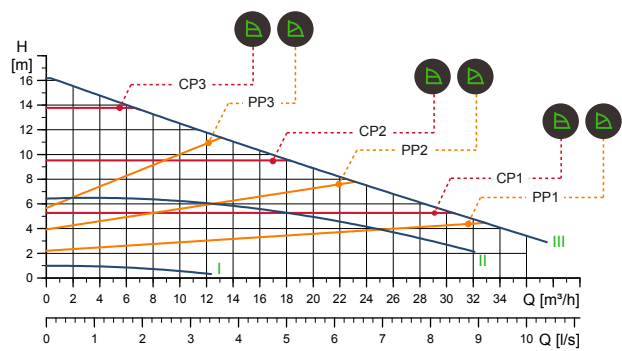

MAGNA1 65-40 F (N)

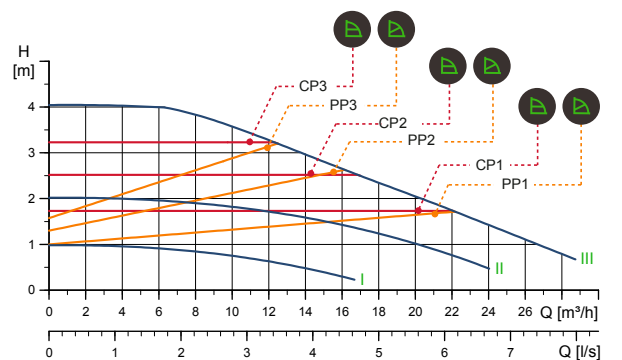

MAGNA1 65-60 F (N)

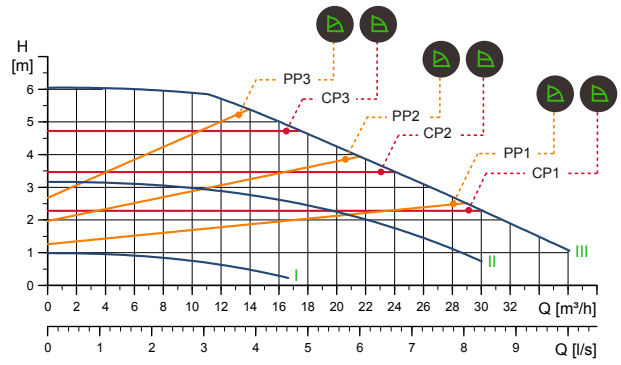

MAGNA1 65-80 F (N)

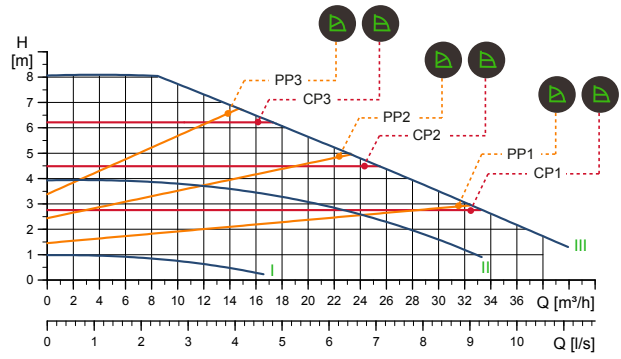

MAGNA1 65-100 F (N)

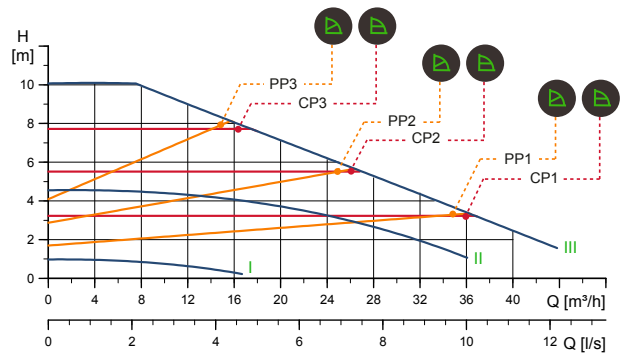

MAGNA1 65-120 F (N)

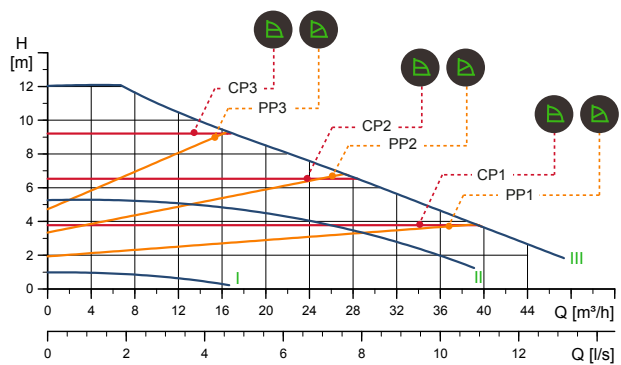

MAGNA1 65-150 F (N)

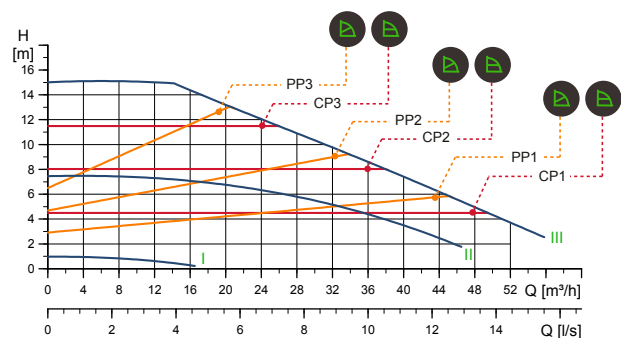

MAGNA1 80-40 F

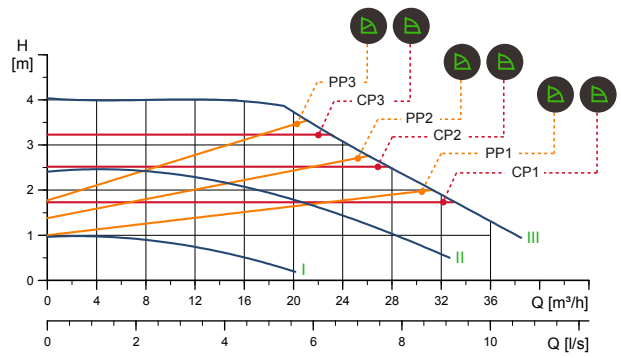

MAGNA1 80-60 F

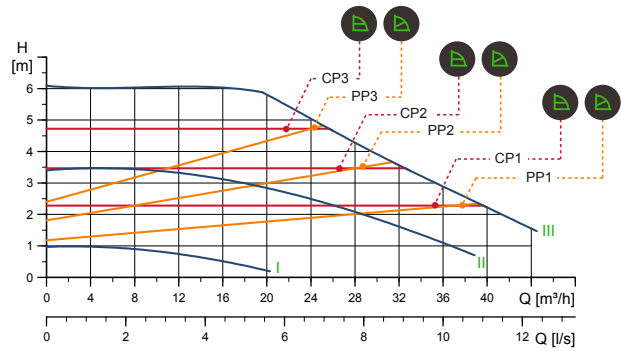

MAGNA1 80-80 F

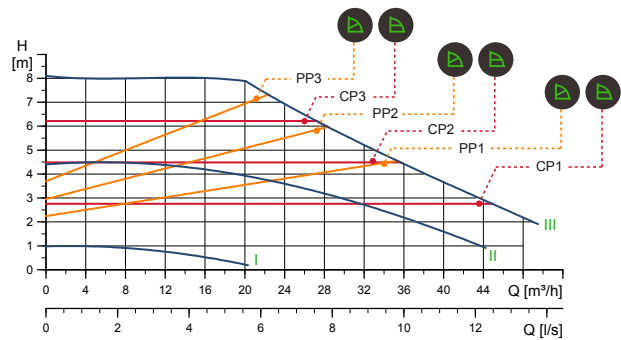

MAGNA1 80-100 F

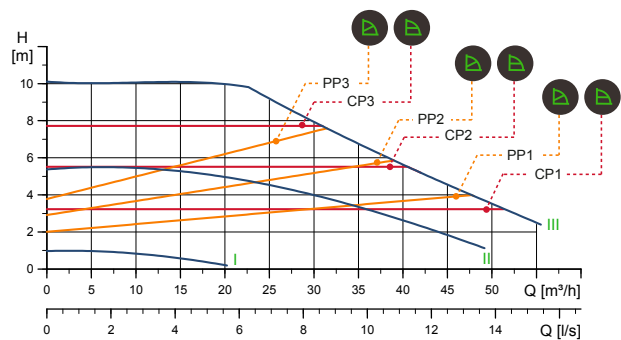

MAGNA1 80-120 F

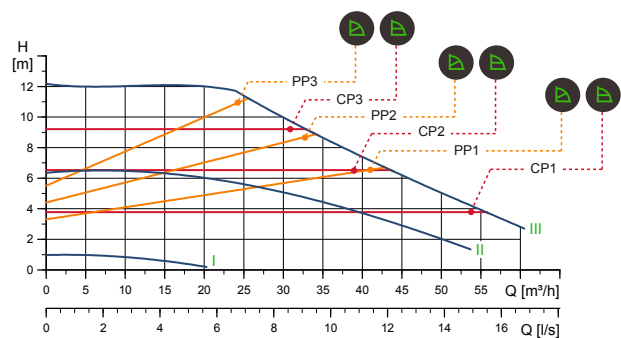

MAGNA1 100-40 F

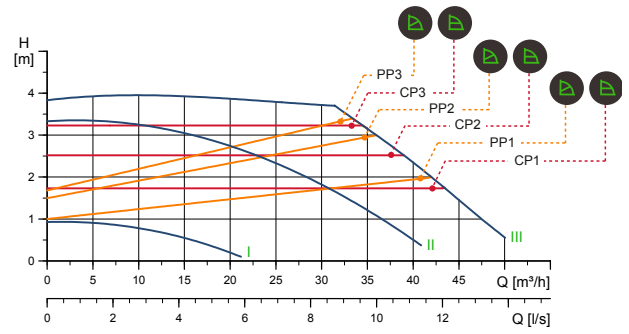

MAGNA1 100-60 F

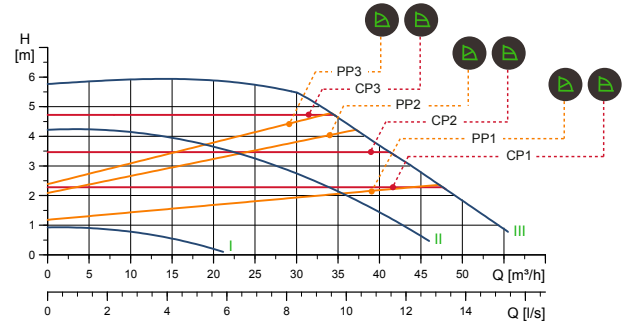

MAGNA1 100-80 F

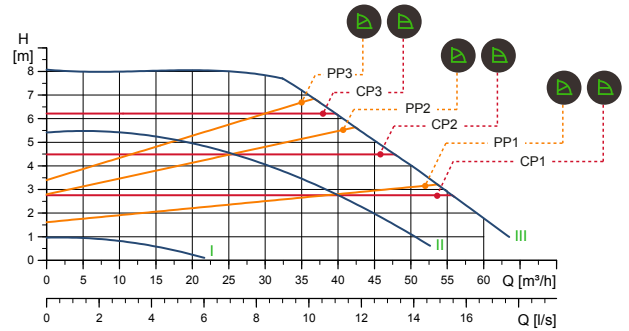

MAGNA1 100-100F

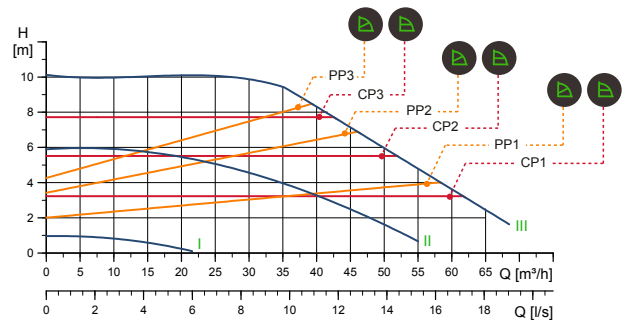

MAGNA1 100-120 F

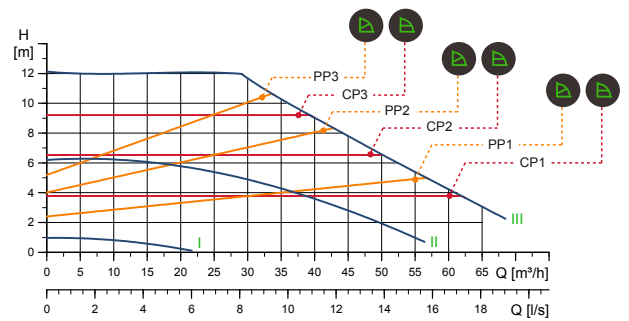

MAGNA1 D 32-40

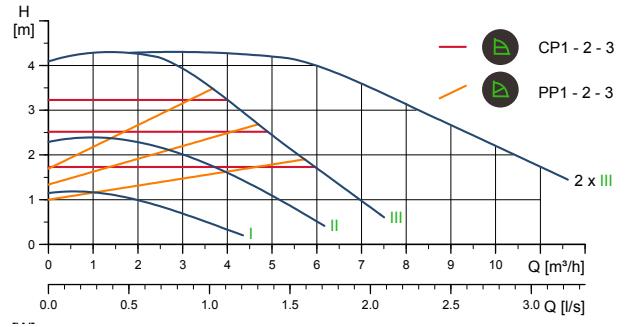

MAGNA1 D 32-60

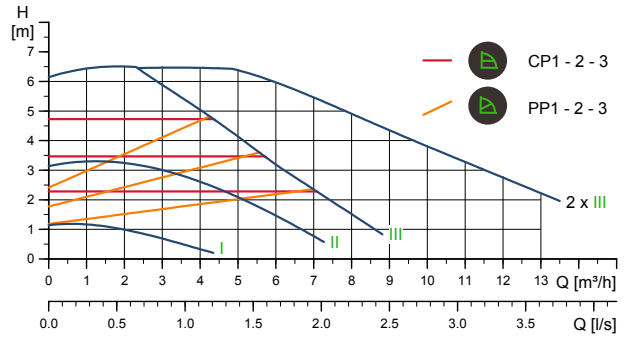

MAGNA1 D 32-80

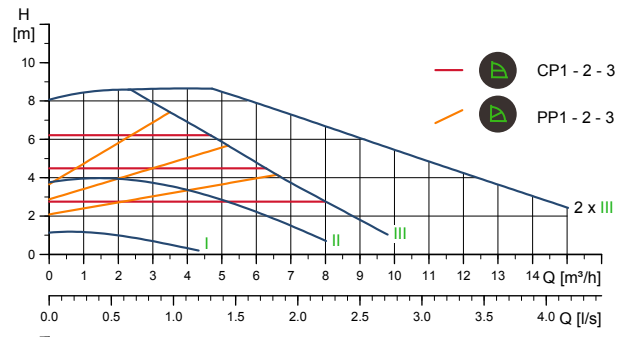

MAGNA1 D 32-100

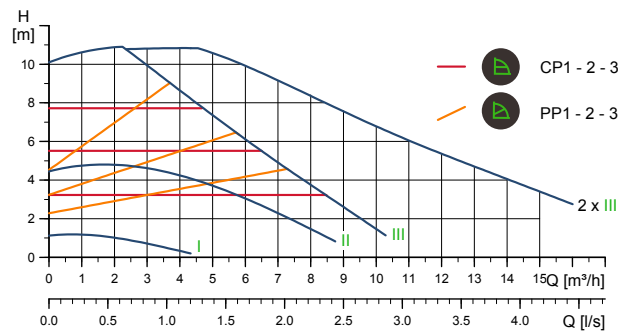

MAGNA1 D 32-40 F

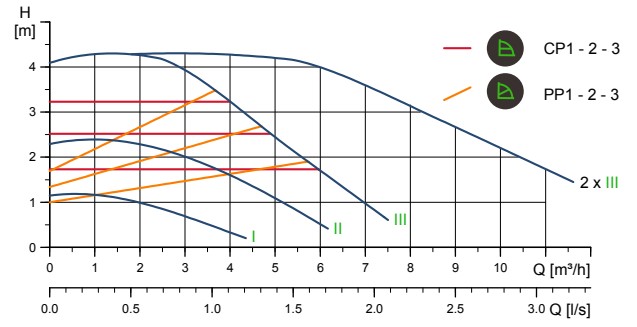

MAGNA1 D 32-60 F

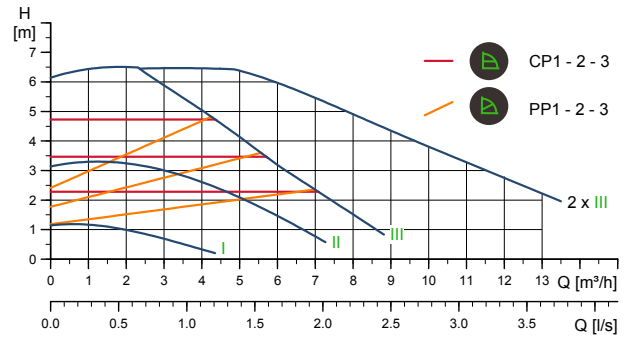

MAGNA1 D 32-80 F

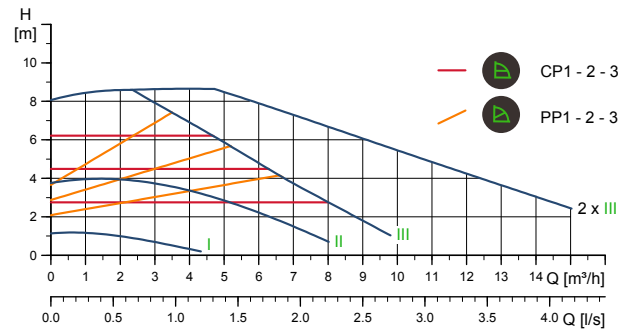

MAGNA1 D 32-100 F

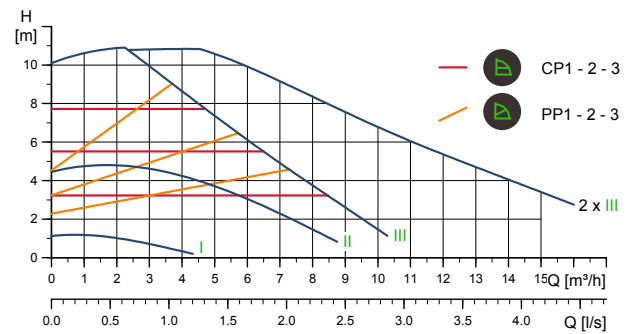

MAGNA1 D 32-120 F

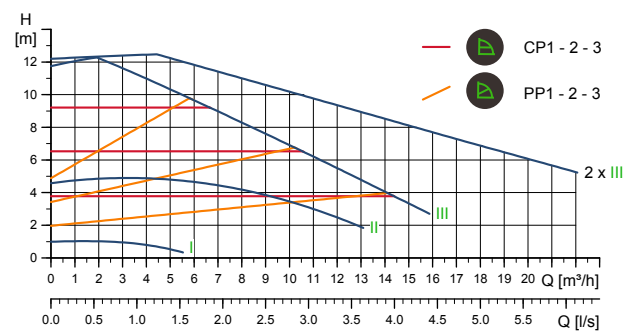

MAGNA1 D 40-40 F

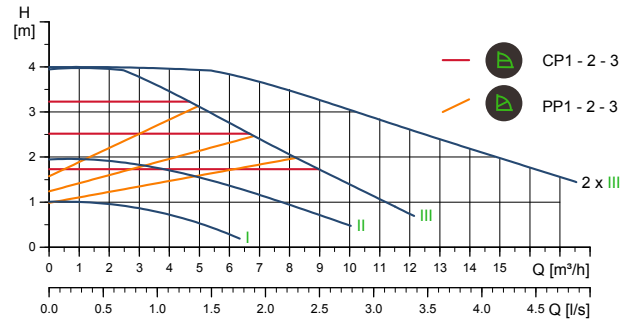

MAGNA1 D 40-60 F

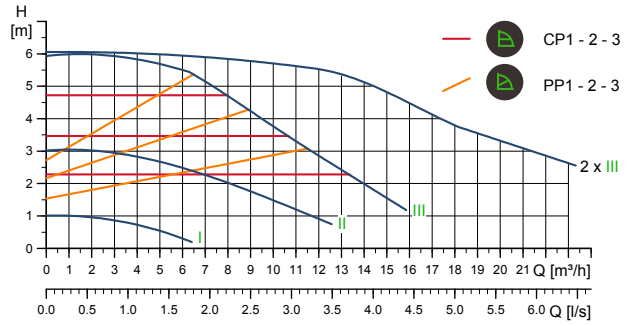

MAGNA1 D 40-80 F

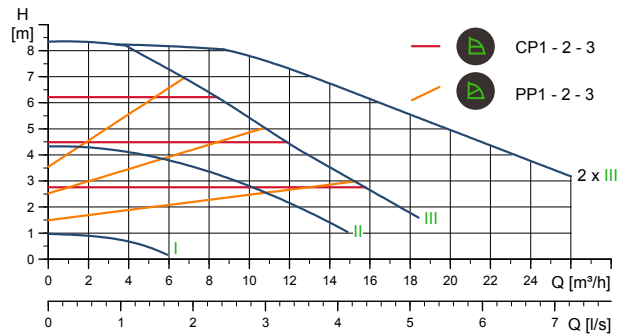

MAGNA1 D 40-100 F

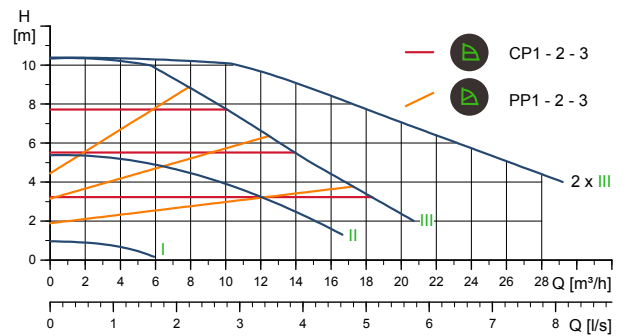

MAGNA1 D 40-120 F

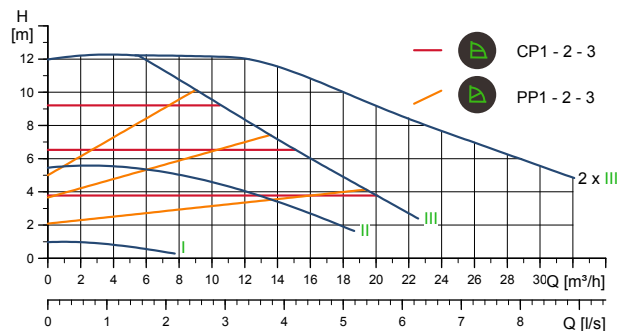

MAGNA1 D 40-150 F

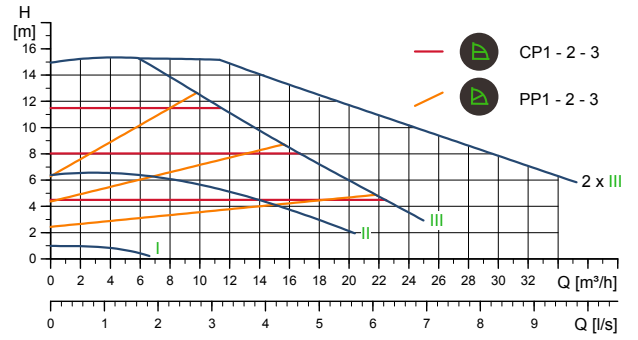

MAGNA1 D 40-180 F

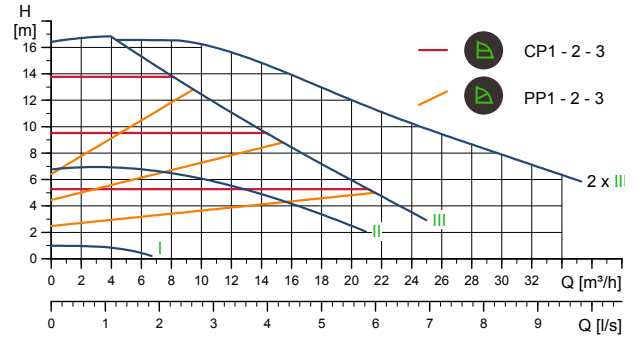

MAGNA1 D 50-40 F

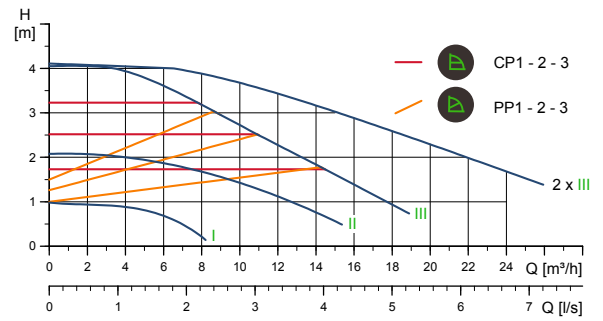

MAGNA1 D 50-60 F

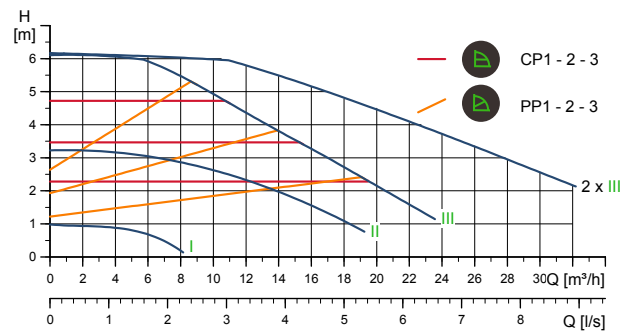

MAGNA1 D 50-80 F

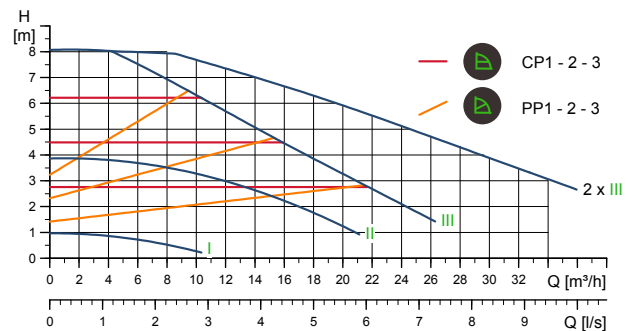

MAGNA1 D 50-100 F

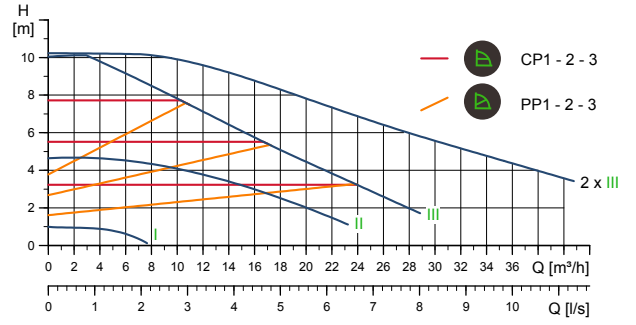

MAGNA1 D 50-120 F

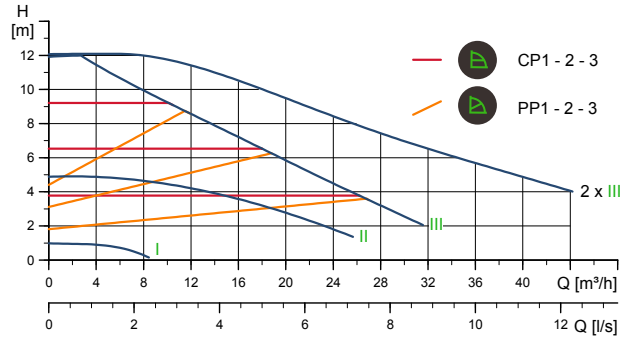

MAGNA1 D 50-150 F

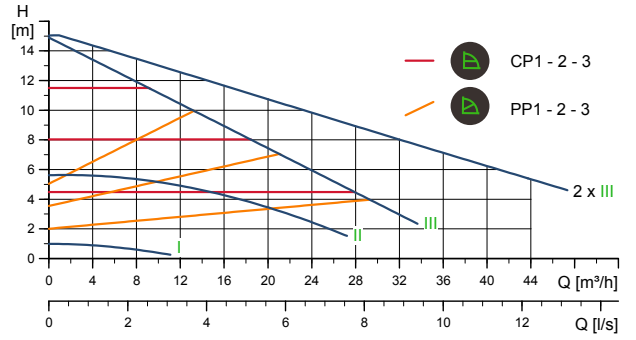

MAGNA1 D 50-180 F

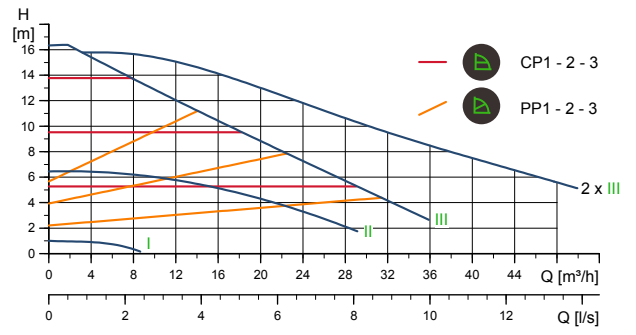

MAGNA1 D 65-40 F

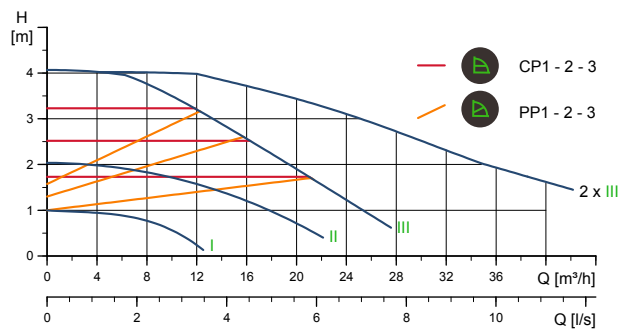

MAGNA1 D 65-60 F

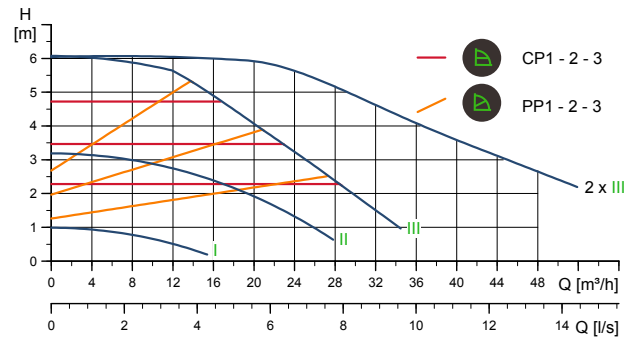

MAGNA1 D 65-80 F

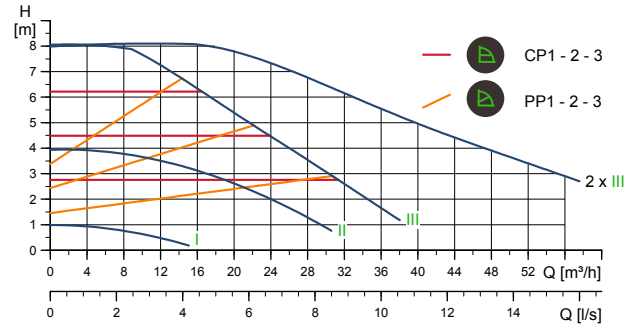

MAGNA1 D 65-100 F

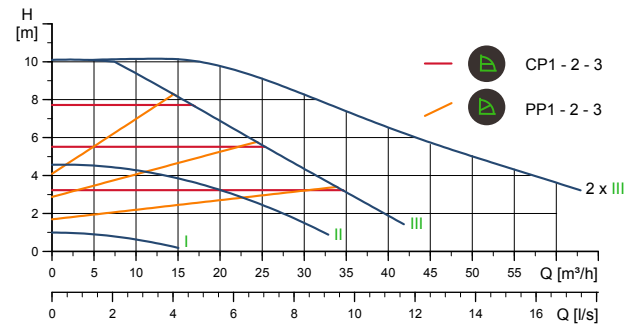

MAGNA1 D 65-120 F

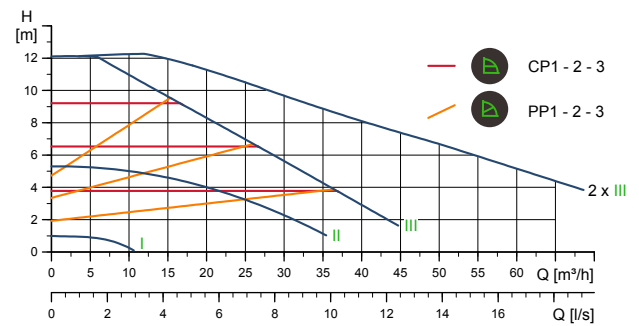

MAGNA1 D 65-150 F

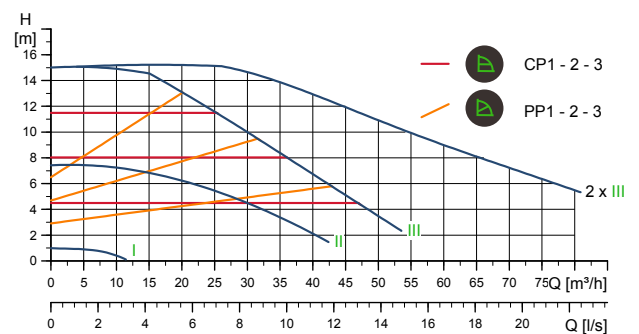

MAGNA1 D 80-40 F

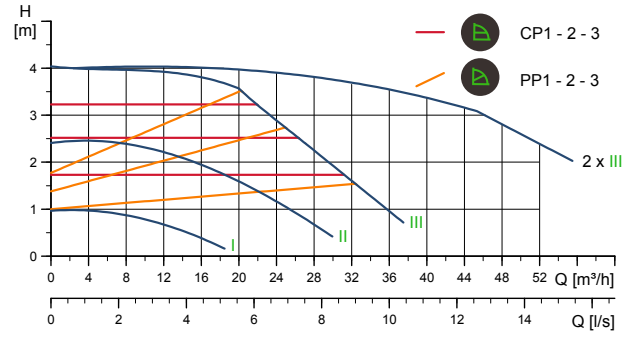

MAGNA1 D 80-60 F

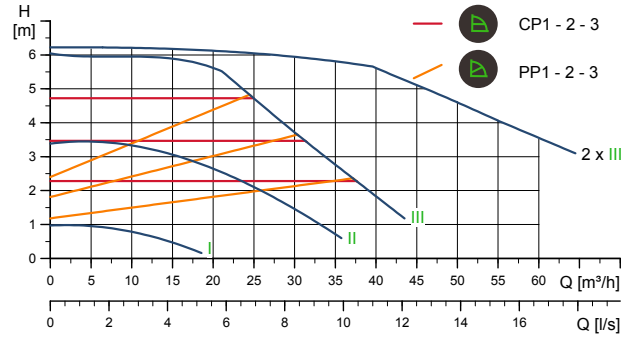

MAGNA1 D 80-80 F

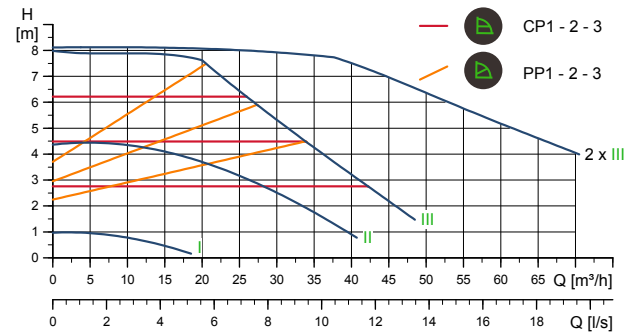

MAGNA1 D 80-100 F

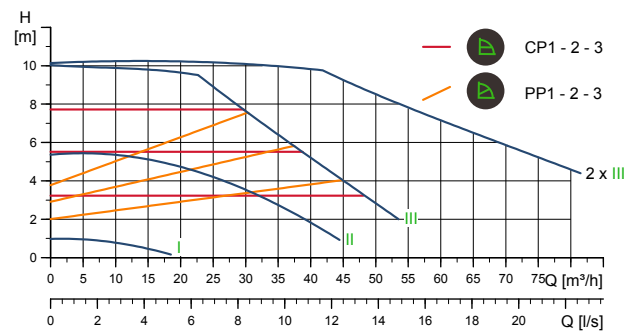

MAGNA1 D 80-120 F

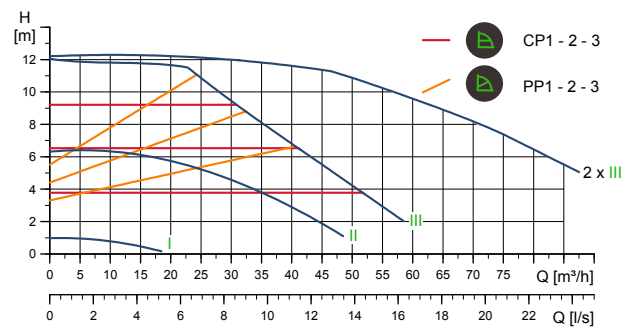

MAGNA1 D 100-40 F

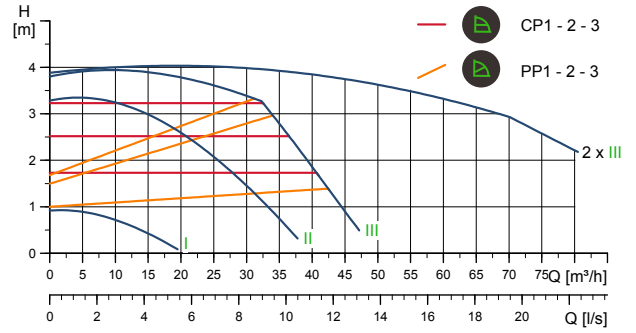

MAGNA1 D 100-60 F

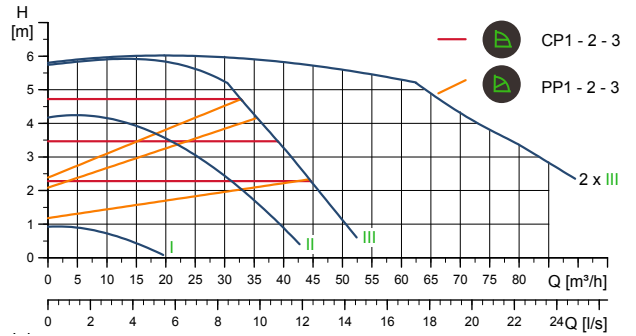

MAGNA1 D 100-80 F

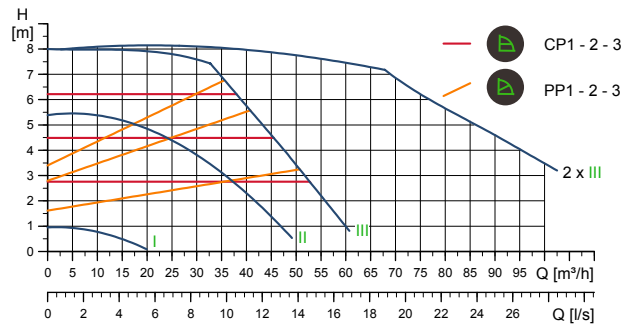

MAGNA1 D 100-100 F

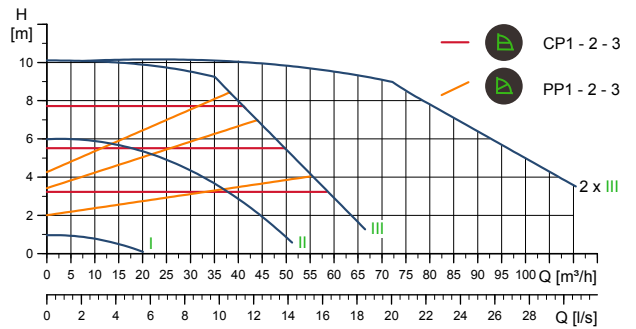

MAGNA1 D 100-120 F

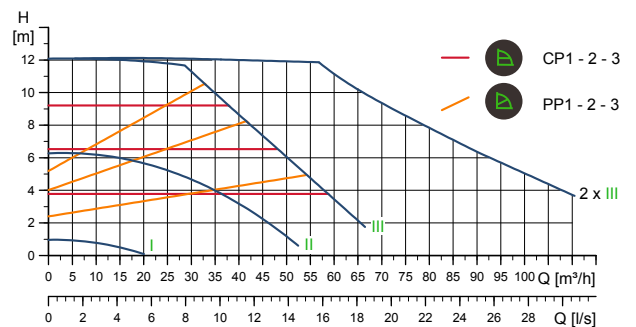

Dimensional drawings

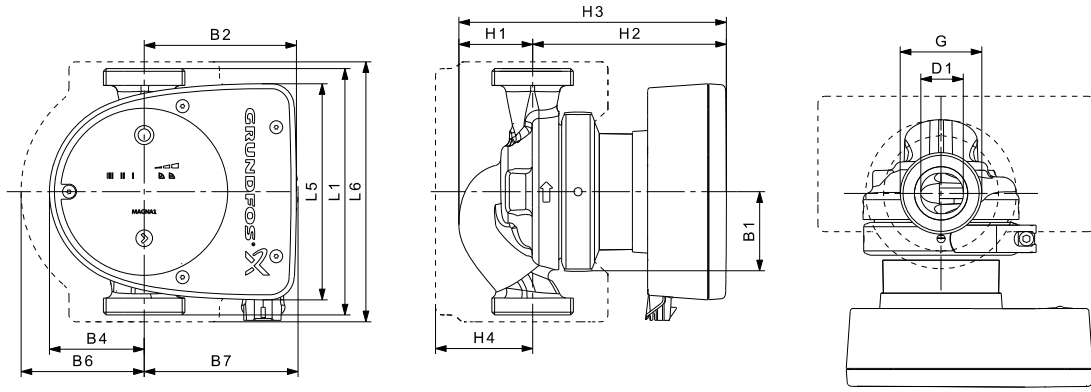

Pump Type	Dimensions (mm)													G (inch)	weight (kg)		Max Amps
	L1	L5	L6	B1	B2	B4	B6	B7	H1	H2	H3	H4	D1		Net	Gross	
MAGNA1 25-40 (N)	180	158	190	58	111	69	90	113	54	142	196	71	25	1½"	4.4	5.4	0.45
MAGNA1 25-60 (N)	180	158	190	58	111	69	90	113	54	142	196	71	25	1½"	4.4	5.4	0.74
MAGNA1 25-80 (N)	180	158	190	58	111	69	90	113	54	142	196	71	25	1½"	4.4	5.4	1.03
MAGNA1 25-100 (N)	180	158	190	58	111	69	90	113	54	142	196	71	25	1½"	4.4	5.4	1.42
MAGNA1 25-120 (N)	180	158	190	58	111	69	90	113	54	142	196	71	25	1½"	4.4	5.4	1.51
MAGNA1 32-40 (N)	180	158	190	58	111	69	90	113	54	142	196	71	32	2"	4.4	5.4	0.59
MAGNA1 32-60 (N)	180	158	190	58	111	69	90	113	54	142	196	71	32	2"	4.4	5.4	0.9
MAGNA1 32-80 (N)	180	158	190	58	111	69	90	113	54	142	196	71	32	2"	4.4	5.4	1.22
MAGNA1 32-100 (N)	180	158	190	58	111	69	90	113	54	142	196	71	32	2"	4.4	5.4	1.41

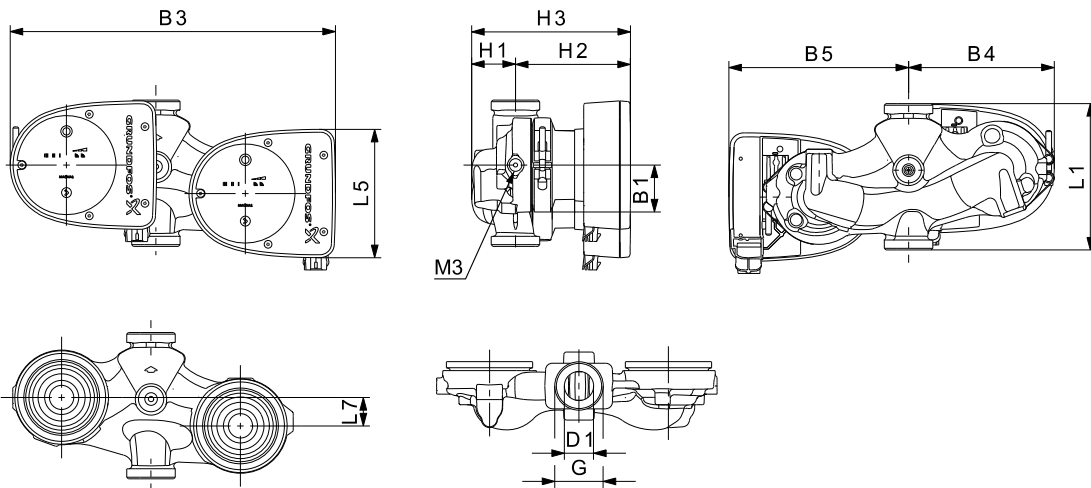

Pump Type	Dimensions (mm)												G (inch)	M3	weight (kg)		Max Amps
	L1	L5	L7	B1	B3	B4	B5	H1	H2	H3	D1	Net			Gross		
MAGNA1 D 32-40	180	158	35	58	400	179	221	54	142	196	32	2"	1/4"	12.4	13.4	0.59	
MAGNA1 D 32-60	180	158	35	58	400	179	221	54	142	196	32	2"	1/4"	12.4	13.4	0.9	
MAGNA1 D 32-80	180	158	35	58	400	179	221	54	142	196	32	2"	1/4"	12.4	13.4	1.22	
MAGNA1 D 32-100	180	158	35	58	400	179	221	54	142	196	32	2"	1/4"	12.4	13.4	1.41	

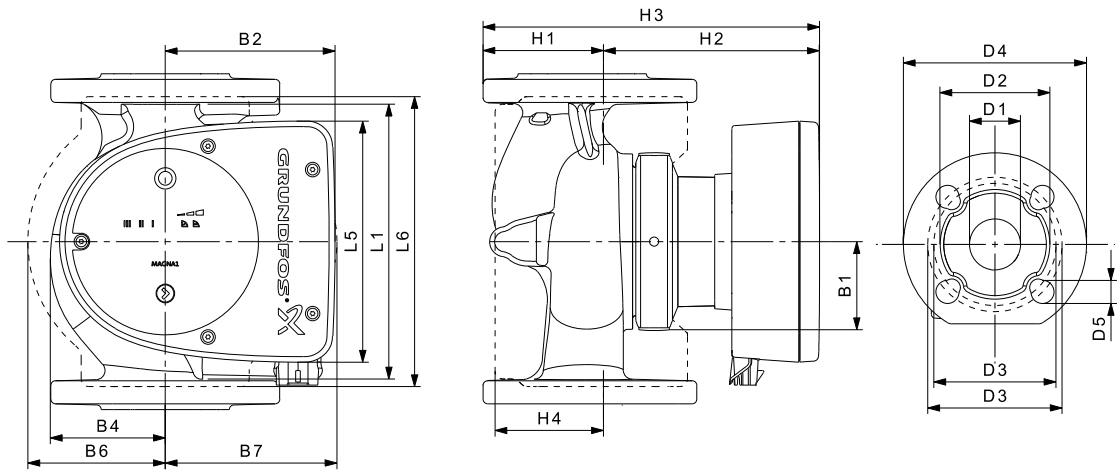

Pump Type	Dimensions (mm)																	weight (kg)		Max Amps
	L1	L5	L6	B1	B2	B4	B6	B7	H1	H2	H3	H4	D1	D2	D3	D4	D5	Net	Gross	
MAGNA1 32-40 F (N)	220	158	220	58	111	69	100	110	65	142	207	82	32	76	90/100	140	14/19	7.4	8.4	0.59
MAGNA1 32-60 F (N)	220	158	220	58	111	69	100	110	65	142	207	82	32	76	90/100	140	14/19	7.4	8.4	0.90
MAGNA1 32-80 F (N)	220	158	220	58	111	69	100	110	65	142	207	82	32	76	90/100	140	14/19	7.4	8.4	1.22
MAGNA1 32-100 F (N)	220	158	220	58	111	69	100	110	65	142	207	82	32	76	90/100	140	14/19	7.4	8.4	1.41
MAGNA1 32-120 F (N)	220	204	216	84	164	73	106	116	65	301	366	86	32	76	90/100	140	14/19	15.4	17.1	1.48
MAGNA1 40-40 F (N)	220	158	220	58	111	69	105	105	65	156	221	83	40	84	100/110	150	14/19	9.5	10.5	0.72
MAGNA1 40-60 F (N)	220	158	220	58	111	69	105	105	65	156	221	83	40	84	100/110	150	14/19	9.5	10.5	1.56
MAGNA1 40-80 F (N)	220	204	220	84	164	73	106	128	65	304	369	83	40	84	100/110	150	14/19	16.5	18.2	1.18
MAGNA1 40-100 F (N)	220	204	220	84	164	73	106	128	65	304	369	83	40	84	100/110	150	14/19	16.5	18.2	1.65
MAGNA1 40-120 F (N)	250	204	220	84	164	73	106	128	65	304	369	83	40	84	100/110	150	14/19	16.2	17.7	2.05
MAGNA1 40-150 F (N)	250	204	220	84	164	73	106	128	65	304	369	83	40	84	100/110	150	14/19	16.2	17.7	2.71
MAGNA1 40-180 F (N)	250	204	220	84	164	73	106	128	65	304	369	83	40	84	100/110	150	14/19	16.2	17.7	2.71
MAGNA1 50-40 F (N)	240	204	240	84	164	73	127	127	71	304	375	97	50	102	110/125	165	14/19	17.7	19.8	0.65
MAGNA1 50-60 F (N)	240	204	240	84	164	73	127	127	71	304	375	97	50	102	110/125	165	14/19	17.7	19.8	1.15
MAGNA1 50-80 F (N)	240	204	240	84	164	73	127	127	71	304	374	97	50	102	110/125	165	14/19	17.7	19.8	1.48
MAGNA1 50-100 F (N)	280	204	240	84	164	73	127	127	72	304	376	97	50	102	110/125	165	14/19	18.2	20.4	1.90
MAGNA1 50-120 F (N)	280	204	240	84	164	73	127	127	72	304	376	97	50	102	110/125	165	14/19	18.2	20.4	2.37
MAGNA1 50-150 F (N)	280	204	240	84	164	73	127	127	72	304	376	97	50	102	110/125	165	14/19	19.1	21.3	2.87
MAGNA1 50-180 F (N)	280	204	240	84	164	73	127	127	72	304	376	97	50	102	110/125	165	14/19	19.1	21.3	3.40
MAGNA1 65-40 F (N)	340	204	296	84	164	73	133	133	74	312	386	94	65	119	130/145	185	14/19	20.7	23.0	0.90
MAGNA1 65-60 F (N)	340	204	296	84	164	73	133	133	74	312	386	94	65	119	130/145	185	14/19	20.7	23.0	1.64
MAGNA1 65-80 F (N)	340	204	296	84	164	73	133	133	74	312	386	94	65	119	130/145	185	14/19	21.6	23.8	2.11
MAGNA1 65-100 F (N)	340	204	296	84	164	73	133	133	74	312	386	94	65	119	130/145	185	14/19	21.6	23.8	2.73
MAGNA1 65-120 F (N)	340	204	296	84	164	73	133	133	74	312	386	94	65	119	130/145	185	14/19	21.6	23.8	3.42
MAGNA1 65-150 F (N)	340	204	296	84	164	73	133	133	74	312	386	94	65	119	130/145	185	14/19	24.3	26.6	5.53

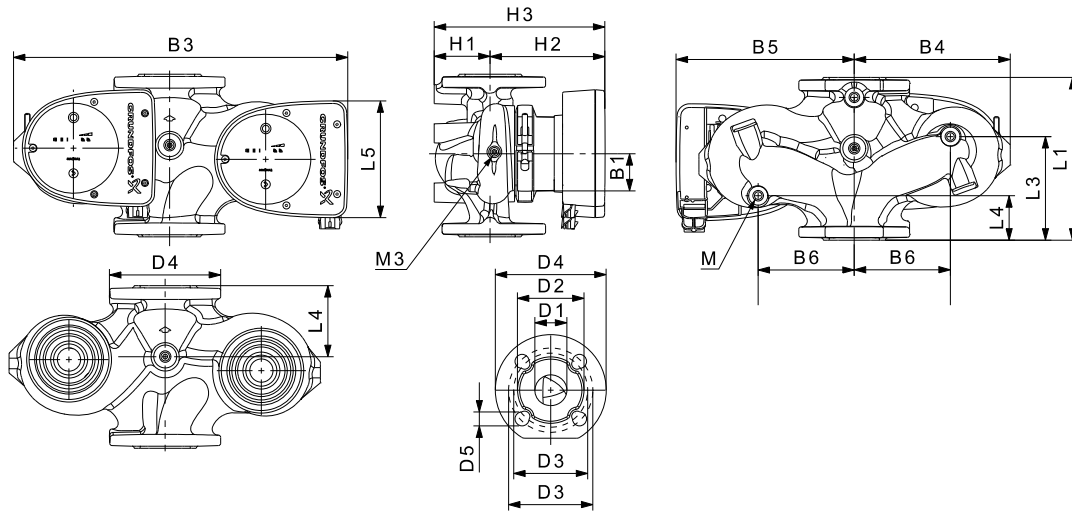

Pump Type	Dimensions (mm)																		Rp	weight (kg)		Max Amps
	L1	L3	L4	L5	B1	B3	B4	B5	B6	H1	H2	H3	D1	D2	D3	D4	D5	M	M3	Net	Gross	
MAGNA1 D 32-40 F	220	120	85	158	58	400	179	221	130	69	142	211	32	76	90/100	140	14/19	M12	1/4"	14.7	15.7	0.59
MAGNA1 D 32-60 F	220	120	85	158	58	400	179	221	130	69	142	211	32	76	90/100	140	14/19	M12	1/4"	14.7	15.7	0.90
MAGNA1 D 32-80 F	220	120	85	158	58	400	179	221	130	69	142	211	32	76	90/100	140	14/19	M12	1/4"	14.7	15.7	1.22
MAGNA1 D 32-100 F	220	120	85	158	58	400	179	221	130	69	142	211	32	76	90/100	140	14/19	M12	1/4"	14.7	15.7	1.41
MAGNA1 D 32-120 F	220	90	50	204	84	502	210	294	130	68	300	368	32	76	90/100	140	14/19	M12	1/4"	29.8	33.7	1.50
MAGNA1 D 40-40 F	220	140	60	158	58	452	211	241	130	76	156	232	40	84	100/110	150	14/19	M12	1/4"	19.0	20.0	0.72
MAGNA1 D 40-60 F	220	140	60	158	58	452	211	241	130	76	156	232	40	84	100/110	150	14/19	M12	1/4"	19.0	20.0	1.56
MAGNA1 D 40-80 F	220	140	60	204	84	502	210	294	130	76	303	379	40	84	100/110	150	14/19	M12	1/4"	32.3	36.2	1.25
MAGNA1 D 40-100 F	220	140	60	204	84	502	210	294	130	76	303	379	40	84	100/110	150	14/19	M12	1/4"	32.3	36.2	1.70
MAGNA1 D 40-120 F	250	155	75	204	84	512	220	294	130	69	303	372	40	84	100/110	150	14/19	M12	1/4"	31.4	35.3	2.10
MAGNA1 D 40-150 F	250	155	75	204	84	512	220	294	130	69	303	372	40	84	100/110	150	14/19	M12	1/4"	31.4	35.3	2.77
MAGNA1 D 40-180 F	250	155	75	204	84	512	220	294	130	69	303	372	40	84	100/110	150	14/19	M12	1/4"	31.4	35.3	2.75
MAGNA1 D 50-40 F	240	160	45	204	84	515	221	294	130	75	304	379	50	102	110/125	165	14/19	M12	1/4"	34.3	42.0	0.65
MAGNA1 D 50-60 F	240	160	45	204	84	515	221	294	130	75	304	379	50	102	110/125	165	14/19	M12	1/4"	34.3	42.0	1.15
MAGNA1 D 50-80 F	240	160	45	204	84	515	221	294	130	75	304	379	50	102	110/125	165	14/19	M12	1/4"	34.3	42.0	1.48
MAGNA1 D 50-100 F	280	75	75	204	84	517	223	294	130	75	304	379	50	102	110/125	165	14/19	M12	1/4"	34.3	42.0	1.93
MAGNA1 D 50-120 F	280	75	75	204	84	517	223	294	130	75	304	379	50	102	110/125	165	14/19	M12	1/4"	34.3	42.0	2.37
MAGNA1 D 50-150 F	280	75	75	204	84	517	223	294	130	75	304	379	50	102	110/125	165	14/19	M12	1/4"	36.1	43.7	2.88
MAGNA1 D 50-180 F	280	75	75	204	84	517	223	294	130	75	304	379	50	102	110/125	165	14/19	M12	1/4"	36.1	43.7	3.46
MAGNA1 D 65-40 F	340	92	92	204	84	522	228	294	130	77	312	389	65	119	130/145	185	14/19	M12	1/4"	38.5	46.0	0.89
MAGNA1 D 65-60 F	340	92	92	204	84	522	228	294	130	77	312	389	65	119	130/145	185	14/19	M12	1/4"	38.5	46.0	1.63
MAGNA1 D 65-80 F	340	92	92	204	84	522	228	294	130	77	312	389	65	119	130/145	185	14/19	M12	1/4"	40.3	47.8	2.11
MAGNA1 D 65-100 F	340	92	92	204	84	522	228	294	130	77	312	389	65	119	130/145	185	14/19	M12	1/4"	40.3	47.8	2.71
MAGNA1 D 65-120 F	340	92	92	204	84	522	228	294	130	77	312	389	65	119	130/145	185	14/19	M12	1/4"	40.3	47.8	3.39
MAGNA1 D 65-150 F	340	92	92	204	84	522	228	294	130	77	312	389	65	119	130/145	185	14/19	M12	1/4"	45.7	53.2	5.62

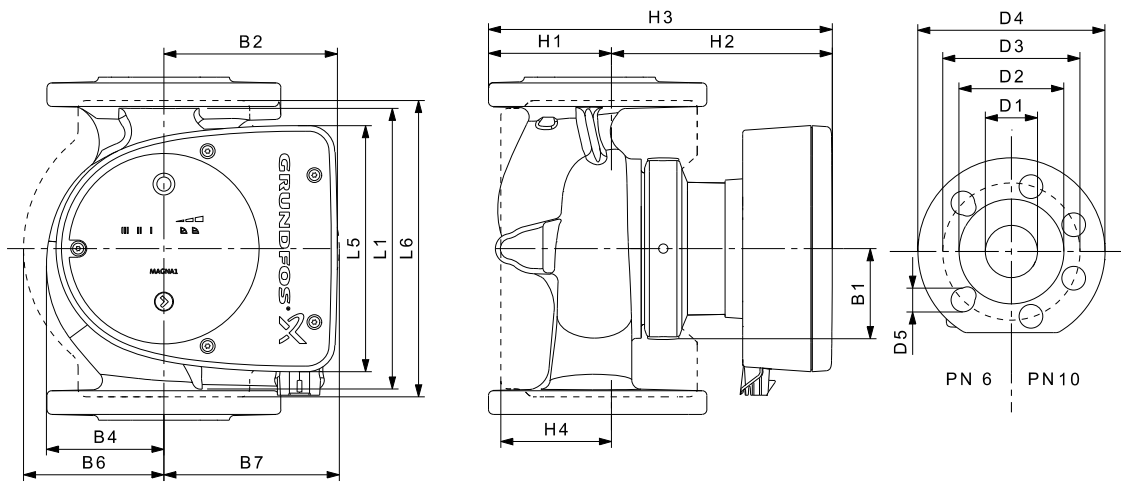

Pump Type	Dimensions (mm)																weight (kg)		Max Amps	
	L1	L5	L6	B1	B2	B4	B6	B7	H1	H2	H3	H4	D1	D2	D3	D4	D5	Net		Gross
MAGNA1 80-40 F	360	204	310	84	164	73	163	163	96	318	413	115	80	128	150/160	200	19	26.8	29.1	1.49
MAGNA1 80-60 F	360	204	310	84	164	73	163	163	96	318	413	115	80	128	150/160	200	19	26.8	29.1	2.37
MAGNA1 80-80 F	360	204	310	84	164	73	163	163	96	318	413	115	80	128	150/160	200	19	29.6	32.0	3.14
MAGNA1 80-100 F	360	204	310	84	164	73	163	163	96	318	413	115	80	128	150/160	200	19	30.2	32.6	4.45
MAGNA1 80-120 F	360	204	310	84	164	73	163	163	96	318	413	115	80	128	150/160	200	19	30.2	32.6	5.59
MAGNA1 100-40 F	450	204	396	84	164	73	178	178	103	330	433	120	100	160	170	220	19	34.2	36.4	2.32
MAGNA1 100-60 F	450	204	396	84	164	73	178	178	103	330	433	120	100	160	170	220	19	34.2	36.4	3.13
MAGNA1 100-80 F	450	204	396	84	164	73	178	178	103	330	433	120	100	160	170	220	19	34.8	37.0	4.71
MAGNA1 100-100 F	450	204	396	84	164	73	178	178	103	330	433	120	100	160	170	220	19	34.8	37.0	6.23
MAGNA1 100-120 F	450	204	396	84	164	73	178	178	103	330	433	120	100	160	170	220	19	34.8	37.0	6.73

Above models rated PN6 as standard

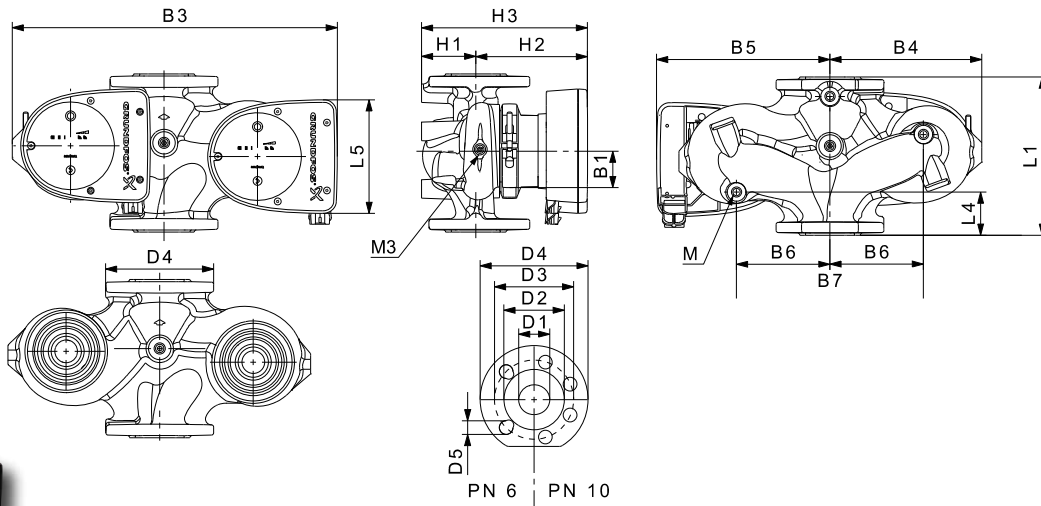

Pump Type	Dimensions (mm)																Rp	weight (kg)		Max Amps	
	L1	L4	L5	B1	B3	B4	B5	B6	H1	H2	H3	D1	D2	D3	D4	D5	M	M37	Net		Gross
MAGNA1 D 80-40 F	360	102	204	84	538	244	294	130	97	318	415	80	128	150/160	200	19	M12	1/4"	45.9	55.7	1.49
MAGNA1 D 80-60 F	360	102	204	84	538	244	294	130	97	318	415	80	128	150/160	200	19	M12	1/4"	45.9	55.7	2.38
MAGNA1 D 80-80 F	360	102	204	84	538	244	294	130	97	318	415	80	128	150/160	200	19	M12	1/4"	51.6	61.3	3.15
MAGNA1 D 80-100 F	360	102	204	84	538	244	294	130	97	318	415	80	128	150/160	200	19	M12	1/4"	52.7	62.5	4.41
MAGNA1 D 80-120 F	360	102	204	84	538	244	294	130	97	318	415	80	128	150/160	200	19	M12	1/4"	52.7	62.5	5.54
MAGNA1 D 100-40 F	450	147	204	84	551	252	299	135	103	330	434	100	160	170	220	19	M12	1/4"	62.1	72.0	2.3
MAGNA1 D 100-60 F	450	147	204	84	551	252	299	135	103	330	434	100	160	170	220	19	M12	1/4"	62.1	72.0	3.11
MAGNA1 D 100-80 F	450	147	204	84	551	252	299	135	103	330	434	100	160	170	220	19	M12	1/4"	62.3	72.2	4.70
MAGNA1 D 100-100 F	450	147	204	84	551	252	299	135	103	330	434	100	160	170	220	19	M12	1/4"	62.3	72.2	6.23
MAGNA1 D 100-120 F	450	147	204	84	551	252	299	135	103	330	434	100	160	170	220	19	M12	1/4"	62.3	72.7	6.71

Above models rated PN6 as standard

Operating Conditions

General recommendations

Water in heating systems	Water quality should be maintained to current industry standards. Systems should be flushed to remove solids. Water treatment should be maintained to ensure system components do not corrode. System pressure should be maintained to prevent air ingress into the system pipework.
Water containing glycol	Max. viscosity = 50 C St = 50% water/50% ethylene glycol at -10°C

Liquid temperature

Application	Temperature range
General	-10°C to +110°C

Ambient conditions

Ambient temperature during operation	0°C to +40°C
Ambient temperature during storage and transport	-40°C to +70°C
Relative air humidity	Maximum 95%

Maximum operating pressure

PN 6: 6 bar / 0.6 MPa

PN 10: 10 bar / 1.0 MPa

Minimum inlet pressure

The following relative minimum inlet pressure must be available at the pump inlet during operation to avoid cavitation noise and damage to the pumps bearings.

Note: The values in the table below apply to single-head pumps and twin-head pumps in single-head operation.

Single-head pumps DN	Liquid temperature		
	75°C	95 °C	110 °C
	Inlet pressure (bar)		
25-40/60/80/100/120	0.10	0.35	1.0
32-40/60/80/100	0.10	0.35	1.0
32-120	0.90	1.30	1.9
40-40/60	0.10	0.35	1.0
40-80/100	0.10	0.50	1.0
40-120/150/180	0.10	0.50	1.0
50-40/60/80	0.10	0.40	1.0
50-100	0.10	0.50	1.0
50-120	0.10	0.50	1.0
50-150/180	0.70	1.20	1.7
65-40/60/80/100	0.70	1.20	1.7
65-120	0.70	1.20	1.7
65-150	0.70	1.20	1.7
80-40/60/80/100/120	0.50	1.00	1.5
100-40/60/80/100/120	0.70	1.20	1.7

In the case of twin-head operation the inlet pressure must be increased by 0.1 bar above the stated values for single-head pumps or twin-head pumps in single-head operation.

Note: Actual inlet pressure plus pump pressure against a closed valve must be lower than the maximum permissible system pressure.

Symbols used on the following pages

The MAGNA1 is energy-optimised and complies with the EuP Directive (Commission Regulation (EC) No 641/2009) which became effective from 1st January 2013, with a further tightening of the legislation in 2015.

For MAGNA1 pumps, the average energy efficiency index (EEI) is ≤ 0.23 with values down to 0.18. From 1st January 2013, the old A to G energy label was replaced by the new energy efficiency index (EEI).

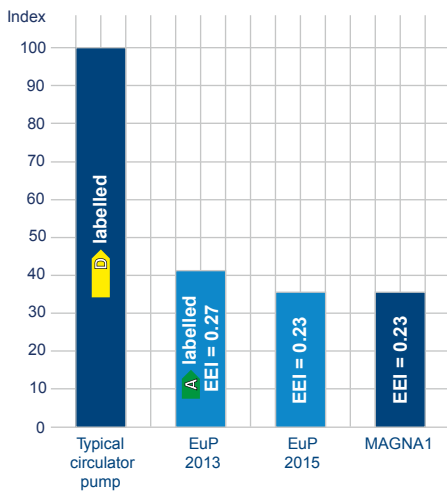

The graph shows the energy consumption index for a typical circulator pump compared to the various EEI limits.

With an energy efficiency index (EEI) equal to the EuP/ErP 2015, you can achieve significant energy savings compared to a typical circulator pump and thus a remarkably fast return on investment.

For more information about the new energy directive, please visit: <http://energy.grundfos.com>

Grundfos blueflux®



The Grundfos blueflux® label is your guarantee that the MAGNA1 incorporates the most energy-efficient motor currently available. Grundfos blueflux® motors are designed to cut the power consumption and thus reduce CO₂ emissions and operating costs.

Comparison chart

The following tables show comparisons of features between the new MAGNA1, MAGNA3 and the preceding MAGNA and UPS product ranges.

MAGNA3 should be compared to the **Magna** range

MAGNA1 should be compared to the **UPS** range.



Curve Options and Control Choices

Feature	MAGNA3	Magna	MAGNA1	UPS
AUTOadapt	✓	✓	✗	✗
FLOWadapt	✓	✗	✗	✗
Flow Limit	✓	✗	✗	✗
Proportional Pressure	✓	✓	✓	✗
Constant Pressure	✓	✓	✓	✗
Fixed Pump Speeds	✓	✓	✓	✓
Night Set Back	✓	✓	✗	✗

Communication

Feature	MAGNA3	Magna	MAGNA1	UPS
Analogue Input	✓	✗	✗	✗
Relay Outputs	✓	✓	✗	✗
Digital Inputs	✓	✓	✗	✗
Infra Red (R100)	✗	✓	✗	✗
Wireless (GO remote)	✓	✗	✗	✗

Twin Pump Control Choices

Feature	MAGNA3	Magna	MAGNA1	UPS
Duty/Standby Rotation	✓	✓	✗	✗
Automatic changeover on fault.	✓	✓	✗	✗
Cascade Option	✓	✗	✗	✗

Table shows product comparison for product replacements of UPS models in the installed base.

UPS Models	Equivalent MAGNA Models	
UPS 25-55	MAGNA1 25-40	MAGNA3 25-40
UPS 25-80	MAGNA1 25-60 to MAGNA1 25-80	MAGNA3 25-60 to MAGNA1 25-80
UPS 25-100	MAGNA1 25-100	MAGNA3 25-100
UPS 32-55	MAGNA1 32-60	MAGNA3 32-60
UPS 32-80	MAGNA1 32-80	MAGNA3 32-80
UPS 32-100	MAGNA1 32-100	MAGNA3 32-100
UPS 40-50	MAGNA1 40-40 F + Spacer 96281076*	MAGNA3 40-40 F + Spacer 96281076*
UPS 40-80	MAGNA1 40-60 F + Spacer 96281076*	MAGNA3 40-60 F + Spacer 96281076*
UPSD 40-50	MAGNA1 D 40-40 F + Spacer 96281076*	MAGNA3 D 40-40 F + Spacer 96281076
UPSD 40-80	MAGNA1 D 40-60 F + Spacer 96281076*	MAGNA3 D 40-60 F + Spacer 96281076*
Single Phase UPS Models	Equivalent MAGNA1 Models	Equivalent MAGNA3 Models
UPS(D) 32-30/4	MAGNA1 (D) 32-40	MAGNA3 (D) 32-40
UPS(D) 32-60/2	MAGNA1 (D) 32-100	MAGNA3 (D) 32-100
UPS(D) 32-120/2	MAGNA1 (D) 32-120	MAGNA3 (D) 32-120
UPS(D) 40-30/4	MAGNA1 (D) 40-40 + Spacer 96281076*	MAGNA3 (D) 40-40 + Spacer 96281076*
UPS(D) 40-60/4	MAGNA1 (D) 40-60 + Spacer 96281076*	MAGNA3 (D) 40-60 + Spacer 96281076*
UPS(D) 40-60/2	MAGNA1 (D) 40-60 + Spacer 96281076*	MAGNA3 (D) 40-60 + Spacer 96281076*
UPS(D) 40-120/2	MAGNA1 (D) 40-120	MAGNA3 (D) 40-120
UPS(D) 40-180/2	MAGNA1 (D) 40-150	MAGNA3 (D) 40-150
UPS(D) 40-185	MAGNA1 (D) 40-180	MAGNA3 (D) 40-180
UPS(D) 50-30/4	MAGNA1 (D) 50-40 + Spacer 96281077**	MAGNA3 (D) 50-40 + Spacer 96281077**
UPS(D) 50-60/4	MAGNA1 (D) 50-60 + Spacer 96281077**	MAGNA3 (D) 50-60 + Spacer 96281077**
UPS(D) 50-60/2	MAGNA1 (D) 50-60 + Spacer 96281077**	MAGNA3 (D) 50-60 + Spacer 96281077**
UPS(D) 50-120/2	MAGNA1 (D) 50-120	MAGNA3 (D) 50-120
UPS(D) 50-180/2	MAGNA1 (D) 50-150	MAGNA3 (D) 50-150
UPS(D) 50-185	MAGNA1 (D) 50-180	MAGNA3 (D) 50-180
UPS(D) 65-30/4	MAGNA1 (D) 65-40	MAGNA3 (D) 65-40
UPS(D) 65-60/4	MAGNA1 (D) 65-60	MAGNA3 (D) 65-60
UPS(D) 65-60/2	MAGNA1 (D) 65-60	MAGNA3 (D) 65-60
UPS(D) 65-120/2	MAGNA1 (D) 65-120	MAGNA3 (D) 65-120

* On these 40mm MAGNA1 and MAGNA3 models an additional spacer kit for replacement purposes may be required.
Code number 96281076.

**On these 50mm MAGNA1 and MAGNA3 models an additional spacer kit for replacement purposes may be required.
Code number 96281077.

DEMAND MORE

DEMAND GRUNDFOS MAGNA3



Demand More Efficiency
Demand More Convenience
Complementing the MAGNA3, Grundfos GO enables easy pump configuration, monitoring and diagnostics using iPhone, iPod Touch or Android mobile devices.



Demand More Cost Saving Functionality

- **AUTOADAPT:** The pump is continually monitoring system conditions as they change over time and making adjustments to the pressure control settings in order to best match the system loads, as they continually change within the building.
- **FLOWADAPT:** In addition to AUTOADAPT function, the maximum flow that the pump can produce is also limited. This reduces the need for specific heating zone commissioning and mechanical flow limitation in the form of a zone commissioning valve.
- **Heat Meter:** By installing a separate temperature sensor into the return pipe the heat energy being consumed in the zone can be monitored. The data can then be retrieved for keeping energy consumption records, fault finding on system controls and valves, and energy optimisation.

Scan the QR code for a video



be
think
innovate

GRUNDFOS

GRUNDFOS PUMPS LTD.

Grovebury Road
Leighton Buzzard
Beds LU7 4TL

Tel: 01525 850000
Email: grundfosuk@grundfos.com
www.grundfos.co.uk

GRUNDFOS 