

Technical Data
HVL2.040-A0010

Item no. **10073L4AA**

Company name
Issued by
Phone number
Fax no.
e-mail address

Receiver

From
Anglian Pumping Services
Joshua Harvey
01473 719950

josh@anglianpumping.com

Product description

Rated output power 4 kW / 1~ 208-240 V (50/60 Hz)
HYDROVAR is an intelligent controller that matches pump performance to demand. It controls the speed of a standard IEC motor by converting the fixed voltage and frequency from the power supply line. It can be fitted easily to any new pump system or retrofitted to existing pumps using the fast and easy "clip and play" mounting clamps. Pump systems are very often oversized for the application and therefore using much more energy than needed. With energy savings of up to 70% at partial loads alone, the typical investment payback period is less than 2 years, depending on energy costs and pump operating times. A motor running at 80% of its maximum speed uses 48% less energy and slashes carbon emissions. The controls available include constant pressure, system curve, constant flow or via an external signal. In addition to these functions HYDROVAR can do things that are normally only performed by the most advanced computerized control systems such as: stopping the pump or pumps at zero demand; stopping the pump or pumps in case of water failure; allowing protection against dry running; a standard feature of a 2nd required input value that allows change over between two different pressure settings via an external switch; sensor failure and over temperature of inverter and motor w protects the pump and motor from under or overvoltage. Other features include: automatic test starts; auto cyclic change of lead and lag pu units; a memory for any inverter fault signals; an operating hours run counter; two of password protection if required.



Dimensions

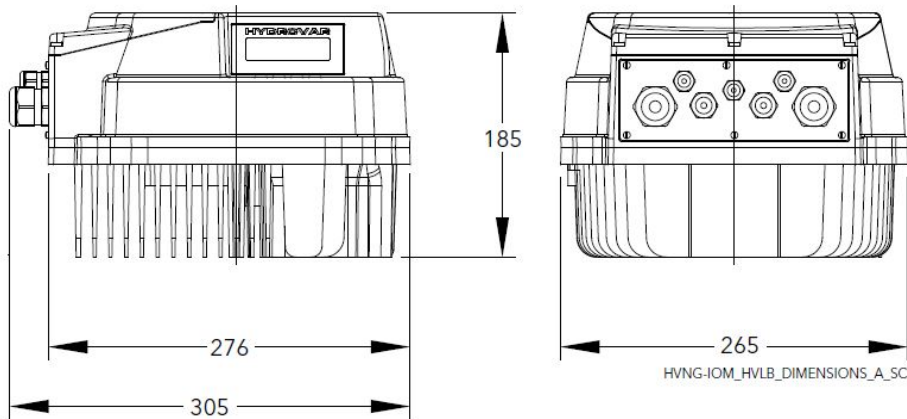

Dimensions and weight without obligation

Project	Project ID	Created by Joshua Harvey	Created on 11/24/2020	Last update 11/24/2020
----------------	-------------------	------------------------------------	---------------------------------	----------------------------------