

Data sheet: VeroLine-IP-E 32/135-1,5/2-R1

Hydraulic data

Minimum efficiency index (MEI)	0.4
Maximum operating pressure p	10 bar
Min. fluid temperature T_{\min}	-20 °C
Max. fluid temperature T_{\max}	120 °C
Min. ambient temperature T_{\min}	0 °C
Max. ambient temperature T_{\max}	40 °C

Materials

Pump housing	EN-GJL-250
Impeller	PPE/PS-GF30
Shaft	1.4021
Shaft seal	AQ1EGG
Lantern	EN-GJL-250

Installation dimensions

Port-to-port length $L0$	260 mm
Pipe connection on the suction side DN_s	DN 32
Pipe connection on the pressure side DN_d	DN 32

Motor data

Mains connection	3~440 V, 50 Hz
Motor efficiency class	IE4
Rated power P_2	1.50 kW
Rated current I_N	5.00 A
Rated speed n	2900 rpm
Max. speed n_{\max}	2900 rpm
Emitted interference	EN 61800-3
Interference resistance	EN 61800-3
Insulation class	F
Protection class motor	IP55

Approved liquids (other liquids upon request)

Heating water (as per VDI 2035)	yes
Heat carrier oil	Special version at additional charge
Cooling and cold water circulation systems	yes
Water-glycol mixtures (at 20 – 40 vol. % glycol and fluid temperature ≤ 40 °C)	yes

Information for order placements

Brand	Wilo
Product description	VeroLine-IP-E 32/135-1,5/2-R1
EAN number	4048482648224
Article number	2158877
Net weight, approx. m	33 kg
Gross weight, approx. m	33.8 kg
Length with packaging	785 mm
Height with packaging	505 mm
Width with packaging	600 mm
Packaging property	Transport packaging
Packaging type	Cardboard box
Minimum order quantity	1

Dimensions and dimensions drawings: VeroLine-IP-E 32/135-1,5/2-R1

VeroLine-IP-E 32/135-1,5/2-R1

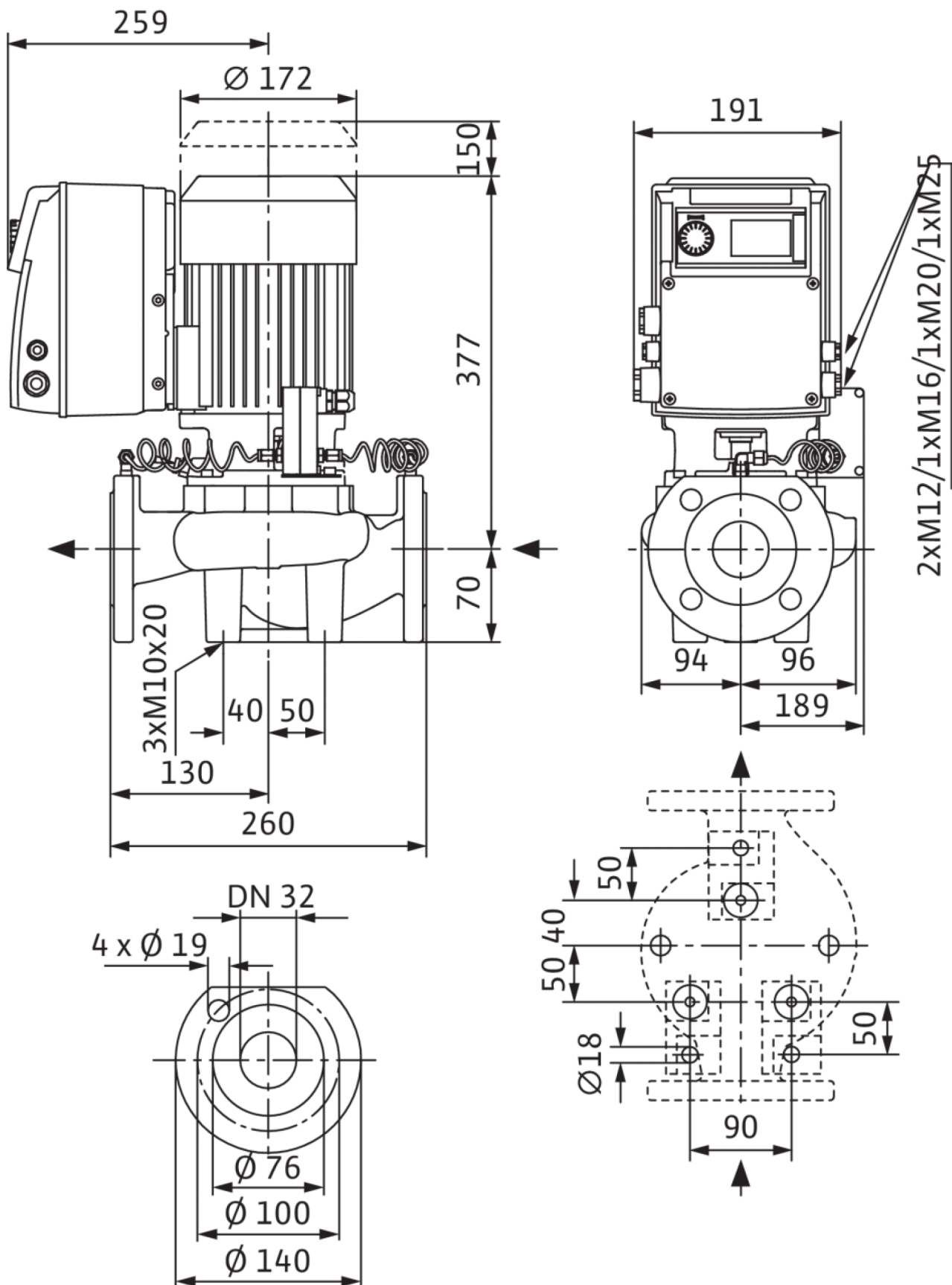

Note:

Housing with feet for installation on a base and drilled holes M10, brackets on request.

Pump curves: VeroLine-IP-E 32/135-1,5/2-R1

VeroLine-IP-E 32/135-1,5/2

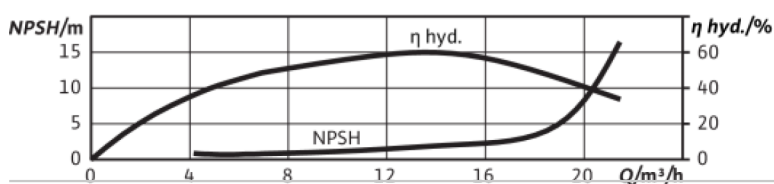
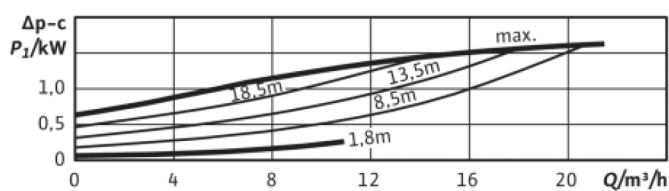
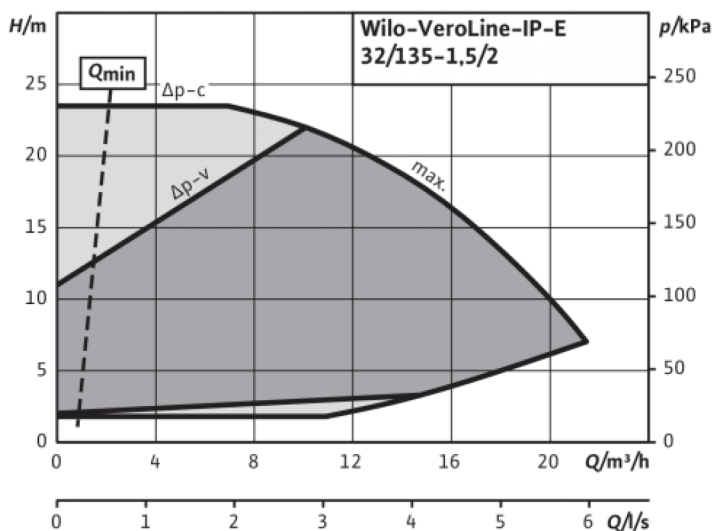
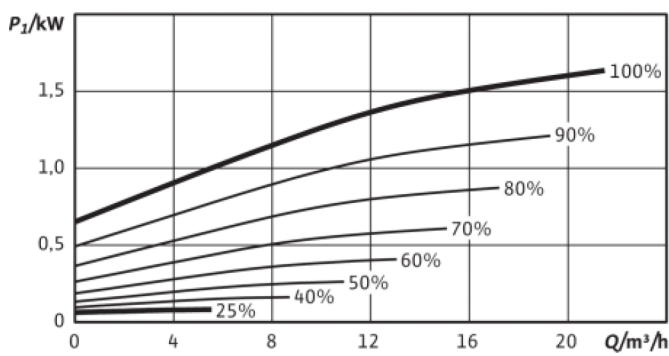
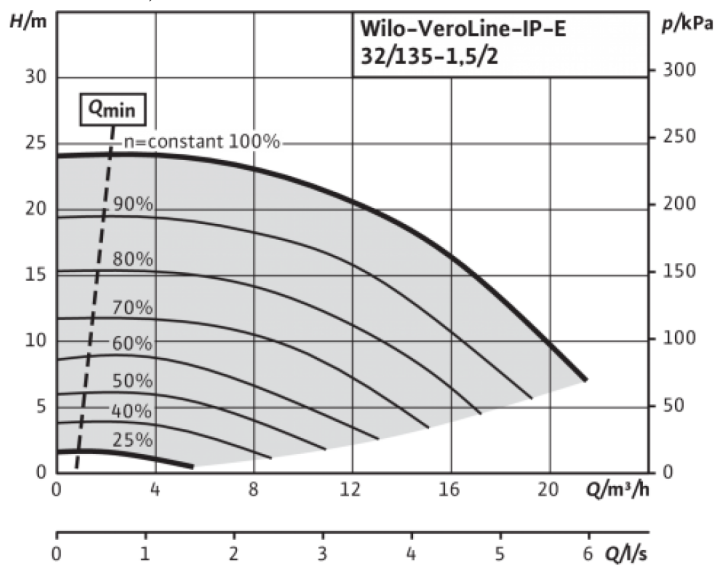

Wiring diagram: VeroLine-IP-E 32/135-1,5/2-R1

IL-E

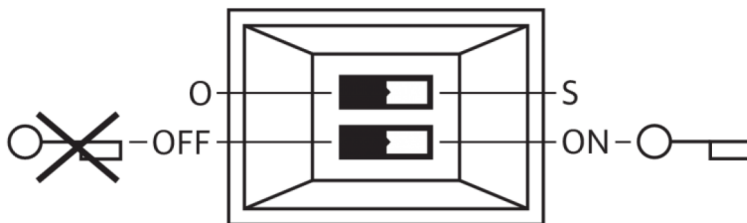
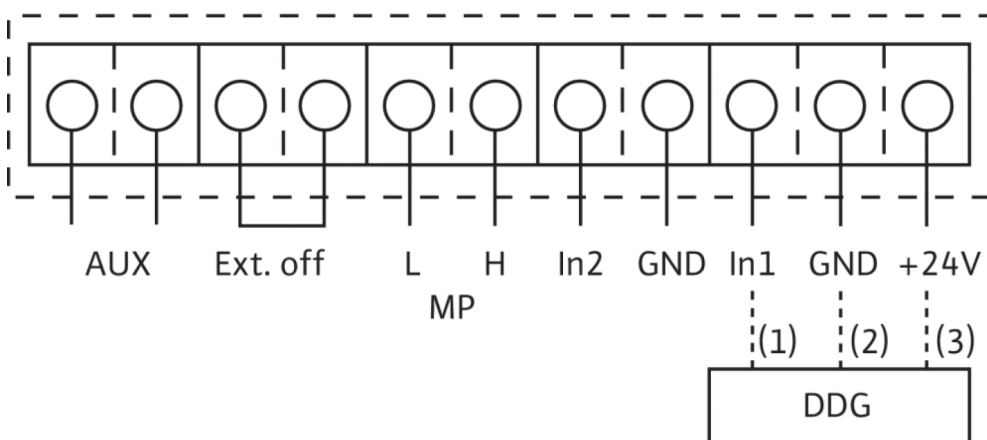
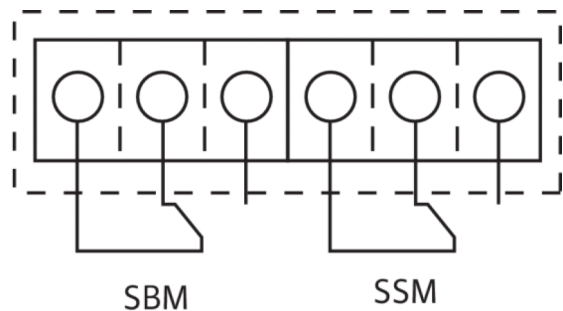
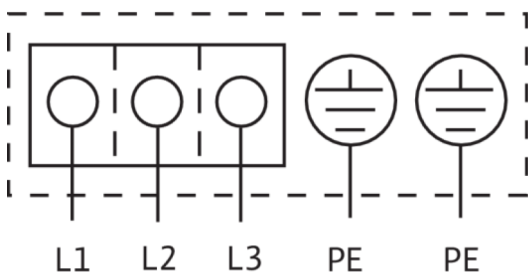

L1, L2, L3:

PE:
DDG:
In1 (1):
GND (2):
+ 24 V (3):
In2:
MP:
Ext. off:

SBM:*
SSM:*
aux:

DIP switch:

Optional:

Mains connection: 3~440 V ±10%, 50/60 Hz; 3~400 V ±10%, 50/60 Hz; 3~380 V -5%/+10%, 50/60 Hz

Protective conductor connection

Connection for differential pressure sensor

Actual value input 0-10 V/0-20 mA; 2-10 V/4-20 mA

Ground connection for In1 and In2

DC voltage output for an external consumer/sensor. Max load 60 mA

Setpoint input 0-10 V/0-20 mA; 2-10 V/4-20 mA

Multi-pump, interface for dual pump management

Control input "Overriding Off" The pump can be switched on or off via an external, potential-free contact (24 V DC/10 mA).

Potential-free collective run signal (changeover contact according to VDI 3814)

Potential-free collective fault signal (changeover contact according to VDI 3814)

External pump cycling (only with dual pump operation). Pump cycling can be performed using an external, potential-free contact (24 VDC/10 mA)

1: Switchover between operation (O) and service mode (S) 2: Activate/deactivate the menu for access disable

IF-Modules for connection to the building automation

* Load capacity of contacts for SBM and SSM:

min.: 12 V DC/10 mA

max.: 250 V AC/1 A