

Receiver

From

Society
Reference
Address
Phone
Fax
E-mail

Item n° :

Model :

1 ESYBOX MAX 60/120 T

Pump data

Pressure rating : 12 bar (1200 KPa)
Constant pressure range: 1-12 bar (3 bar by default)
Min. fluid temperature : 0 °C
Max. fluid temperature : 50 °C
Max. Ambient temperature : 55 °C

Requested data

Flow :
Head :
Fluid : Water
Fluid Temperature : 20 °C
Density : 998,3 kg/m³
Kinematic viscosity : 1,005 mm²/s
Vapor pressure : 2,34 kPa

Materials

Fitting	Technopolymer PA66 30%GF
Manifold	Stainless Steel AISI 304
Flange	Technopolymer PA66 30%GF
Pump body	Technopolymer PA66 30%GF
Pump body ring	Technopolymer PP 30%GF
Impeller	Technopolymer PP 30%GF/AISI 304
Diffuser	Technopolymer PP 30%GF/AISI 304
Motor axis	Stainless Steel AISI 303
OR ring	EPDM
Motor flange	Technopolymer PA66 30%GF
Mechanical seal	Impregnated carbon-resin/Silicon carbide/EPDM
Motor liner	Stainless Steel AISI 304
Motor body	Technopolymer PA66 30%GF
Conveyor tube	Technopolymer PP 30%GF
Pressure sensor	Nylon/EPDM
Non-return valve	POM/EPDM/AISI 302
Non-return valve body	Technopolymer PA66 30%GF
Tank	Noryl/Rubber
Delivery body	Technopolymer PA66 30%GF
Outer liner	Stainless Steel AISI 304

Motor data

Power input P1 : 1 x 2,65 kW
Maximum speed : 5.240 1/min
Rated voltage : 3~ 380-460 V 50 Hz
Nominal current : 1 x 4,2 A
Degree of protection : IP X5

Curve tolerance according to ISO 9906

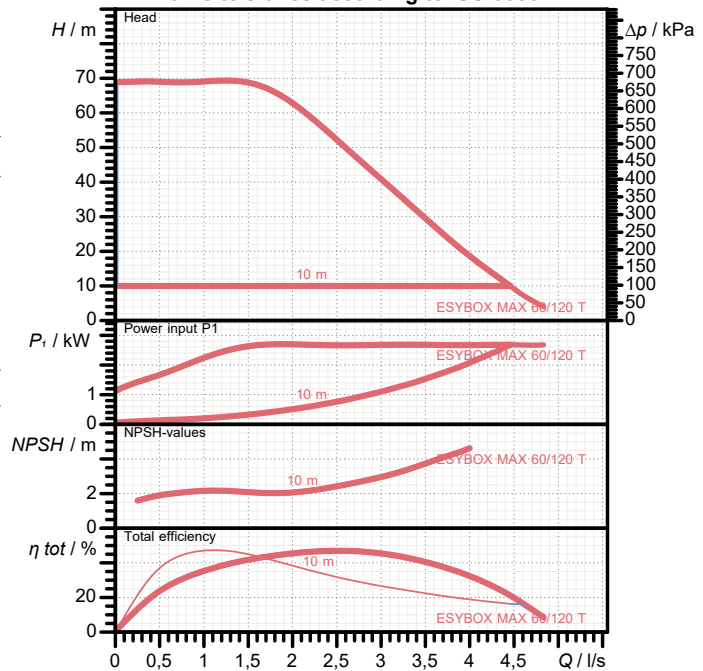

Hydraulic data (duty point)

Flow :
Head :

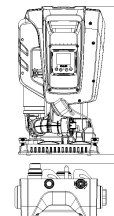
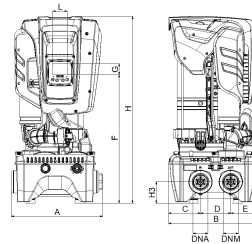

Dimensions in mm

A	375	E	127,7	H3	87		
B	384	F	526	L	59,5		
C	131,8	G	45				
D	124,5	H	766				
DNA	1"1/4 - :	H1	613				
DNM	1"1/4 - :	H2	228				

Weight : 38 kg

Pump connection

Suction side : 1"1/4 - 2" G / 12 bar (1200 KPa)
Discharge side : 1"1/4 - 2" G / 12 bar (1200 KPa)

ENERGY SAVING

BEFORE

AFTER

- **20%**
Compared with
traditional inverter pump

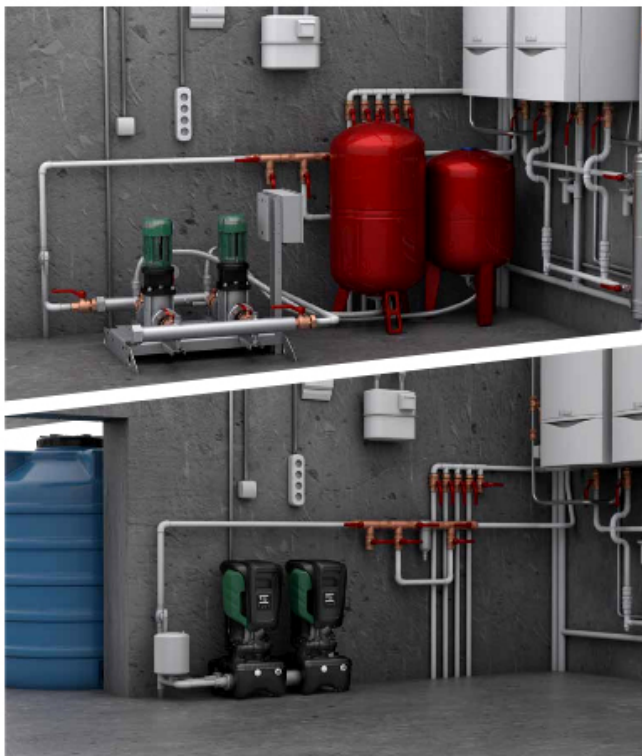

D+CONNECT
BUILT-IN



As quick as a "click"



Receiver

From

Society
Reference
Address
Phone
Fax
E-mail

1 ESYBOX MAX 60/120 T

Curve tolerance according to ISO 9906

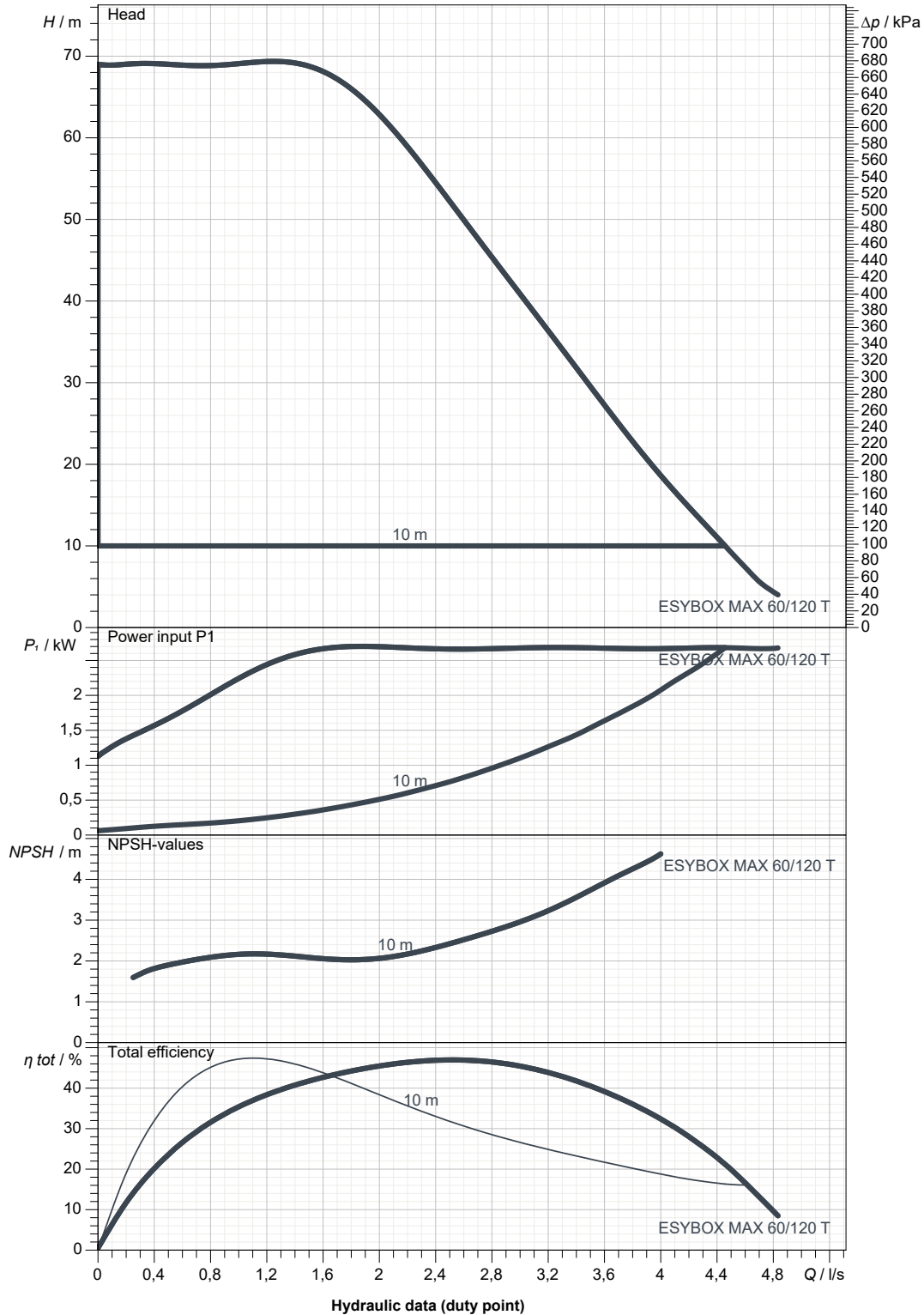

Suction side : 1"1/4 - 2" G 12 bar (1200 KPa)	Discharge side : 1"1/4 - 2" G 12 bar (1200 KPa)	Flow :	Head :	Rated speed : 5.240 1/min
MAIN_PROJECT_TITLE	BUSINESS_PROCESS_ID	OWNER_	ISSUE_DATE 2021-12-16	



DIMENSIONAL DRAWING

2021-12-16

Page 4 / 4

DAB PUMPS S.p.A.
Via Marco Polo, 14 - 35035 Mestrino (PD), Ital
Tel. +39 049 5125000 - Fax +39 049 5125950
www.dabpumps.com

Receiver

From

Society
Reference
Address
Phone
Fax
E-mail

1 ESYBOX MAX 60/120 T

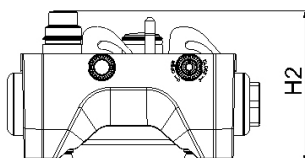
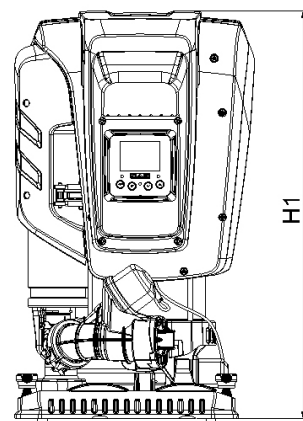
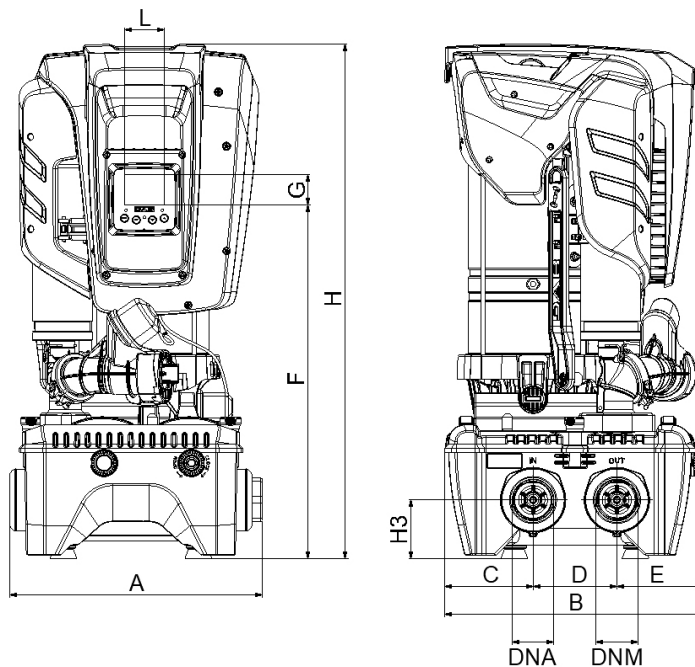

Dimensions in mm

1	A	375
2	B	384
3	C	131,8
4	D	124,5
5	DNA	1"1/4 - 2"
6	DNM	1"1/4 - 2"
7	E	127,7
8	F	526
9	G	45
10	H	766
11	H1	613

H2	228
H3	87
L	59,5

Pump connection

Suction
1"1/4 - 2" G
12 bar (1200 KPa)

Discharge
1"1/4 - 2" G
12 bar (1200 KPa)

MAIN_PROJECT_TITLE

BUSINESS_PROCESS_ID

OWNER_

ISSUE_DATE

2021-12-16