

Chantrol®



POWER WASH



PETROL POWER WASHER

MODEL NO: PLS195B

PART NO: 7330362

OPERATION & MAINTENANCE INSTRUCTIONS



ORIGINAL INSTRUCTIONS

GC0121

INTRODUCTION

Thank you for purchasing this CLARKE Petrol Power Washer.

Before attempting to use this product, please read this manual thoroughly and follow the instructions carefully. In doing so you will ensure the safety of yourself and that of others around you, and you can look forward to your purchase giving you long and satisfactory service.

GUARANTEE

This product is guaranteed against faulty manufacture for a period of 12 months from the date of purchase. Please keep your receipt which will be required as proof of purchase.

This guarantee is invalid if the product is found to have been abused or tampered with in any way, or not used for the purpose for which it was intended.

Faulty goods should be returned to their place of purchase, no product can be returned to us without prior permission.

This guarantee does not affect your statutory rights.

UNPACKING

Unpack your power washer and check to ensure the following items are present. Contact your CLARKE dealer immediately if any parts are missing or damaged.

• Power Washer	• High Pressure Delivery Hose
• Gun/Lance Assembly	• Lance / Nozzle Assembly
• 2 x Wheels	• 2 x Rubber Feet c/w fittings
• Supply (Suction) Hose	• Detergent Hose with filter
• 2 x Axles c/w fittings	• Tommy Bar
• Hose / Lance Storage Bracket	• Spark Plug Box Spanner
• Separate engine user manual	









GENERAL SAFETY RULES



WARNING: WATER AT HIGH PRESSURE CAN BE DANGEROUS AND CAN CAUSE DAMAGE TO PERSONS OR PROPERTY IF THE OPERATOR IS CARELESS. NEVER ALLOW ANYONE TO OPERATE THIS EQUIPMENT UNLESS THEY ARE FAMILIAR WITH THE SAFETY PRECAUTIONS.

1. **DO NOT** point the spray at other people, animals, electrical equipment or the machine itself.
2. **DO NOT** hold your finger over the high pressure nozzle.
3. **DO NOT** let children or untrained personnel use this machine.
4. **DO NOT** try to repair this machine. Always refer to your CLARKE service department for all repairs.
5. **DO NOT** supply any liquid other than water to the water inlet.
6. **DO NOT** use the detergent pickup facility to introduce flammable liquids/ solvents, e.g. paint thinners, petrol, oil as there is a risk of explosion.
7. **ALWAYS** release the remaining pressure in the system; turn off the water supply and operate the trigger before you remove hoses or accessories.
8. **ALWAYS** keep the machine dry and away from the water spray.
9. **ALWAYS** use protective clothing and safety glasses. Loose particles and other items can be propelled at high speed by the water spray.
10. **ALWAYS** hold the gun securely & expect it to 'kick' when you pull the trigger.
11. **ALWAYS** respect the requirements of the local water company. Pressure washers may only be connected to the mains water supply if a system separator (also known as a backflow preventer) is installed in the supply hose.
12. **ALWAYS** disconnect from the water supply and make sure that you drain the system when not in use. Keep in a cool dry location.
13. **ONLY** use detergents that are suitable for pressure washers. We recommend that you use CLARKE Traffic Film Remover or CLARKE Wash and Wax (available from your dealer- see page 14).
14. **WARNING** High pressure water jets can be dangerous, the jet must not be directed at a person or anything that they are wearing.
15. **WARNING** High pressure hoses, fittings and couplings are important for the safety of the machine. Use only hoses, fittings and couplings recommended by the manufacturer.
16. **WARNING** Water that passes through a system separator (also known as a backflow preventer) is not safe to drink.
17. **DO NOT** use the pressure washer if there is damage to the inlet/outlet hose or the machine.

SAFETY SYMBOLS

	<p>ALWAYS: Read this manual and make sure that all warnings and instructions are clear before you use this pressure washer.</p>
	<p>DANGER: Risk of fire or explosion. Stop the engine before you refuel the pressure washer. Keep flammable materials away from the work area. DO NOT spray flammable liquids.</p>
	<p>DANGER: Risk to breathing. Engine exhaust fumes can kill. For outdoor use only. Work in a well ventilated area.</p>
	<p>WARNING: Risk of injection or severe injury. DO NOT directly discharge stream at persons or animals. Keep clear of the nozzle. This machine should only be used by qualified operators.</p>
	<p>WARNING: Risk of spray injury. Spray can propel objects. Always wear ANSI approved Z87.1 Safety Glasses.</p>
	<p>WARNING: Risk of chemical burn. NEVER spray acids, corrosive, or toxic chemicals. Use only cleaners formulated for power washers.</p>
	<p>WARNING: Risk of electrocution. NEVER direct the spray toward any electrical device or electrical outlet.</p>
	<p>WARNING: Risk of unsafe operation. Keep children away from this equipment. Gun kicks back. Hold with both hands.</p>
	<p>WARNING: Risk of hot surfaces. Avoid contact with hot engine exhaust components. DO NOT allow hoses to contact the engine muffler during or after use.</p>

OVERVIEW

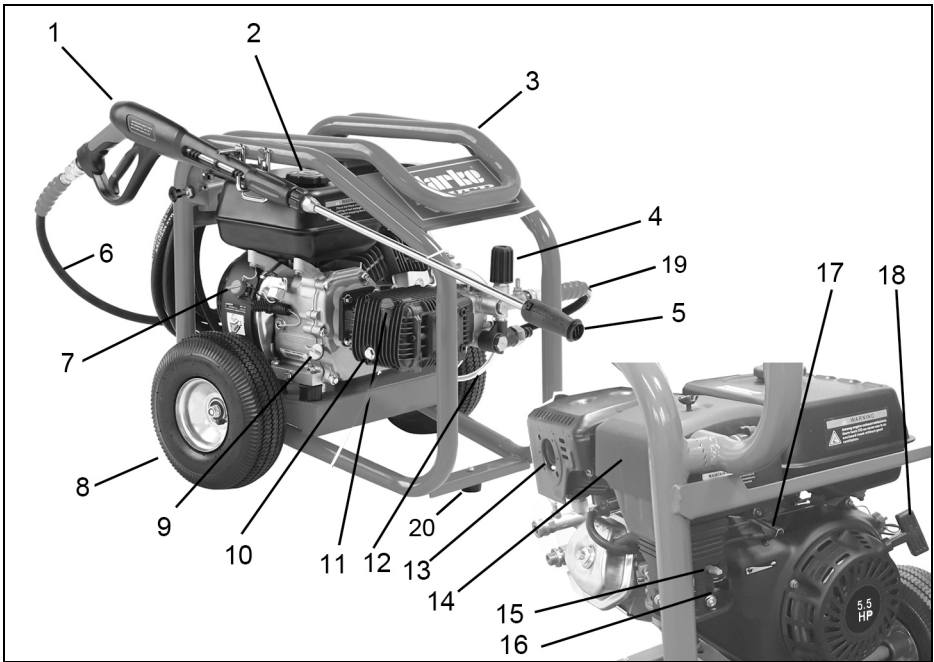

NO	DESCRIPTION
1	Gun/lance
2	Fuel Filler
3	Foldable handle
4	Pressure regulator
5	Adjustable nozzle
6	High pressure delivery hose
7	On/Off Switch
8	Wheel/tyre assembly
9	Engine oil filler
10	Pump oil drain

NO	DESCRIPTION
11	Pump oil filler
12	Chemical (detergent) hose
13	Exhaust muffler
14	Air filter housing
15	Fuel Shut-off Valve
16	Choke
17	Throttle
18	Engine starter
19	Suction hose
20	Rubber foot

ASSEMBLY

FITTING THE WHEELS

1. Fit the axles into the axle ports as shown, secure with the nut, spring washer and flat washer.
2. Fit the wheels to the axles and secure with the nut and washer.

NOTE: DO NOT overtighten the nuts, the wheels must be able to rotate freely.

3. Fit the rubber foot to the leg as shown.

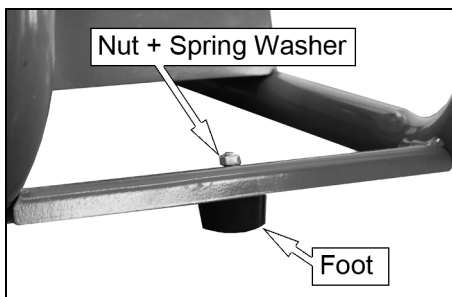
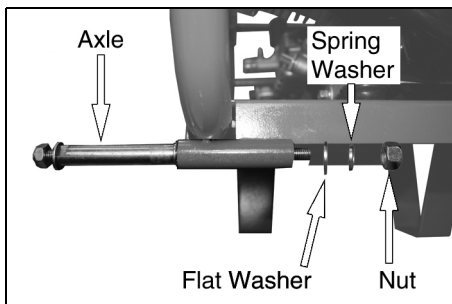

ASSEMBLING THE LANCE

1. Connect the spray wand to the lance and tighten securely.

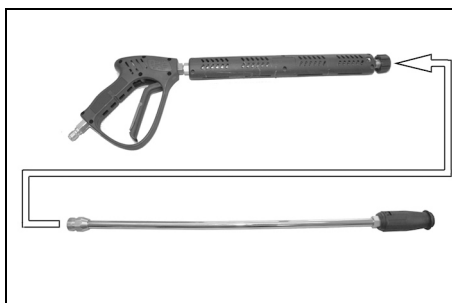

CONNECTING THE HIGH PRESSURE HOSE

CONNECT THE HOSE TO THE GUN

1. Slide the connector on the hose backwards.
2. Push the gun into the connector.
3. Release the connector.
 - Make sure the connection is secure.

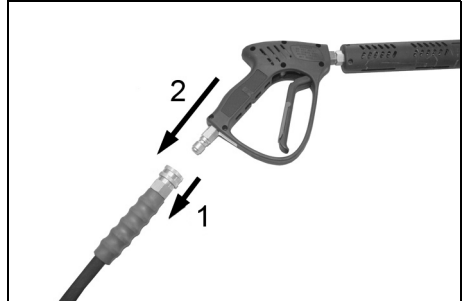

CONNECT THE HOSE TO THE MACHINE

1. Slide the connector on the power washer towards the machine.
2. Push the hose into the connector.
3. Release the connector.
 - Make sure the connection is secure.

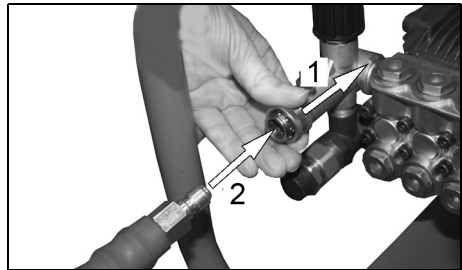

CONNECT WATER INLET HOSE

1. Remove the travel cap if fitted.
2. Connect the water supply hose to the water inlet.

NOTE: Water source must provide a minimum of 5 gallons per minute.

- Make sure the water inlet hose is screwed on tightly.

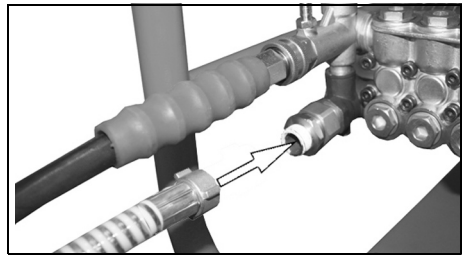

FITTING THE HOSE / LANCE STORAGE BRACKET

1. Fit the bracket into the position shown and secure using the washers and nuts supplied.

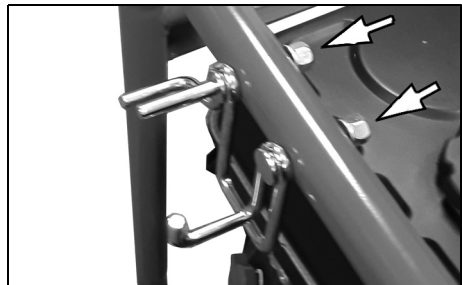

HOSE STORAGE BRACKET

1. Screw a nut and washer onto each leg of the hose bracket.

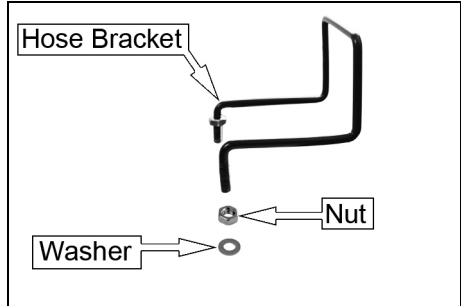

2. Fit the hose bracket in place and secure using a washer, spring washer and nut.

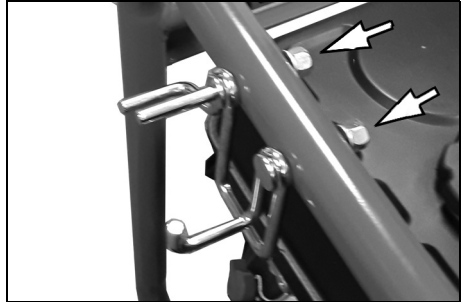

REMOVING THE TRAVEL PLUG

1. Remove the red travel plug before use.
2. Inside the small bag attached is the oil filler cap which needs to be fitted in its place.

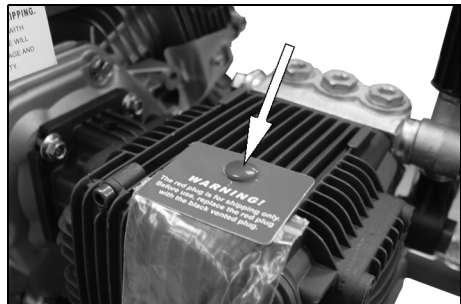

BEFORE USE



WARNING: TO CARRY OUT THIS CHECK, STAND THE POWER WASHER ON LEVEL GROUND WITH THE ENGINE OFF.

WARNING: TAKE CARE NOT TO TOUCH ANY HOT COMPONENTS WHEN CHECKING THE OIL LEVELS.

IMPORTANT: The engine is supplied without any oil in it and must be filled to the correct level before use, see below.

CHECKING THE PUMP OIL LEVEL

The sight glass on the pump displays the oil level inside.

If required, top up with oil. See Changing the Pump Oil on page 16.

- We recommend the use of SAE30 oil in this pump.

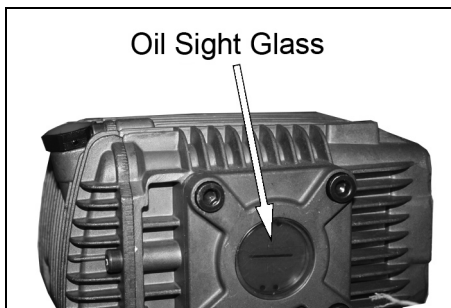

CHECKING ENGINE OIL LEVEL

1. Turn the oil filler cap/dipstick anti-clockwise and remove it from the oil filler tube. Wipe the dipstick with a clean cloth.
2. Insert the oil filler cap/dipstick back into the oil filler tube and then remove it again. DO NOT screw it in when doing this.
3. If the oil is low, fill the oil reservoir to the edge of the oil filler hole.
 - We recommend the use of SAE30 oil in the engine.
4. Replace the oil filler cap.

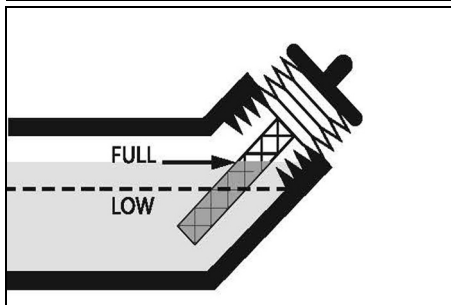
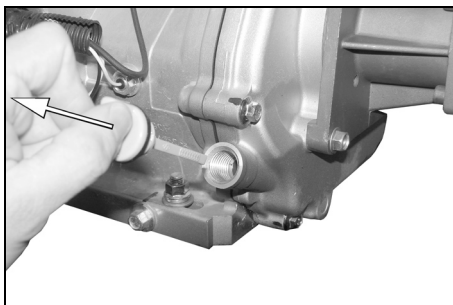

CAUTION: RUNNING THE ENGINE WITH INSUFFICIENT OIL CAN CAUSE ENGINE DAMAGE.

CHECKING THE FUEL LEVEL

1. To check the fuel level remove the fuel tank cap.
2. Just inside the fuel tank is a fuel strainer. Check this filter periodically and remove any contaminants which may have accumulated.
3. Refuel in a well-ventilated area, before starting the engine. If the engine has been running, allow it to cool. Refuel carefully to avoid spilling fuel. **DO NOT** fill above the fuel strainer shoulder.
4. After refueling replace the fuel filler cap securely.

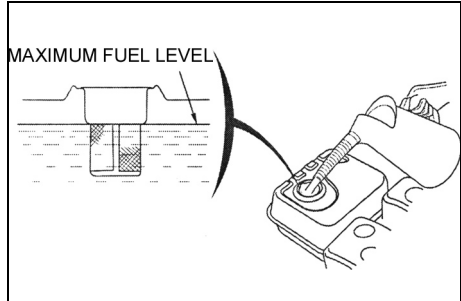

RECOMMENDED FUEL

Use unleaded petrol with an octane rating of 86 or higher. **DO NOT** overfill.



WARNING: ALWAYS REFUEL IN A WELL VENTILATED AREA AWAY FROM ANY HEAT SOURCE.

WARNING: ALLOW THE UNIT TO COOL DOWN BEFORE REFUELLING.

WARNING: DO NOT LEAVE FUEL WITHIN THE REACH OF CHILDREN.

ADJUSTING THE PRESSURE REGULATOR

When supplied, the pressure regulator may be set to minimum.

Turn the pressure regulator on the pump fully clockwise to allow water pressure to build up when the pressure washer is running.

If you find the pressure is too high you can adjust this later.

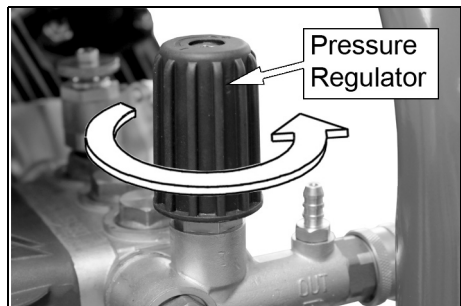

DESIGN FEATURES

Bypass mode: In bypass mode, the pump recirculates the water because the trigger of the spray gun is not being pulled. If unit is left in bypass mode for more than two minutes, the water temperature will rise to a dangerous level and could damage internal components of the pump.

NOTE: Any damage to the pump due to these causes will not be covered under warranty.

Thermal Relief Valve: In an effort to prevent extreme damage, pumps are equipped with a thermal relief valve. This valve will open when the temperature inside the pump becomes too high. This valve will then release a gush of water in an effort to lower the temperature inside the pump. Immediately after this occurs, the valve will close.

Chemical Injection System: This mixes cleaners or cleaning solvents with the pressurised water to improve cleaning effectiveness.

STARTING THE MACHINE

Prior to starting, refer to your engine manual for proper starting procedures for your engine type.

1. Make sure the engine has sufficient fuel. See page 10.
 2. Check the engine oil level. See page 9.
 3. Turn water supply on.
-



WARNING: FAILURE TO TURN ON THE WATER COULD CAUSE DAMAGE TO THE PUMP.

4. Set the engine switch to 'ON'.

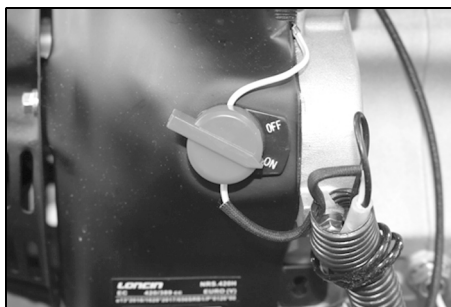

- Set the fuel valve lever to the 'ON' position.

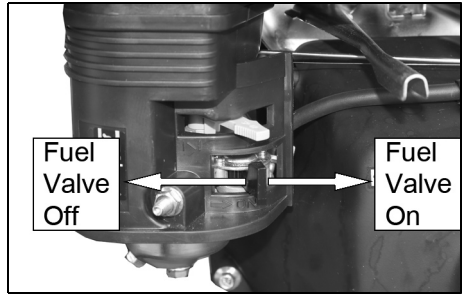

- If you are starting the power washer 'cold' set the choke lever to the CHOKE position (left). If the power washer is warm skip this step.

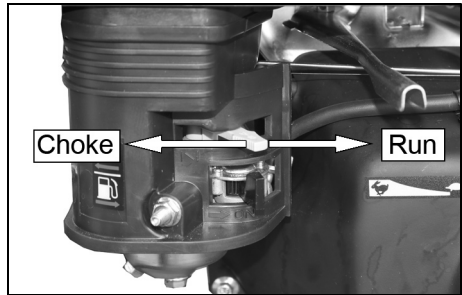

- Set the throttle to the 1/3rd of the way towards the fast setting.

- Pull the starting handle lightly until you start to feel resistance and then pull up sharply to start the power washer.

NOTE: You may have to do this more than once.



WARNING: ONCE THE POWER WASHER HAS STARTED, RELEASE THE STARTING HANDLE SLOWLY TO AVOID INJURY/DAMAGE AS IT WHIPS BACK.

- Once the engine has warmed up, set the choke lever to the 'RUN' (right) position.

NOTE: If the engine does not start after two pulls, pull the trigger on the gun to relieve the pressure.

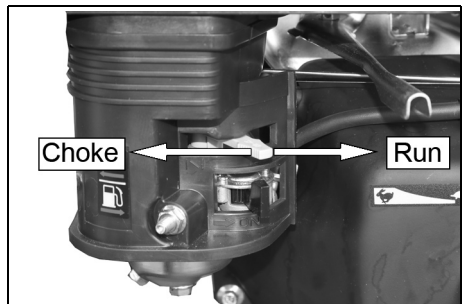

USING THE POWER WASHER

1. Pull the trigger on the gun to start water flow.
 - Stand on a stable surface and grip the gun/spray wand firmly with both hands.
 - Expect the gun to kick when the trigger is pulled.
2. Release trigger to stop the water flow.

NOTE: The power washer will automatically go into bypass mode. In bypass mode, the pump recirculates the water because the trigger of the spray gun is not being pulled. If the unit is left in bypass mode for more than two minutes, the water temperature will rise to a dangerous level and could damage the internal components of the pump.



WARNING: DO NOT ALLOW THE UNIT TO OPERATE IN BYPASS MODE FOR MORE THAN TWO MINUTES AT ANY TIME.

ADJUSTING THE SPRAY

The nozzle is adjustable to allow you to change the spray from a narrow jet of water to a wide spray.

TO ADJUST THE NOZZLE:

1. Hold the shaft of the lance and twist the nozzle with the other hand.
2. To vary the spray between narrow and wide, turn the nozzle counter-clockwise through a half-of-a-turn.

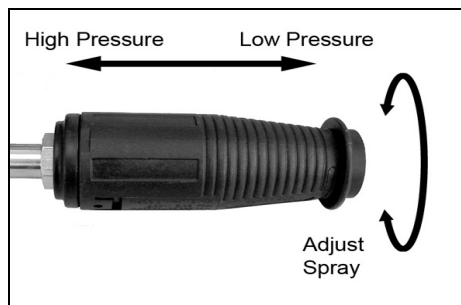

ADJUSTING THE PRESSURE

1. Adjust the pressure regulator on the pump. Turn the pressure regulator knob counter clockwise to lower pressure. Once you have finished work, return the pressure regulator to its original position.
2. Back away from the surface to be cleaned. The further away you are the less the pressure will be on the surface being cleaned.
3. Reduce the speed of the engine. Slow the engine down and the water pressure will drop.
4. Adjust the spray to a wider angle.
5. Slide the nozzle forward for low pressure and backwards for high pressure.

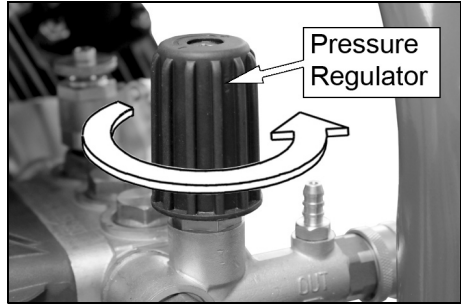

USING CHEMICALS AND CLEANING SOLVENTS

1. Push the chemical hose onto the ridged fitting as shown.
2. Place the other end of the chemical hose with the filter on it, into a container holding the chemical/cleaning solution.
3. Slide the nozzle forward for low pressure operation.
 - The water/chemical ratio is typically 7:1, for every 7 gallons of water pumped 1 gallon of chemical/cleaning solution will be used.
4. The following products are available from your CLARKE dealer.

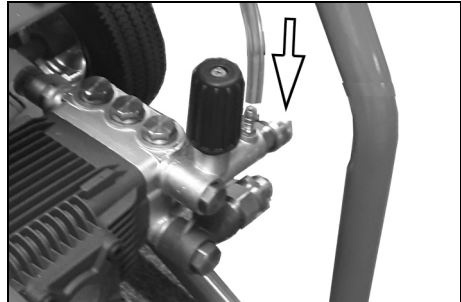

TRAFFIC FILM REMOVER			
5 ltr	Concentrate	Part number	3050821
25 ltr	Concentrate	Part number	3050820
5 ltr	Ready to use	Part number	3050818
25 ltr	Ready to use	Part number	3050819
CAR WASH & WAX			
5 ltr	Wash and wax	Part number	3050815



WATER BUTT CONNECTION

This machine has the ability to draw its own water, meaning you can use water not under pressure, such as rainwater collected in a water butt.

To do this you must carry out the following procedure.

1. Attach the filter to the end of the pipe supplied.
2. Place the filter into the water butt.

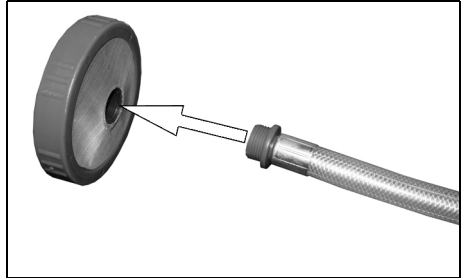

3. Replace the fitted inlet connector with the inlet connector supplied.
4. Connect the pick-up pipe to the pressure washer as shown.
 - Tighten securely.

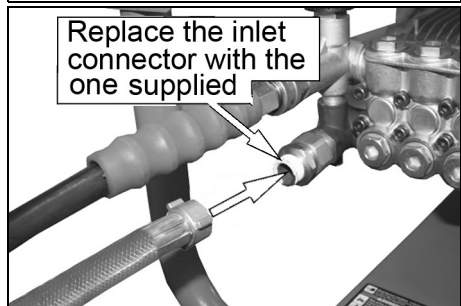

5. Open the suction valve shown.
6. Start the power washer as shown on page 11.
 - Water is ejected from the nozzle as shown.

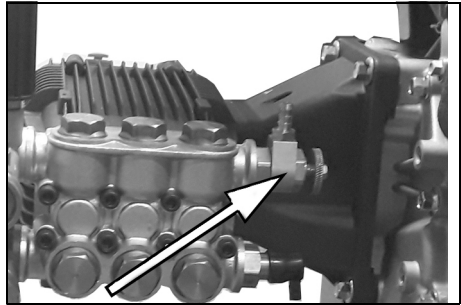

7. When the water spray being ejected is consistent and at high pressure close the self suction valve.
8. Use the pressure washer as normal.
 - DO NOT let the pressure washer run dry.

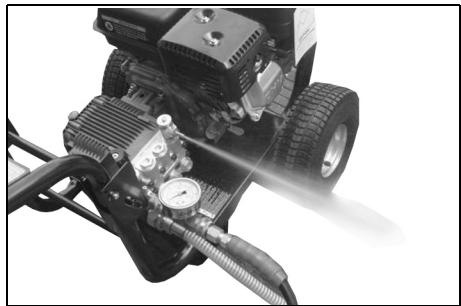

SHUTTING DOWN

1. After each use, if you have applied chemicals, place the chemical hose into a container of clean water and run clean water through the chemical injection system to flush the system thoroughly.

NOTE: Failure to do so could cause damage to the pump.

2. Turn the engine off. See engine owner's manual.

NOTE: NEVER turn the water off with the engine running.

3. Turn the water supply off.
4. Pull the trigger on the spray gun to relieve any water pressure.
5. See storage section in this manual for proper storage procedures.

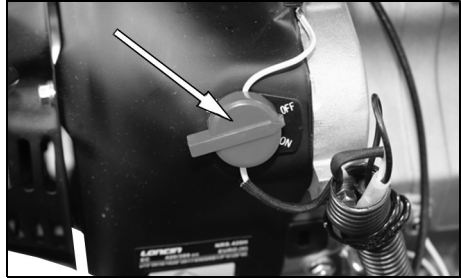

MAINTENANCE

CHANGING THE PUMP OIL



CAUTION: PROLONGED EXPOSURE TO USED OIL IS DANGEROUS, ALWAYS WASH YOUR HANDS THOROUGHLY AFTER HANDLING USED OIL.

1. Unscrew and remove the oil filler cap.
2. Place an oil collection tray (not supplied) under the drain plug.
3. Unscrew the drain plug, and allow the used oil to drain from the crankcase into the oil collection tray.

NOTE: Drain the oil when the engine is warm, this will ensure the oil flows out quicker.

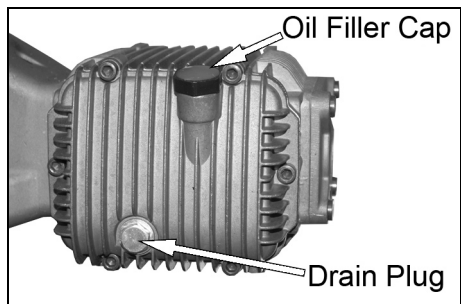

4. Replace the drain plug and its ring seal.
5. With the power washer in a level position, fill to the centre of the sight-glass with the recommended oil.
6. Replace the oil filler cap.



ENVIRONMENTAL PROTECTION

One of the most damaging sources of pollution is oil. DO NOT throw away used oil with your domestic rubbish or down drains and sinks. Place it in a leak proof container and take it to your local waste disposal site.

CLEANING THE NOZZLE

If the nozzle becomes partially clogged or restricted by dirt or other foreign material, excess pump pressure may develop. Clean the nozzle immediately by following the instructions below.

1. Shut off the power washer and turn off the water supply.
2. Pull the trigger on the gun handle to relieve any water pressure.
3. Disconnect the spray wand from the gun.
4. Remove any obstructions and back flush with clean water.
5. Direct the water supply into the spray wand end for 30 seconds to back flush loosened particles.
6. Reconnect the spray wand to the gun and turn on the water supply.

CLEANING THE WATER INLET

This water inlet should be checked regularly and cleaned if necessary.

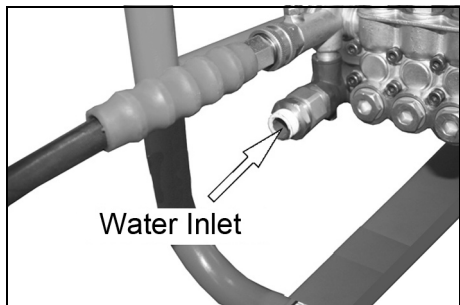

1. Remove any fittings to the water inlet.
2. Remove the water filter from the water inlet.
3. Clean the filter by flushing it with water on both sides.
4. Replace the water filter.

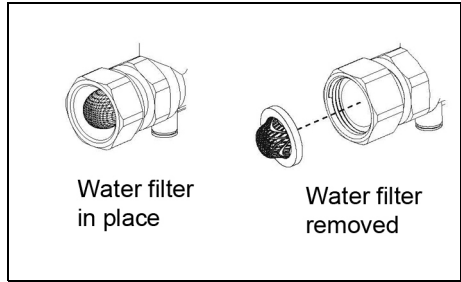

CHANGING THE SPARK PLUG



CAUTION: ALLOW THE ENGINE TO COOL BEFORE REMOVING THE SPARK PLUG.

1. Remove the spark plug cap/lead from the spark plug.
2. Use the spark plug spanner, supplied, to remove the spark plug.
3. Remove any carbon that has accumulated around the electrode.
4. Check the spark plug gap (a) and adjust if necessary.
 - It should be between 0.7 and 0.8 mm
5. Check the overall condition of the spark plug and replace if poor.
6. Reinstall the spark plug and refit the spark plug cap.

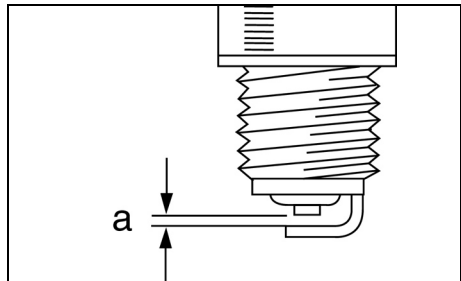
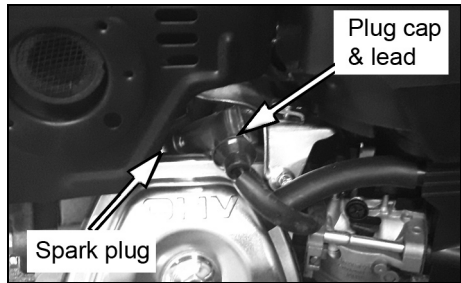

CHECKING THE AIR FILTER



CAUTION: DO NOT USE THE GENERATOR WITHOUT THE AIR FILTER FITTED, THIS CAN DAMAGE THE ENGINE.

1. Remove the wingnut and remove the air filter cover.

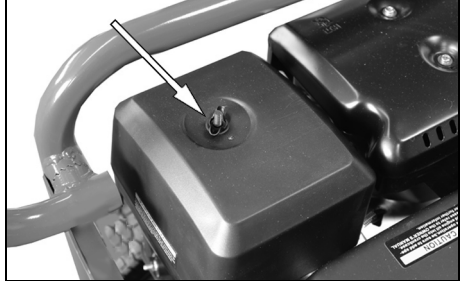

2. Remove the second wingnut shown.

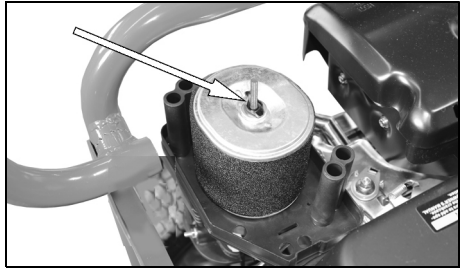

3. Remove the air filter element.

4. Make sure that the air filter is clean and not damaged.

- If the air filter is damaged contact CLARKE spare parts department for a replacement. If the filter is dirty, wash it in a solution of warm water and mild detergent and rinse thoroughly. Leave the filter to dry completely before immersing the filter in clean engine oil and squeeze the filter to remove excess oil.

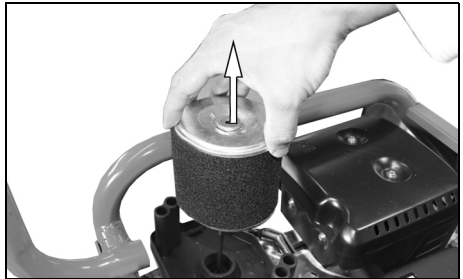

WARNING: DO NOT USE FLAMMABLE SOLVENTS OR PETROL TO CLEAN THE AIR FILTER.

5. Replace the filter and the air filter cover.

STORAGE

See the separate engine manual supplied, for information regarding the storage procedure.

1. Drain all water from the high pressure hose, coil it and store it on the gun/hose holder, located on the side of the power washer handle.
2. Drain all water from the spray gun and spray wand by holding the gun/wand vertically with the nozzle pointing down, and pulling the trigger. Store in the gun/hose holder.
3. Store all other parts so that they are protected from damage.

For long term storage, the petrol tank should be drained before the fuel deteriorates with time. Ensure that the engine is cold before draining the tank. Remove the fuel tank cap and use a pump type syphon to drain the petrol into an appropriate, clean container. DO NOT store petrol for long periods of time.

Dispose of excess petrol in an environmentally safe way, ideally by using elsewhere. Your local recycling centre can advise you on the best method of disposal. After the petrol tank has been drained, start the engine and allow it to use any petrol that may remain in the engine or fuel pipe. Make sure that the power washer has been thoroughly cleaned before storing it in a clean dry place.

TROUBLESHOOTING

If the following does not solve your problem please contact the CLARKE service department.

PROBLEM	CAUSE	SOLUTION
Engine will not start (see engine manual for further engine troubleshooting)	No fuel	Add fuel (see page 10)
	Low oil	Add oil (see page 9)
	Pressure builds up after two pulls on the recoil starter or after initial use	Squeeze the gun trigger to relieve the pressure
	Spark plug wire not attached correctly	Attach the spark plug wire
	Engine switch is in the OFF position	Set the engine switch to the ON position
	Choke lever is set to the choke position when the engine is warm	Set the choke lever to the NO CHOKE position
	Fuel valve closed	Open the fuel valve
Lack of pressure (initial use)	Water supply is not adequate	Make sure your water supply can deliver 5 gallons per minute at 20psi
	Leak in the high pressure hose fitting	Tighten the fitting, use sealant tape if required
	Nozzle is obstructed	Clear the nozzle
	Water filter screen is clogged	Remove and clean the filter
	Air in the supply hose	Turn off the engine Turn off the water supply Disconnect the water supply from the pump inlet and turn on the water to expel the air from the hose. When all the air has been removed, turn off the water supply and reconnect the hose. Turn on the water supply and pull the trigger to expel any air in the gun/wand

PROBLEM	CAUSE	SOLUTION
No or low pressure (initial use) continued	Choke lever is in the CHOKE position	Move the choke lever to the NO CHOKE position
	Throttle control lever is not in the fast position	Move the throttle control lever to the fast position
	High pressure hose is too long	Make sure the high pressure hose is under 100 feet
Will not draw chemicals	Chemical filter blocked	Clean the filter
	Chemicals being used are too thick	Dilute the chemicals. The chemicals should have the consistency of water
	High pressure hose is too long.	Use a longer supply hose instead of a longer high pressure hose
	Chemical build up inside the chemical injector	Have the parts cleaned or replaced by your dealer
No or low pressure (after a period of normal use)	Worn seal or packing	Have it replaced by your dealer
	Worn or obstructed valves	Have it replaced by your dealer
	Worn unloader piston	Have it replaced by your dealer
	Worn E-Z start valve	Have it replaced by your dealer
Water leaking at the gun / spray wand connection	Worn or broken O-ring	Check and replace
	Loose hose connection	Tighten
Water leaking at the pump	Loose connections	Tighten
	Piston packings worn	Have it replaced by your dealer
	Worn or broken O-ring	Have it replaced by your dealer
	Pump head or tubes damaged from freezing	Have it replaced by your dealer.
Oil leaking at the pump	Oil seals worn	Have it replaced by your dealer
	Loose drain plug	Tighten
	Worn O-rings	Check and replace
Pump pulsates	Nozzle obstructed	Clear the nozzle

SPECIFICATIONS

Model		PLS195B
Engine		
	Engine Model	G200F
	Power	5.5HP/4.1 kW (3600rpm)
	Engine type	Petrol /Air cooled
	Starting system	Recoil
	Fuel Capacity	3.6 L (max)
Water supply		
	Max. feed temperature	60°C
	Inlet pressure	3-6 bar
Performance Data		
	Working pressure	170 Bar
	Max. permissible pressure	182 Bar
	Max. water flow (l/min.)	12.5 (Mains supply) 12.2 (Barrel supply)
	Measured sound power level LWA dB	99
	Guaranteed sound power level LWA dB	101
	Vibration (measured at the lance)	<2.5m/s ²
	Uncertainty Factor	1.5
Dimensions		
	Handle opened	962 x 575 x 650 mm
	Handle closed	680 x 575 x 535 mm
	Weight (kg)	41.2

COMPONENT DIAGRAMS

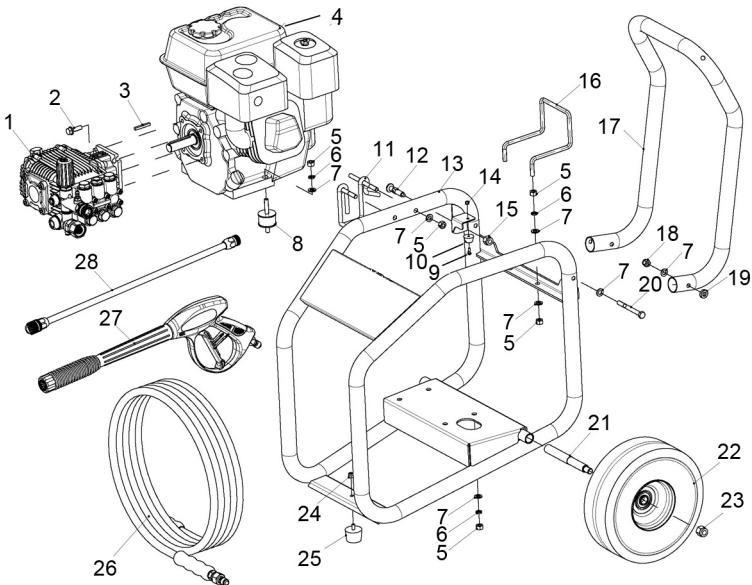
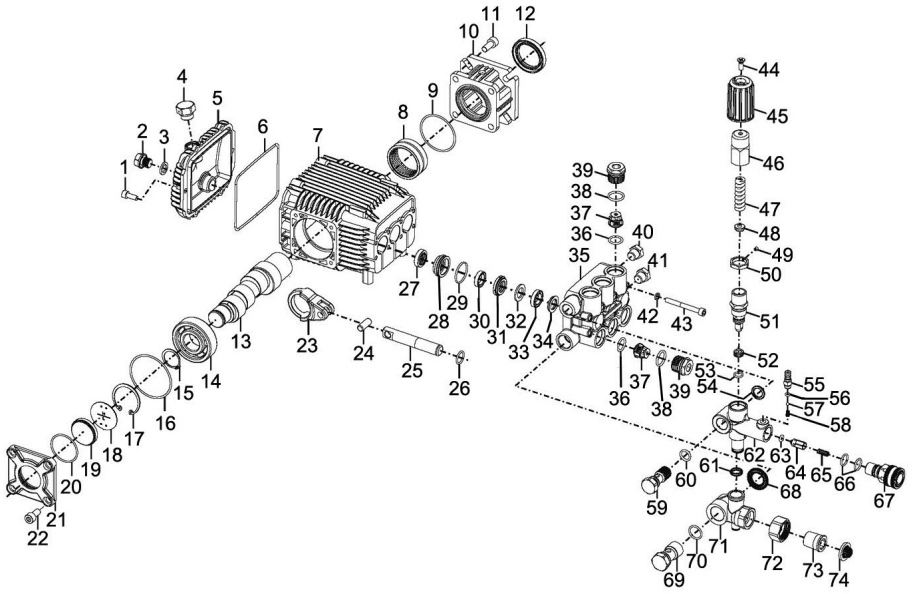

MECHANICAL PARTS LIST

1	Bolt M6x16
2	Oil Drain Plug
3	O-ring
4	Vented Oil Cap
5	Crankcase Cover
6	Gasket
7	Crankcase
8	Needle Bearing
9	O-ring
10	Flange
11	Bolt
12	Oil Seal
13	Crankshaft
14	Ball Bearing
15	Scrap ring
16	O-ring
17	Circlip
18	Oil Level Plate
19	Oil Sightglass
20	O-ring
21	Crankshaft cover
22	Bolt M8 x16
23	Connecting rod
24	Pin
25	Ceramic coated plunger
26	O-ring
27	Oil seal
28	Locating ring
29	Locating O-ring
30	Low pressure water seal
31	Compression ring
32	Compression Seal
33	High pressure water seal
34	Supporting ring
35	Manifold
36	O-ring (check valve)
37	Check valve

38	O-ring (valve cap)
39	Check valve cap
40	Manifold outlet plug
41	Thermal relief valve
42	Washer
43	Socket bolt M6x55
44	Screw
45	Regulator hand grip
46	Regulator adjusting knob
47	Spring
48	Spring seat
49	Screw, jam nut
50	Jam nut
51	Valve body
52	Valve seat
53	O-ring
54	Gasket
55	Detergent injector fitting
56	O-ring -injector fitting
57	Ball - injector fitting
58	Spring - injector fitting
59	Water outlet banjo bolt
60	O-ring
61	O-ring
62	Unloader valve housing
63	O-ring
64	Outlet checking valve
65	Spring - outlet checking valve
66	O-ring - outlet fitting
67	Quick disconnect outlet fitting
68	Gasket - bypass housing
69	Water inlet banjo bolt
70	O-ring - inlet banjo bolt
71	Bypass housing
72	Swivel nut - inlet connector
73	Body - inlet connector
74	Filter washer - inlet connector

FRAME AND ACCESSORY PARTS LIST

1	Pump assembly
2	Bolt
3	Key
4	Engine assembly
5	Nut
6	Spring washer
7	Plain washer
8	Rubber foot (engine)
9	Bolt
10	Rubber Pad
11	Lance support bracket
12	Pull Pin
13	Frame
14	Nut

15	Nut
16	Hose support bracket
17	Handle
18	Nut
19	Spring washer
20	Bolt
21	Axle
22	Wheel
23	Nut
24	Nut
25	Rubber foot - (frame)
26	High Pressure Hose
27	Gun
28	Lance

ENVIRONMENTAL PROTECTION



Recycle unwanted materials instead of disposing of them as waste. All unwanted accessories and packaging should be sorted and taken to a recycling centre for disposal in a manner which is compatible with the environment.

Through purchase of this product, the customer is taking on the obligation to deal with the WEEE in accordance with the WEEE regulations in relation to the treatment, recycling & recovery and environmentally sound disposal of the WEEE.

In effect, this means that this product must not be disposed of with general household waste. It must be disposed of according to the laws governing Waste Electrical and Electronic Equipment (WEEE) at a recognised disposal facility.

DECLARATION OF CONFORMITY



Hemmadi Street, Epping, Essex CM16 4UG

DECLARATION OF CONFORMITY

This is an important document and should be retained.

Product Description:

Petrol Power Washer

Model number(s):

PLS198B

Serial / batch Number:

N/A

Date of Issue:

23/10/2020

(Noise Conformity)

Notified Body:

N/A

Technical Documentation Holder:

A.R. Pond

Clarke International

2a Strubland Road

London E10 7RB

UK

Conformity Assessment Procedure:

to 2009/14/EC Annex V

Manufacturer:

Clarke International

Noise Related Value:

75dB l/h

Measured Sound Power Level:

89 dB

Guaranteed Sound Power Level:

101 dB

23-10-2020 PLS198B Petrol Pressure Washer D.O.C. EU5_No20-014
of 2

Page 1



Hemmadi Street, Epping, Essex CM16 4UG

DECLARATION OF CONFORMITY

This is an important document and should be retained.

We hereby declare that this product(s) complies with the following directive(s):

2014/30/EU Electromagnetic Compatibility Directive.

2006/42/EC Machinery Directive.

2000/14/EC Noise Emissions Directive. (amended by 2005/88/EC)

2016/1628 (EU) Emission of Gaseous Particulates Regulation. (with amendments).

The following standards have been applied to the product(s):

EN 60335-2-79:2012, EN 1679-1:1989+A1:2011, EN ISO 12100:2010, EN 55012:2007+A1:2009.

The technical documentation required to demonstrate that the product(s) meet(s) the requirement(s) of the aforementioned directive(s) has been compiled and is available for inspection by the relevant enforcement authorities.

The CE mark was first applied in: 2014

Signed:

J.A. Clarke
Director

23-10-2020 PLS198B Petrol Pressure Washer D.O.C. EU5_No20-014
of 2

Page 2

A SELECTION FROM THE VAST RANGE OF

Clarke®

QUALITY PRODUCTS



AIR COMPRESSORS

From DIY to industrial, Plus air tools, spray guns and accessories.

GENERATORS

Prime duty or emergency standby for business, home and leisure.

POWER WASHERS

Hot and cold, electric and engine driven - we have what you need

WELDERS

Mig, Arc, Tig and Spot. From DIY to auto/industrial.

METALWORKING

Drills, grinders and saws for DIY and professional use.

WOODWORKING

Saws, sanders, lathes, mortisers and dust extraction.

HYDRAULICS

Cranes, body repair kits, transmission jacks for all types of workshop use.

WATER PUMPS

Submersible, electric and engine driven for DIY, agriculture and industry.

POWER TOOLS

Angle grinders, cordless drill sets, saws and sanders.

STARTERS/CHARGERS

All sizes for car and commercial use.

PARTS & SERVICE:

0208 988 7400

Parts Enquiries

Parts@clarkeinternational.com

Servicing & Technical Enquiries

Service@clarkeinternational.com

SALES: UK 01992 565333 or Export 00 44 (0)1992 565335

Clarke INTERNATIONAL Hemnall Street, Epping, Essex CM16 4LG
www.clarkeinternational.com