

Performance according to ISO 9906:2012 – Grade 3B

Power data referred to:

Water, pure [100%]; 4°C; 1000kg/m³; 1.57mm²/s

Liquid temperature:

-10°C (14°F) to +110 °C (230°F) for heating pumps

-10°C (14°F) to +85 °C (185°F) for domestic hot water pumps



Pump data

Make	Lowara
Port to port (mm)	220
Electrical connection	Terminals
Specific EEI	<= 0,23
Nominal pressure	PN 6/10
Connection	Flanged / DN 32

Electrical data

Rated voltage	230 V
Frequency	50 / 60
Protection class	IP 44
Insulation class	F
Digital input	Contact load: 5V, 10 mA
Digital output	Vmax < 250 VAC / Imax < 2 A
Analog input	0-10 V / 4-20 mA
Leakage current	< 3.5 mA
Communication capabilities	Modbus RTU & BACnet MS/TP
Sound pressure level	<= 45 dB(A)
Rated current	1.4 A

Materials

Bush Bearing	Carbon, resin impregnated	Impeller	PPS
Thrust bearing	Aluminium	Wear Ring	Stainless steel
Bearing plate	Stainless steel	Rotor can	Stainless steel
Motor housing	Aluminum	Shaft	Stainless steel
O-rings	EPDM	Control box	Poly carbonate
PUMP HOUSING	Cast Iron		

Dimensions mm

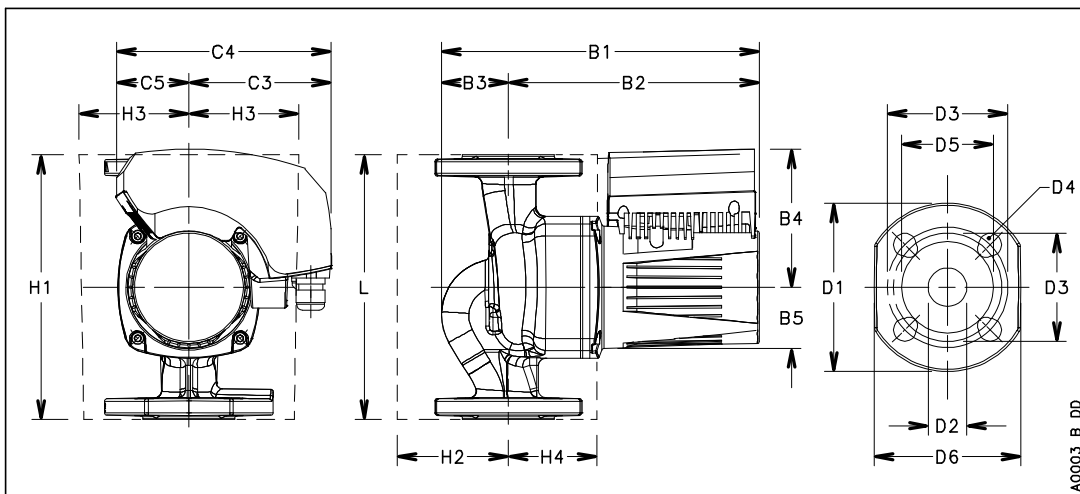

B1	266
B2	208
B3	58
B4	118
B5	51
C3	116
C4	178
C5	62
D1	140
D2	32
D3	90/100
D4	4 x 14/19
D5	76
G	DN 32
Gross Weight	13.3
H1	220
H2	94
H3	96
H4	76
L	220
Net Weight	9.8