

AQUABOOST

iMatic 450 Single Pump Booster Set

The Aquaboost iMatic range of booster sets features one or two submersible multistage pumps controlled by a dedicated variable speed frequency inverter.

The single pump 450 litre tank is fitted with a 0304 stainless steel pump, capable of delivering flow rates up to 6.0 m³/hour and capable of producing head pressures of up to 6.4 bar.



Features

- Flow rates up to 6.0 m³/h
- Head pressure up to 6.4 bar
- Single 304 stainless steel pump
- 450 litre plastic molded tank, constructed from WRAS approved material
- Dry run protection
- Stainless steel / brass discharge fittings
- Nickel plated WRAS approved ball valves
- Union fittings on controller
- WRAS approved 8 litre pressure vessel
- BMS volt free contacts

Application

- Cold water pressure and flow boosting in a range of domestic, commercial and industrial applications

Product Code Structure

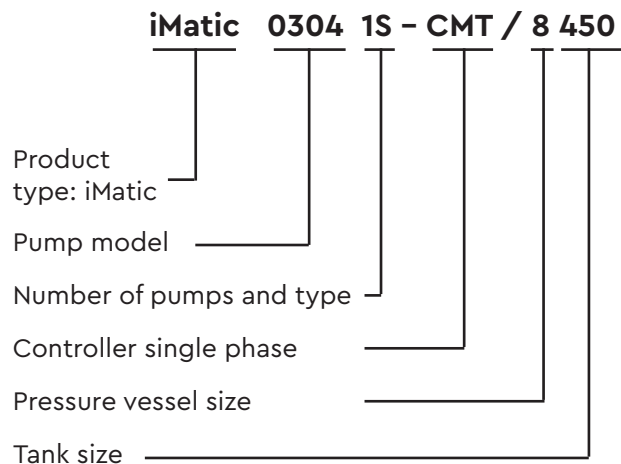

Performance Characteristics iMatic 0304 1S-CMT/8 450

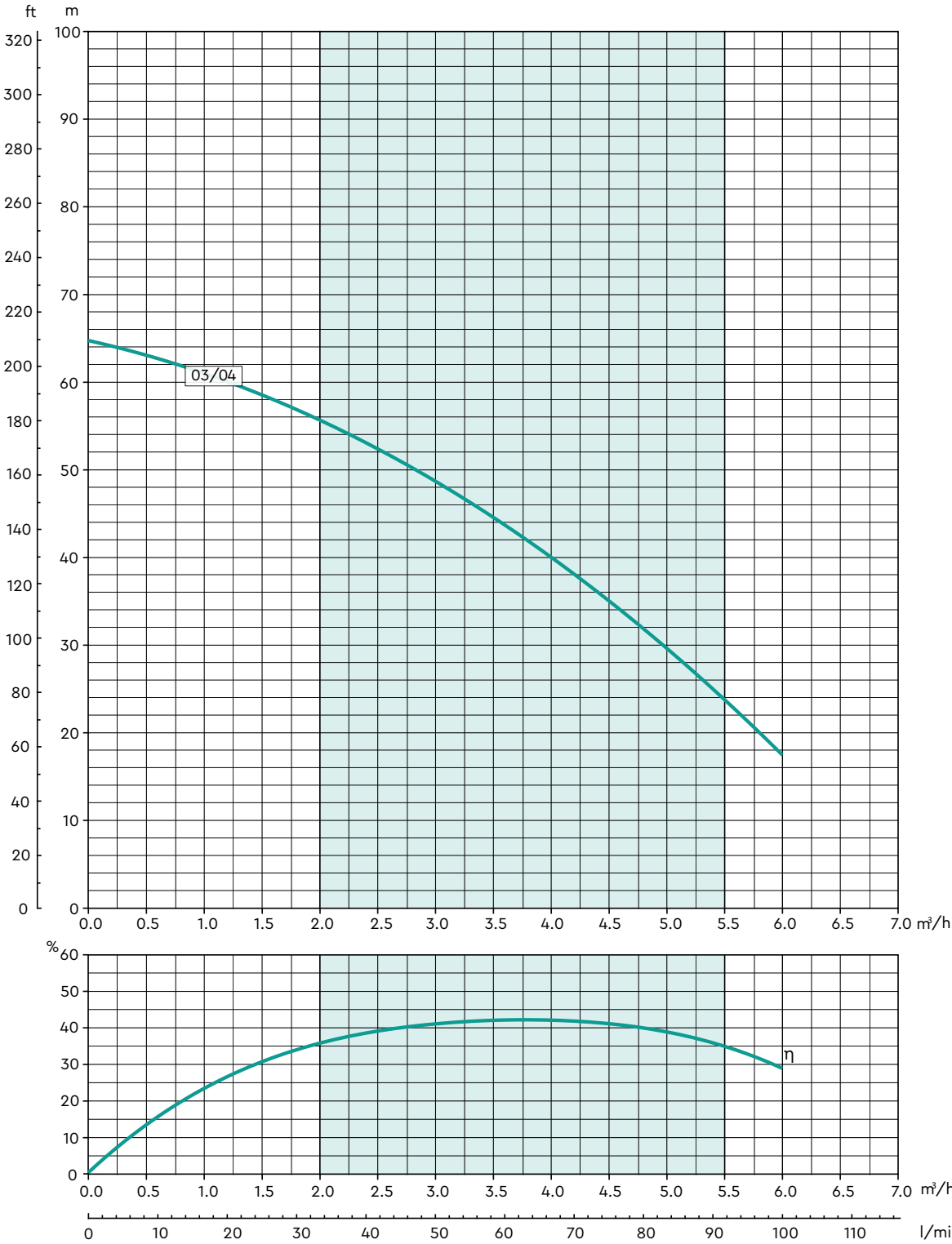

Technical Specification iMatic 0304 1S-CMT/8 450

		iMatic 0304 1S-CMT/8 450 47359	
General	Warranty	2 years	
	Approvals	CE	
	Typical noise	46 dB(A)	
Features	Water tank air gap	Type AF	
	Fluid category	CAT 3 / CAT 4	
	Pump control system	Variable speed	
	Pump control mode (single pump)	Duty	
	Dry run protection	✓	
	Pressure Vessel	8 litre / 10 bar	
	Pump check valve(s)	✓	
	Flexible connection hose – outlet	Optional Extra	
Performance	Nominal head	4.4 bar	
	Maximum head (closed valve)	6.4 bar	
	Nominal flow rate	3.5 m ³ /h	
	Maximum flow rate	6.0 m ³ /h	
	Ambient air temperature	0 – 40 °C	
Water tank	Nominal water tank size	450 litres	
	Usable water capacity	380 litres	
	Float valve	WRAS Approved	
	Water tank fill rate	30 l/min	
Connections	Inlet connection	½" BSP	
	Outlet connection (single pump)	1" BSP	
	Overflow	22mm	
Materials	Water tank	MDPE, food grade rated	
	Water tank base	MDPE, food grade rated	
Manifold	Manifold construction	N/A – Single Pump	
	Pump isolation valves	WRAS Approved Full bore, lever	
Pump	Pump type	Submersible multistage centrifugal	
	Motor type	Induction, thermal protection	
	Duty rating	Continuous	
Electrical	Power supply / phase / frequency	16 A 230 V.a.c./1/50 Hz	
	Full load current	6 Amps	
Dimensions	Depth	680 mm	
	Width	680 mm	
	Height	2245 mm	
Weight (dry/ filled)	Single pump	Dry	45 Kg
		Filled	425 Kg

Dimensions iMatic 0304 1S-CMT/8 450

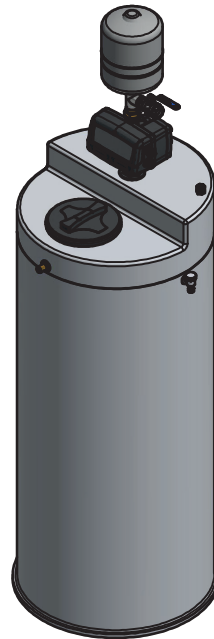
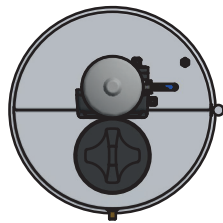
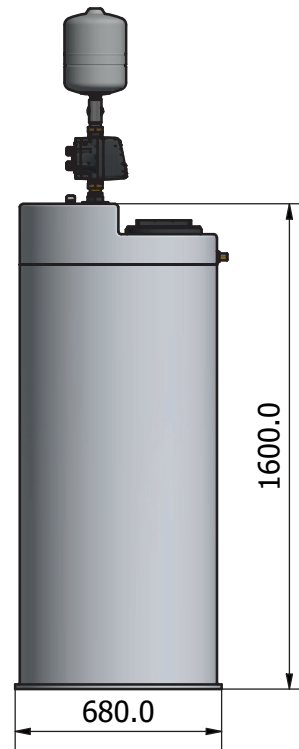
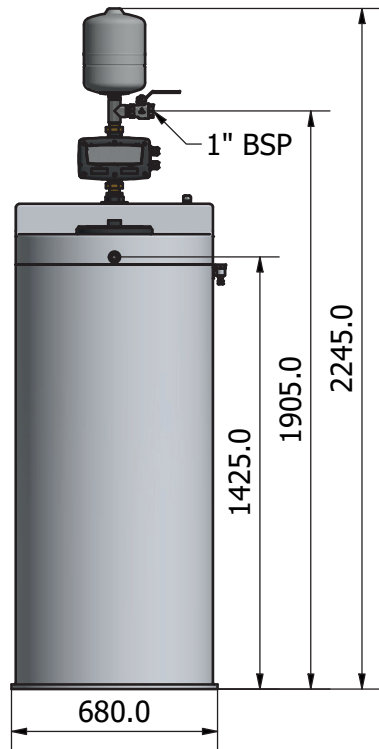

Scan QR Code for:

- Quick install information
- Operation & Maintenance manuals
- Wiring diagram
- Troubleshooting guides

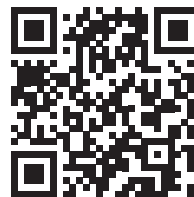

Stuart Turner Limited reserves the right to amend specifications without notice.

Stuart Turner Ltd, Market Place, Henley-on-Thames, Oxfordshire, RG9 2AD

Tel: +44 (0) 1491 572655

www.stuart-turner.co.uk

Pt. No. 21148 Issue 4420/01-01