

Count	Description
1	<p data-bbox="225 342 555 369">TPE3 40-120-S A-F-A-BQQE</p>  <p data-bbox="225 663 491 689">Product No.: 99272240</p> <p data-bbox="225 723 1406 797">Single-stage, close-coupled, volute pump with in-line suction and discharge ports of identical diameter. The pump is of the top-pull-out design, i.e. the power head (motor, pump head and impeller) can be removed for maintenance or service while the pump housing remains in the pipework.</p> <p data-bbox="225 808 1437 860">The shaft seal is according to EN 12756. Pipework connection is via PN 6/10 DIN flanges (EN 1092-2 and ISO 7005-2).</p> <p data-bbox="225 871 1433 922">The pump is fitted with a fan-cooled, permanent-magnet synchronous motor. The motor efficiency is classified as IE5 in accordance with IEC 60034-30-2.</p> <p data-bbox="225 934 1453 981">The motor includes a frequency converter and PI controller in the motor terminal box. This enables continuously variable control of the motor speed, which again enables adaptation of the performance to a given requirement.</p> <p data-bbox="225 1010 1118 1037">The pump is fitted with a combined temperature- and differential-pressure sensor.</p> <p data-bbox="225 1099 336 1126">Controls:</p> <p data-bbox="225 1133 667 1160">Frequency converter: Built-in</p> <p data-bbox="225 1189 312 1216">Liquid:</p> <p data-bbox="225 1223 655 1249">Pumped liquid: Water</p> <p data-bbox="225 1256 727 1283">Liquid temperature range: -13 .. 248 °F</p> <p data-bbox="225 1290 703 1317">Liquid temperature during operation: 68 °F</p> <p data-bbox="225 1323 703 1350">Density: 62.29 lb/ft³</p> <p data-bbox="225 1379 352 1406">Technical:</p> <p data-bbox="225 1413 826 1440">Pump speed on which pump data is based: 3390 rpm</p> <p data-bbox="225 1447 735 1473">Rated flow: 62.1 US gpm</p> <p data-bbox="225 1480 671 1507">Rated head: 23.62 ft</p> <p data-bbox="225 1514 655 1541">Actual impeller diameter: 2.91 in</p> <p data-bbox="225 1547 655 1574">Primary shaft seal: BQQE</p> <p data-bbox="225 1581 783 1608">Curve tolerance: ISO9906:2012 3B</p> <p data-bbox="225 1637 344 1664">Materials:</p> <p data-bbox="225 1671 903 1749">Pump housing: Cast iron EN-JL1040 ASTM A48-40 B</p> <p data-bbox="225 1756 903 1783">Impeller: Composite PES/PP 30% GF</p> <p data-bbox="225 1812 368 1839">Installation:</p> <p data-bbox="225 1845 711 1872">Range of ambient temperature: -4 .. 122 °F</p> <p data-bbox="225 1879 671 1906">Maximum operating pressure: 145 psi</p> <p data-bbox="225 1912 632 1939">Flange standard: DIN</p> <p data-bbox="225 1946 655 1973">Pipe connection: DN 40</p> <p data-bbox="225 1980 679 2007">Pressure stage: PN 6/10</p> <p data-bbox="225 2013 671 2040">Port-to-port length: 9 7/8 in</p> <p data-bbox="225 2047 632 2074">Flange size for motor: 56C</p> <p data-bbox="225 2103 400 2130">Electrical data:</p> <p data-bbox="225 2136 632 2163">Motor type: 71A</p>



Company name:

Created by:

Phone:

Date:

1/10/2019

Count	Description
	IE Efficiency class: IE5
	Rated power - P2: 0.5 HP
	Main frequency: 60 Hz
	Rated voltage: 1 x 200-240 V
	Rated current: 2.40-2.10 A
	Cos phi - power factor: 0.96
	Rated speed: 360-4000 rpm
	IE efficiency: 84.0%
	Motor efficiency at full load: 84.0 %
	Enclosure class (IEC 34-5): IP55
	Insulation class (IEC 85): F
	Others:
	Minimum efficiency index, MEI : 0.7
	ErP status: EuP Standalone/Prod.
	Net weight: 49.8 lb
	Gross weight: 65.7 lb
	Shipping volume: 3570 ft ³
	Danish VVS No.: 381601120
	Norwegian NRF no.: 9043456
	Country of origin: HU
	Custom tariff no.: 84137051

99272240 TPE3 40-120-S A-F-A-BQQE 60 Hz

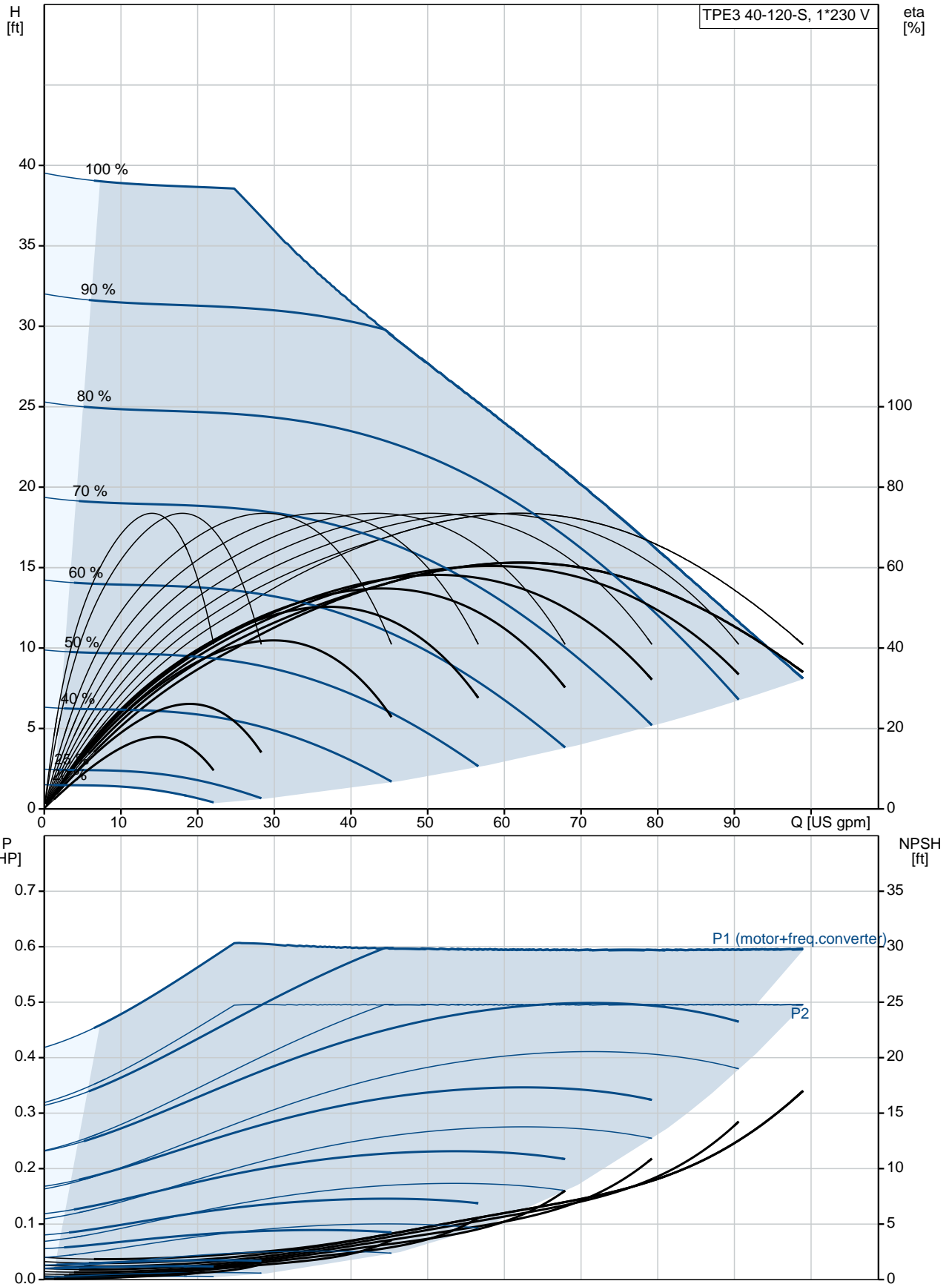

Description	Value
General information:	
Product name:	TPE3 40-120-S A-F-A-BQQE
Product No.:	99272240
EAN:	5713826360917
Technical:	
Pump speed on which pump data is based:	3390 rpm
Rated flow:	62.1 US gpm
Rated head:	23.62 ft
Head max:	39.37 ft
Actual impeller diameter:	2.91 in
Primary shaft seal:	BQQE
Curve tolerance:	ISO9906:2012 3B
Pump version:	A
Model:	A
Materials:	
Pump housing:	Cast iron
	EN-JL1040
	ASTM A48-40 B
Impeller:	Composite PES/PP 30% GF
Material code:	A
Installation:	
Range of ambient temperature:	-4 .. 122 °F
Maximum operating pressure:	145 psi
Flange standard:	DIN
Pipe connection:	DN 40
Pressure stage:	PN 6/10
Port-to-port length:	9 7/8 in
Flange size for motor:	56C
Connect code:	F
Liquid:	
Pumped liquid:	Water
Liquid temperature range:	-13 .. 248 °F
Liquid temperature during operation:	68 °F
Density:	62.29 lb/ft ³
Electrical data:	
Motor type:	71A
IE Efficiency class:	IE5
Rated power - P2:	0.5 HP
Main frequency:	60 Hz
Rated voltage:	1 x 200-240 V
Rated current:	2.40-2.10 A
Cos phi - power factor:	0.96
Rated speed:	360-4000 rpm
IE efficiency:	84.0%
Motor efficiency at full load:	84.0 %
Enclosure class (IEC 34-5):	IP55
Insulation class (IEC 85):	F
Motor protection:	YES
Motor Number:	99137984
Controls:	
Control panel:	HMI300 - Graphical
Function Module:	FM300 - Advanced
Frequency converter:	Built-in
Others:	
Minimum efficiency index, MEI :	0.7
ErP status:	EuP Standalone/Prod.

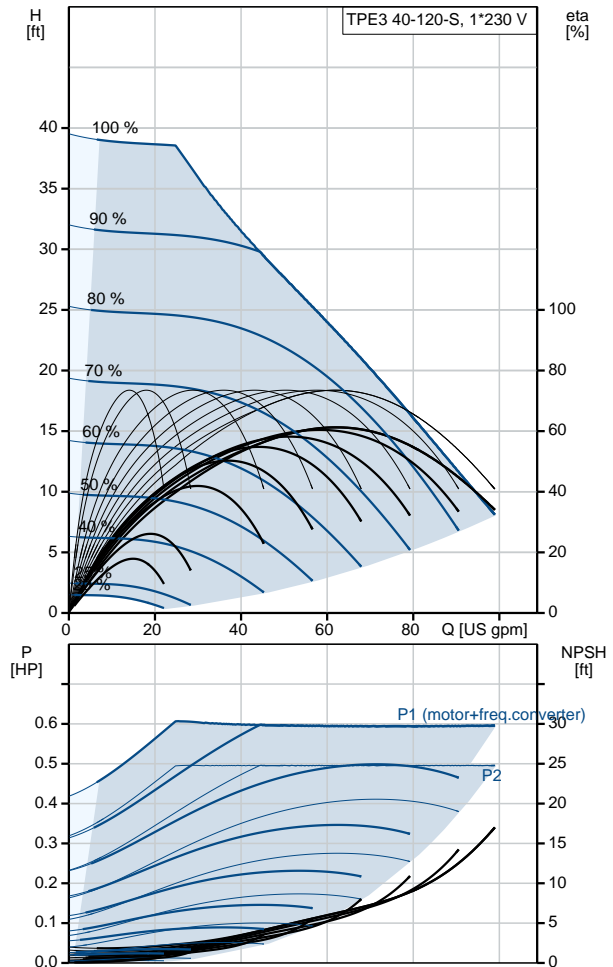



Company name:

Created by:

Phone:

Date:

1/10/2019

Description	Value
Net weight:	49.8 lb
Gross weight:	65.7 lb
Shipping volume:	3570 ft ³
Config. file no:	98481391
Danish VVS No.:	381601120
Norwegian NRF no.:	9043456
Country of origin:	HU
Custom tariff no.:	84137051

99272240 TPE3 40-120-S A-F-A-BQQE 60 Hz

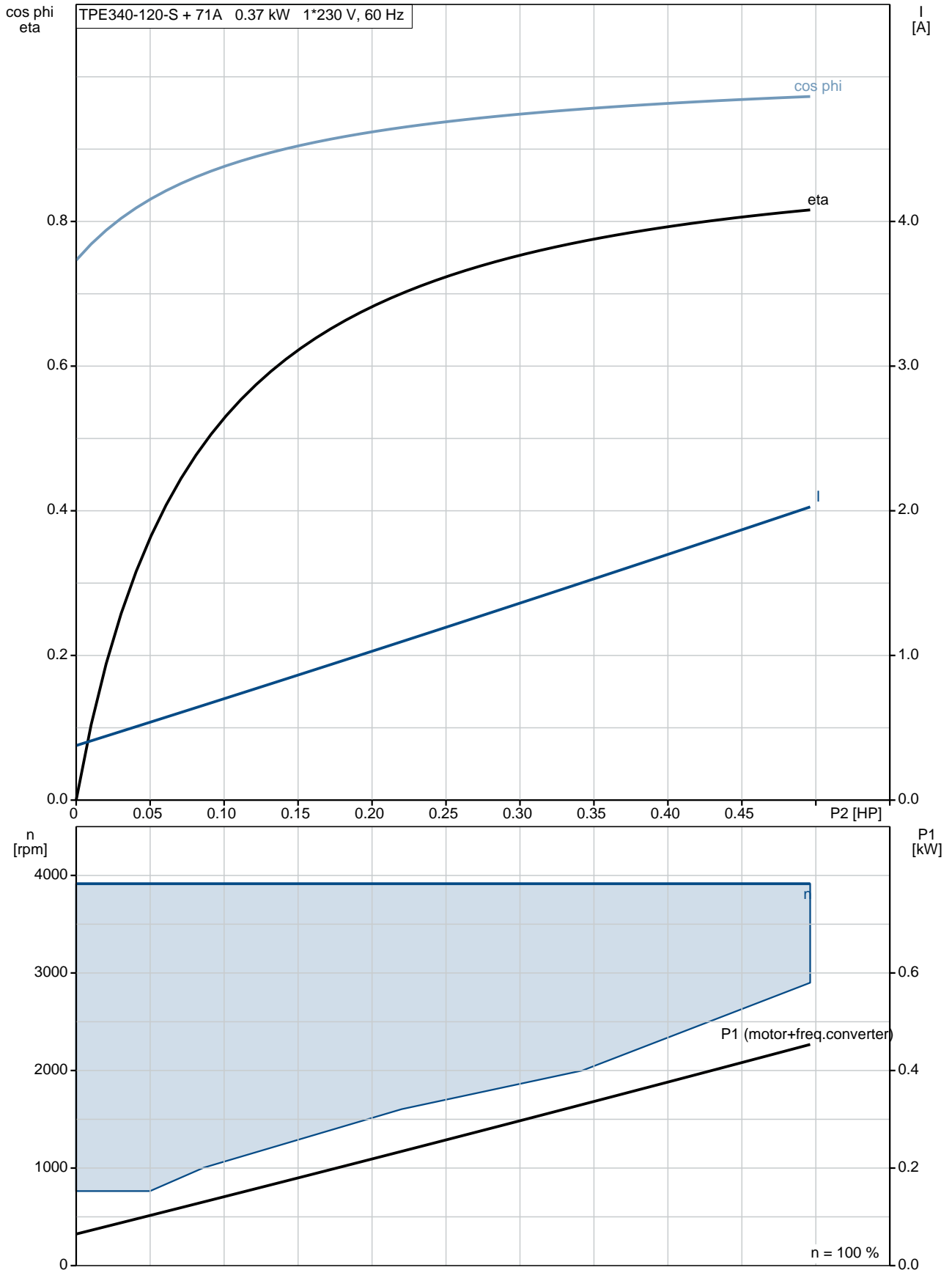

99272240 TPE3 40-120-S A-F-A-BQQE 60 Hz

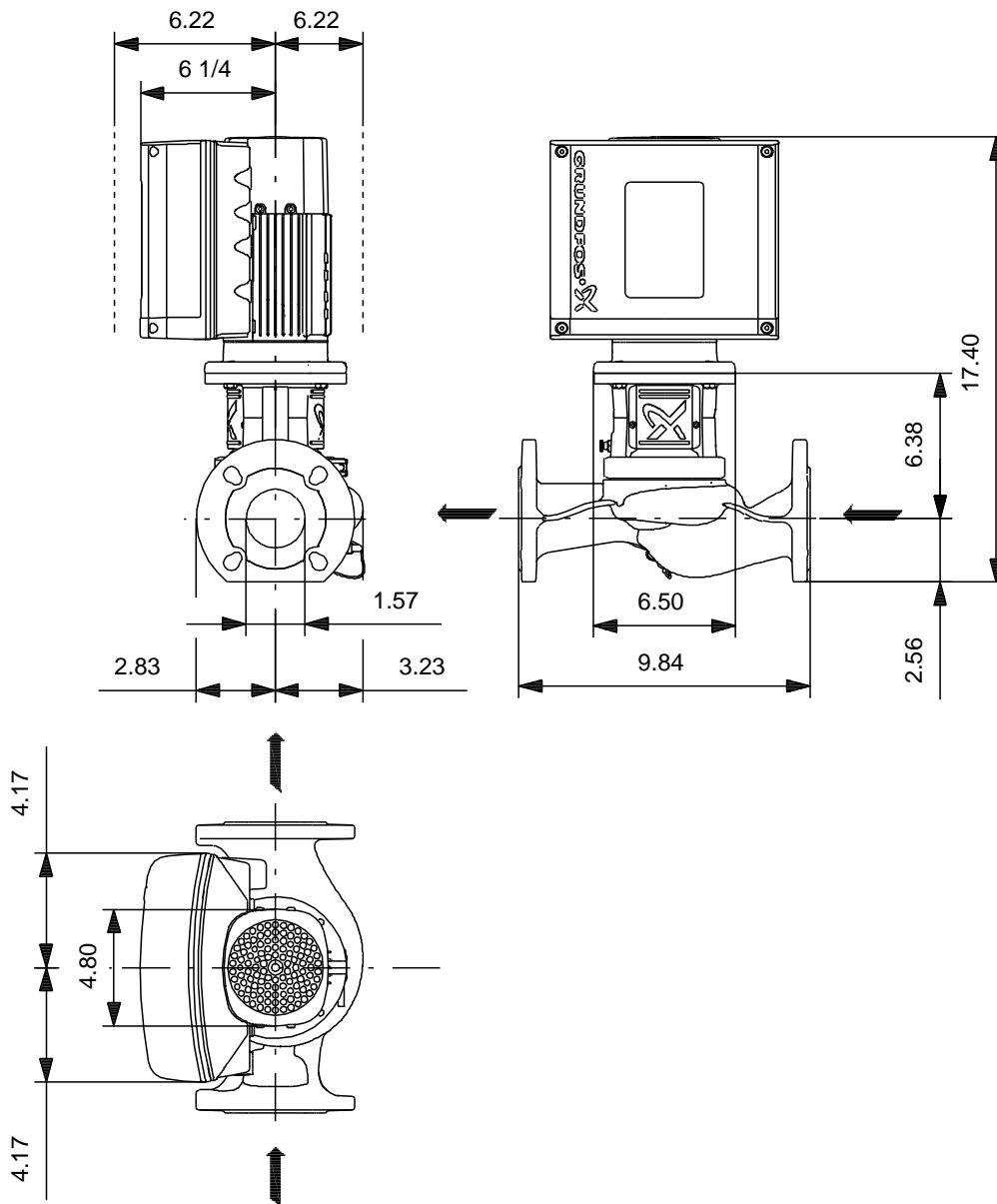

Note! All units are in [mm] unless otherwise stated.
Disclaimer: This simplified dimensional drawing does not show all details.

99272240 TPE3 40-120-S A-F-A-BQQE 60 Hz

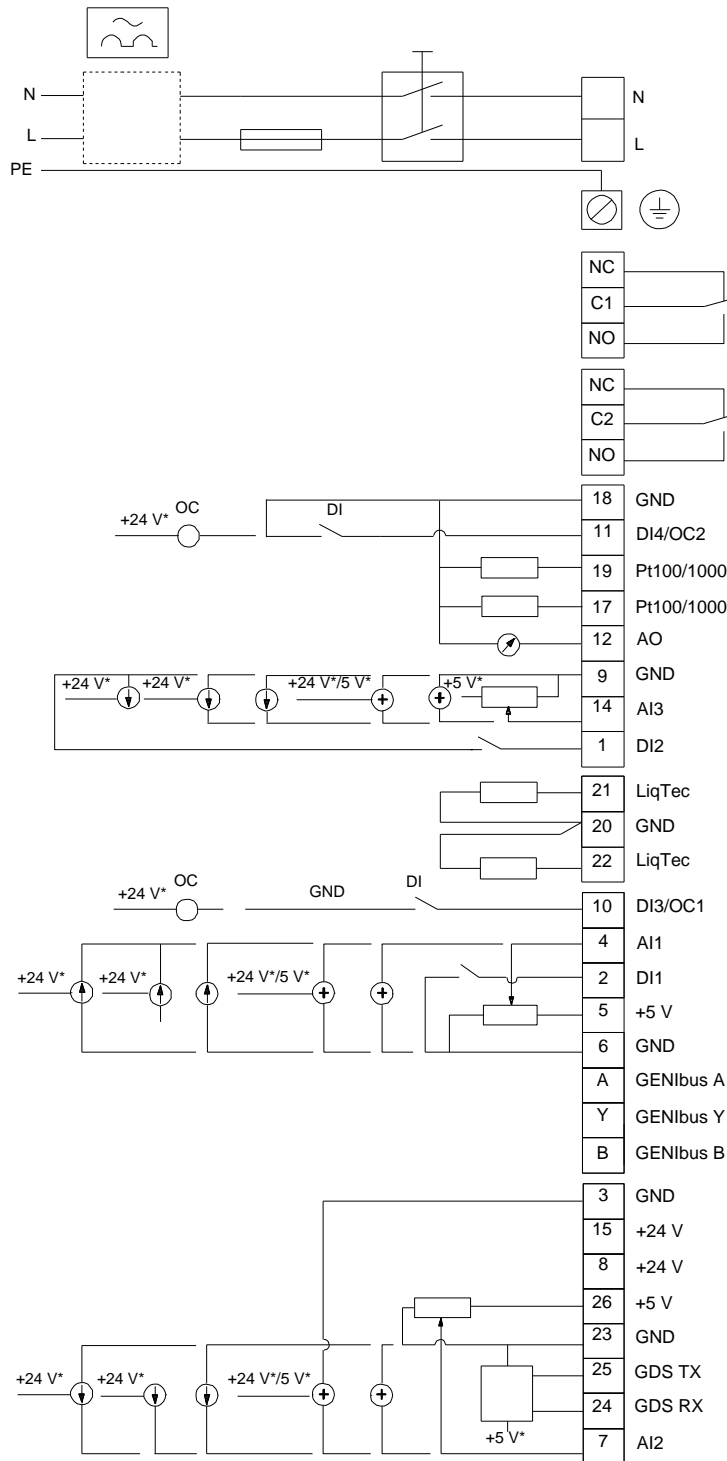

All units are [mm] unless otherwise presented.