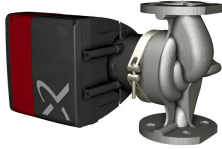

**Qty. Description**1 **MAGNA1 40-180 F N**Product No.: [99221327](#)

The new MAGNA1 is the simple option for a job well done. It is the perfect choice when replacing older circulators and due to its compliance with the EuP 2015 regulations, substantial savings on electricity is a reality. The ideal choice for basic performance needs in applications where basic system control and monitoring is desired.

- Monitoring via the fault relay, ensuring peace of mind
- Digital start/stop input available for remote pump control
- Continuous operation and reduced downtime with the wireless twin pump function (available on twin-head pumps)
- High energy efficiency resulting in substantial savings on electricity
- Easy setup and operation via the simple user interface
- No maintenance due to the canned-rotor type design.

MAGNA1 is the simple and efficient choice for most applications including

- Heating
  - Main pump
  - Mixing loops
  - Heating surfaces
- Cooling
  - Air conditioning surfaces
  - Ground source heat pump systems
  - Smaller chiller applications

**Liquid:**

Pumped liquid: Water  
Liquid temperature range: -10 .. 110 °C  
Liquid temperature during operation: 60 °C  
Density: 983.2 kg/m<sup>3</sup>

**Technical:**

TF class: 110  
Approvals on nameplate: CE,VDE,EAC,CN ROHS,WEEE

**Materials:**

Pump housing: Stainless steel  
EN 1.4308  
ASTM 351 CF8  
Impeller: PES 30%GF

**Installation:**

Range of ambient temperature: 0 .. 40 °C  
Maximum operating pressure: 10 bar  
Flange standard: DIN  
Pipe connection: DN 40  
Pressure rating: PN6/10  
Port-to-port length: 250 mm

Qty.	Description
------	-------------

**Electrical data:**

Power input - P1:	16.01 .. 615 W
Mains frequency:	50 Hz
Rated voltage:	1 x 230 V
Maximum current consumption:	0.22 .. 2.71 A
Enclosure class (IEC 34-5):	X4D
Insulation class (IEC 85):	F

**Others:**

Energy (EEI):	0.20
Net weight:	16.9 kg
Gross weight:	18.2 kg
Shipping volume:	0.039 m <sup>3</sup>
Country of origin:	DE
Custom tariff no.:	84137030

## 99221327 MAGNA1 40-180 F N 50 Hz

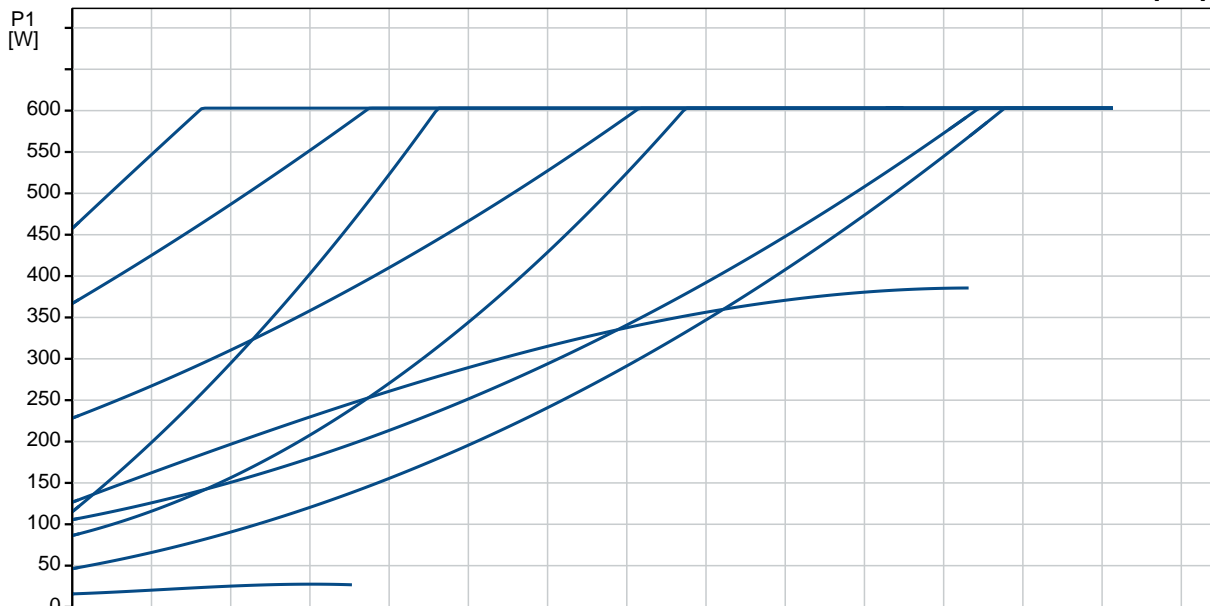
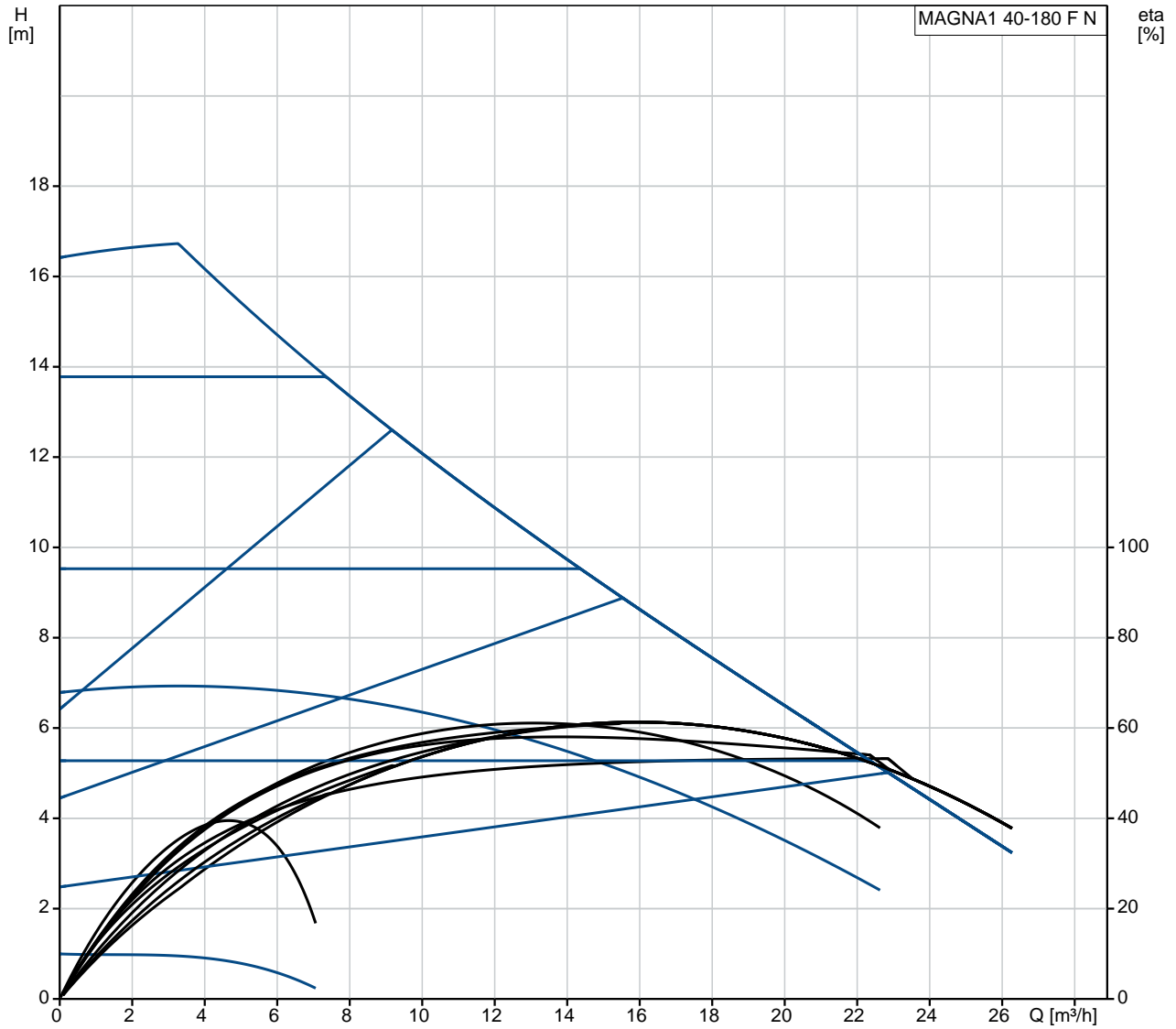

Description	Value
<b>General information:</b>	
Product name:	MAGNA1 40-180 F N
Product No:	99221327
EAN number:	5712608943003
Price:	2.718,00 GBP
<b>Technical:</b>	
Head max:	180 dm
TF class:	110
Approvals on nameplate:	CE,VDE,EAC,CN ROHS,WEEE
Model:	C
<b>Materials:</b>	
Pump housing:	Stainless steel EN 1.4308 ASTM 351 CF8
Impeller:	PES 30%GF
<b>Installation:</b>	
Range of ambient temperature:	0 .. 40 °C
Maximum operating pressure:	10 bar
Flange standard:	DIN
Pipe connection:	DN 40
Pressure rating:	PN6/10
Port-to-port length:	250 mm
<b>Liquid:</b>	
Pumped liquid:	Water
Liquid temperature range:	-10 .. 110 °C
Liquid temperature during operation:	60 °C
Density:	983.2 kg/m <sup>3</sup>
<b>Electrical data:</b>	
Power input - P1:	16.01 .. 615 W
Mains frequency:	50 Hz
Rated voltage:	1 x 230 V
Maximum current consumption:	0.22 .. 2.71 A
Enclosure class (IEC 34-5):	X4D
Insulation class (IEC 85):	F
<b>Others:</b>	
Energy (EEI):	0.20
Net weight:	16.9 kg
Gross weight:	18.2 kg
Shipping volume:	0.039 m <sup>3</sup>
Country of origin:	DE
Custom tariff no.:	84137030

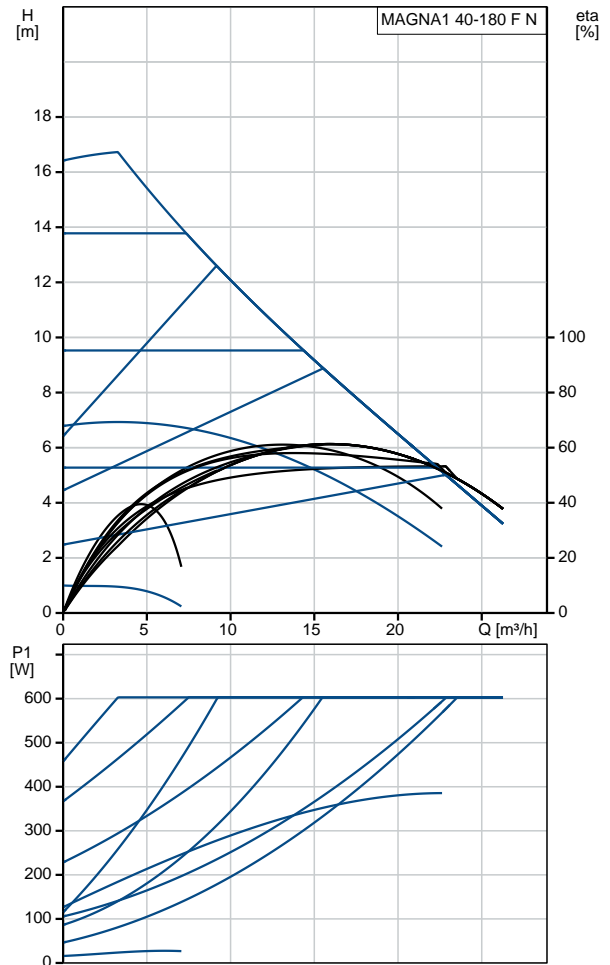

## 99221327 MAGNA1 40-180 F N 50 Hz

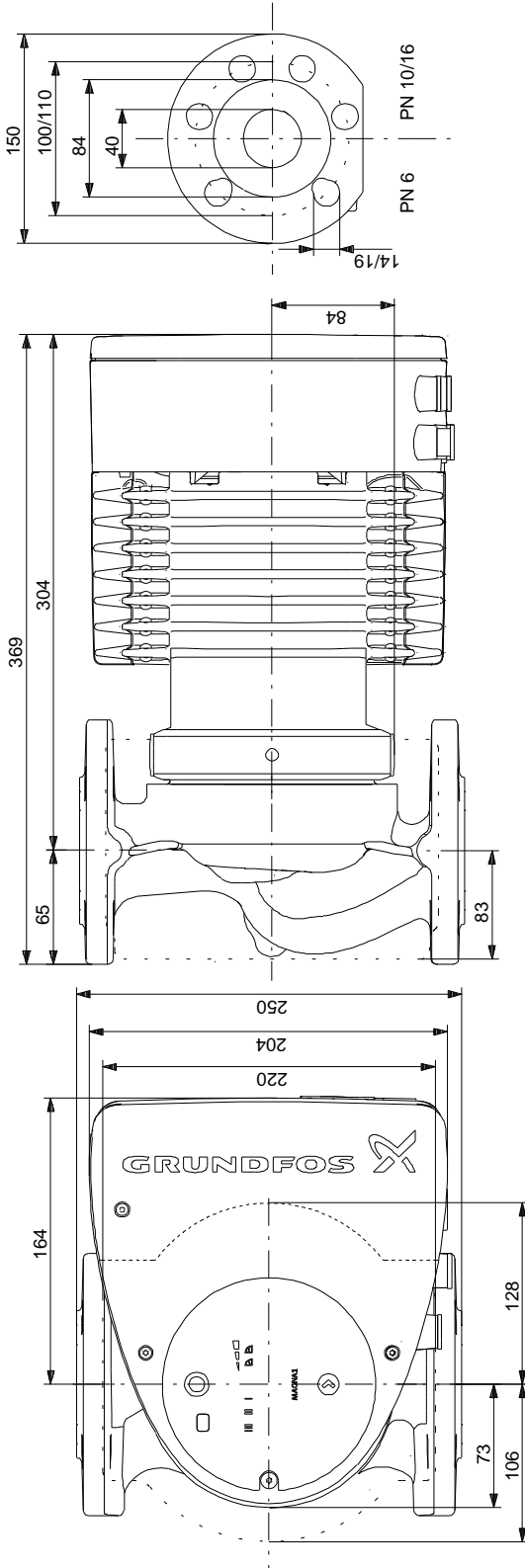

Note! All units are in [mm] unless others are stated.  
Disclaimer: This simplified dimensional drawing does not show all details.

## 99221327 MAGNA1 40-180 F N 50 Hz

Example of mains-connected motor with mains switch, backup fuse and additional protection

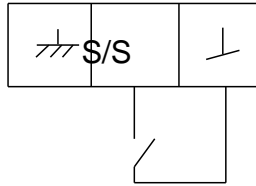
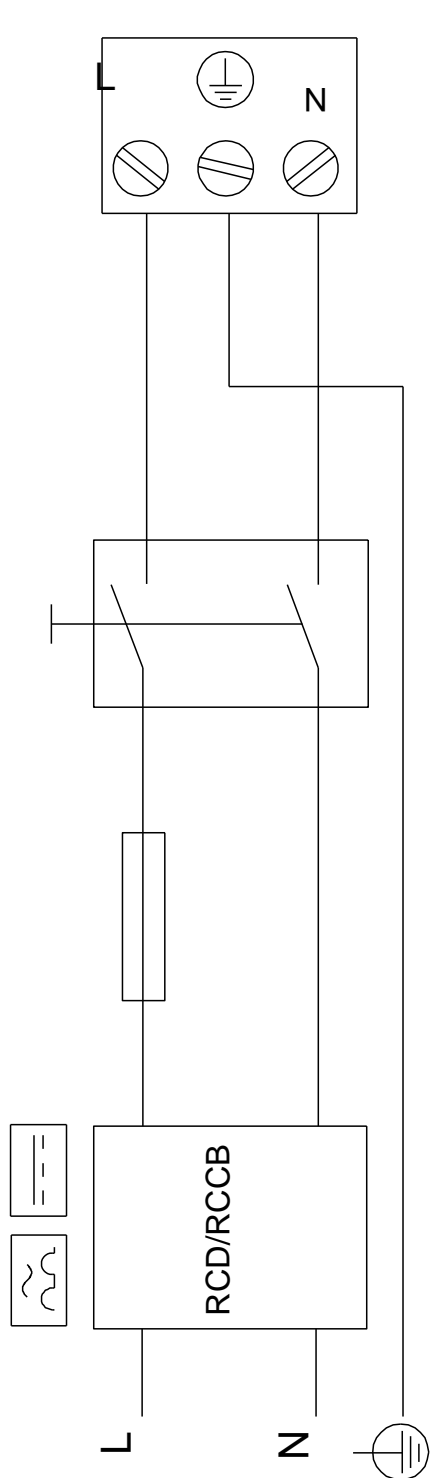

Digital inputs

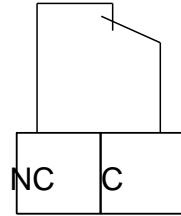

Relay outputs

Note! All units are in [mm] unless others are stated.