

**Qty. Description**

1 **MAGNA1 40-80 F**



Note! Product picture may differ from actual product

Product No.: [99221303](#)

The new MAGNA1 is the simple option for a job well done. It is the perfect choice when replacing older circulators and due to its compliance with the EuP 2015 regulations, substantial savings on electricity is a reality. The ideal choice for basic performance needs in applications where basic system control and monitoring is desired.

- Monitoring via the fault relay, ensuring peace of mind
- Digital start/stop input available for remote pump control
- Continuous operation and reduced downtime with the wireless twin pump function (available on twin-head pumps)
- High energy efficiency resulting in substantial savings on electricity
- Easy setup and operation via the simple user interface
- No maintenance due to the canned-rotor type design.

MAGNA1 is the simple and efficient choice for most applications including

- Heating
  - Main pump
  - Mixing loops
  - Heating surfaces
- Cooling
  - Air conditioning surfaces
  - Ground source heat pump systems
  - Smaller chiller applications

**Liquid:**

Pumped liquid: Water  
 Liquid temperature range: -10 .. 110 °C  
 Liquid temperature during operation: 60 °C  
 Density: 983.2 kg/m<sup>3</sup>

**Technical:**

TF class: 110  
 Approvals on nameplate: CE,VDE,EAC,CN ROHS,WEEE

**Materials:**

Pump housing: Cast iron  
 EN-GJL-250  
 ASTM A48-250B  
 Impeller: PES 30%GF

**Installation:**

Range of ambient temperature: 0 .. 40 °C  
 Maximum operating pressure: 10 bar  
 Flange standard: DIN  
 Pipe connection: DN 40  
 Pressure rating: PN6/10  
 Port-to-port length: 220 mm

Qty.	Description
------	-------------

**Electrical data:**

Power input - P1: 17.03 .. 267 W

Mains frequency: 50 Hz

Rated voltage: 1 x 230 V

Maximum current consumption: 0.19 .. 1.18 A

Enclosure class (IEC 34-5): X4D

Insulation class (IEC 85): F

**Others:**

Energy (EEI): 0.20

Net weight: 16.5 kg

Gross weight: 18.2 kg

Shipping volume: 0.039 m<sup>3</sup>

Finnish LVI No.: 4615188

## 99221303 MAGNA1 40-80 F 50 Hz

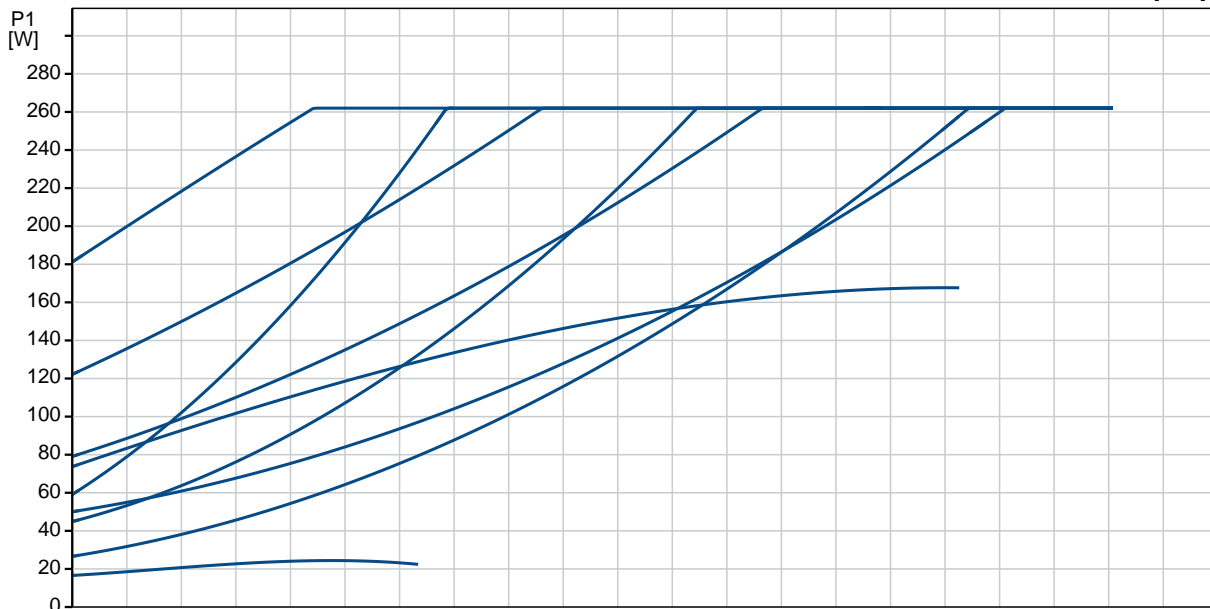
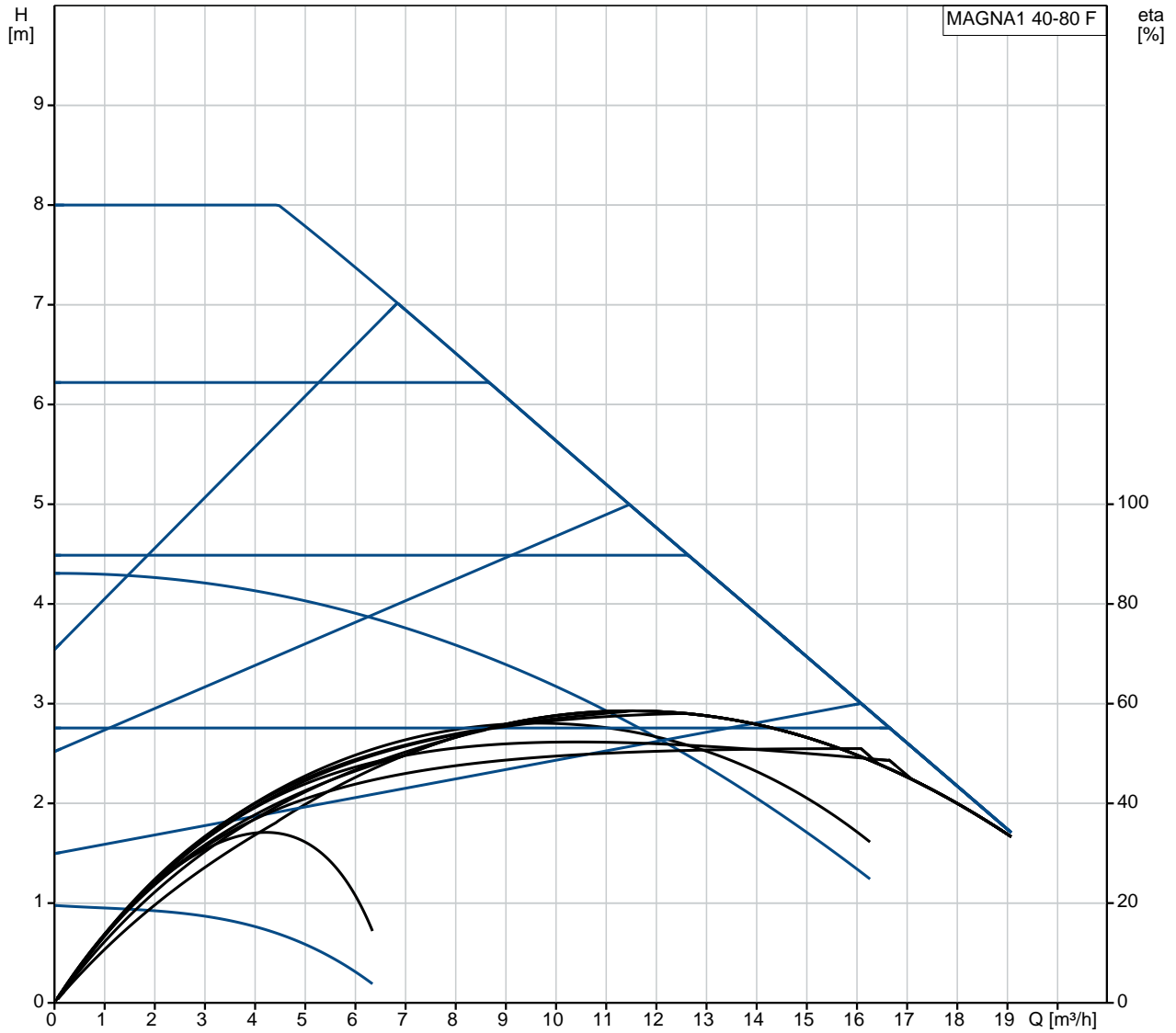

Description	Value
<b>General information:</b>	
Product name:	MAGNA1 40-80 F
Product No:	99221303
EAN number:	5712608942761
<b>Technical:</b>	
Head max:	80 dm
TF class:	110
Approvals on nameplate:	CE, VDE, EAC, CN ROHS, WEEE
Model:	C
<b>Materials:</b>	
Pump housing:	Cast iron EN-GJL-250 ASTM A48-250B
Impeller:	PES 30%GF
<b>Installation:</b>	
Range of ambient temperature:	0 .. 40 °C
Maximum operating pressure:	10 bar
Flange standard:	DIN
Pipe connection:	DN 40
Pressure rating:	PN6/10
Port-to-port length:	220 mm
<b>Liquid:</b>	
Pumped liquid:	Water
Liquid temperature range:	-10 .. 110 °C
Liquid temperature during operation:	60 °C
Density:	983.2 kg/m <sup>3</sup>
<b>Electrical data:</b>	
Power input - P1:	17.03 .. 267 W
Mains frequency:	50 Hz
Rated voltage:	1 x 230 V
Maximum current consumption:	0.19 .. 1.18 A
Enclosure class (IEC 34-5):	X4D
Insulation class (IEC 85):	F
<b>Others:</b>	
Energy (EEI):	0.20
Net weight:	16.5 kg
Gross weight:	18.2 kg
Shipping volume:	0.039 m <sup>3</sup>
Finnish LVI No.:	4615188

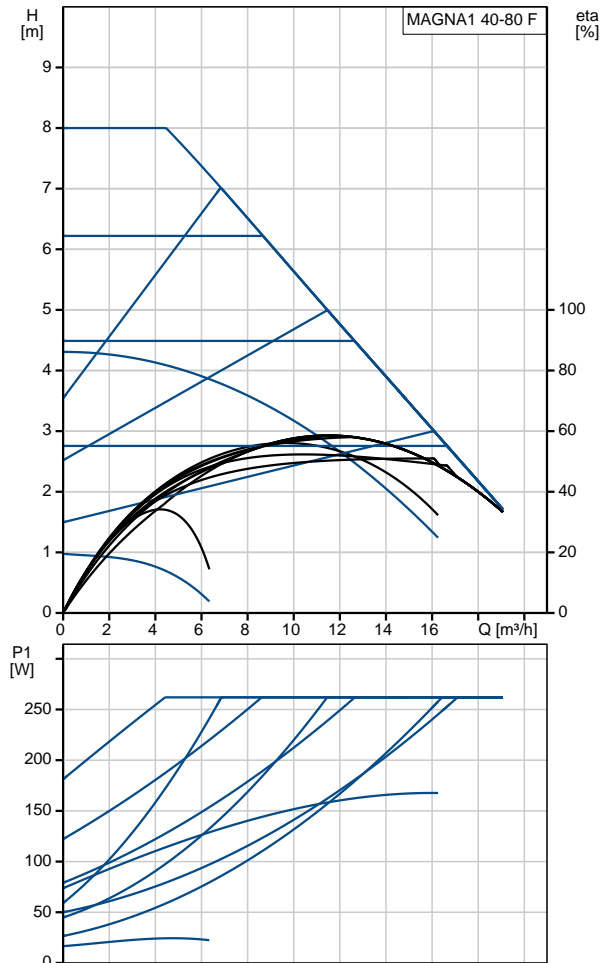

## 99221303 MAGNA1 40-80 F 50 Hz

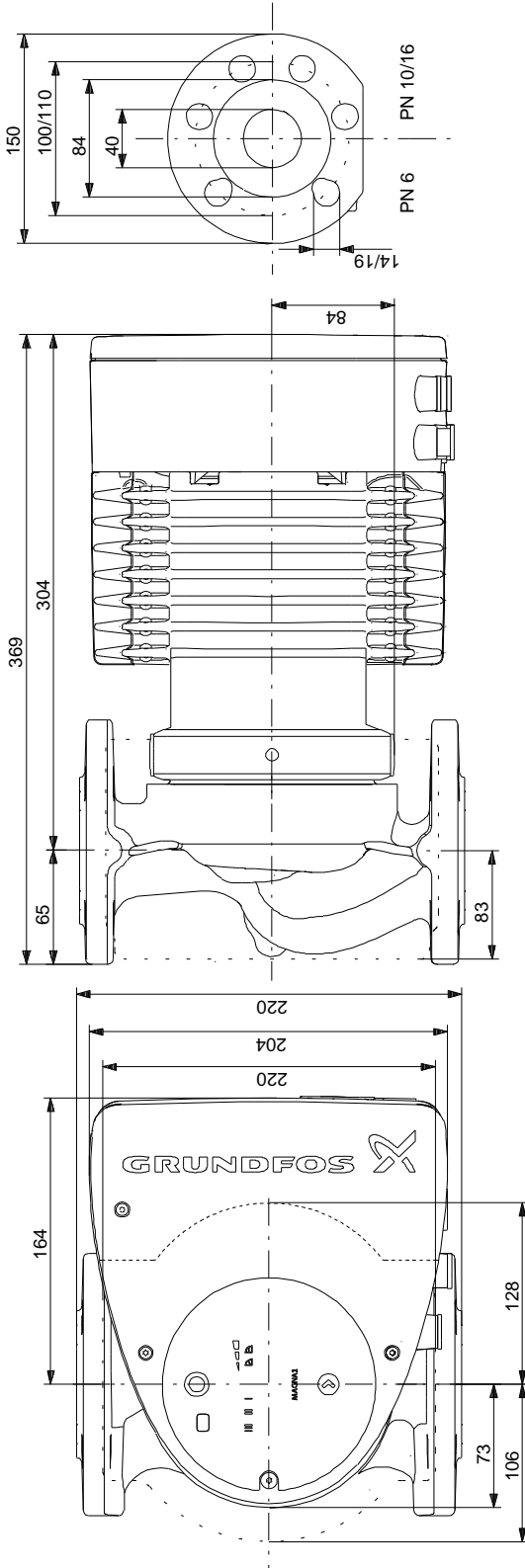

Note! All units are in [mm] unless others are stated.  
Disclaimer: This simplified dimensional drawing does not show all details.

## 99221303 MAGNA1 40-80 F 50 Hz

Example of mains-connected motor with mains switch, backup fuse and additional protection

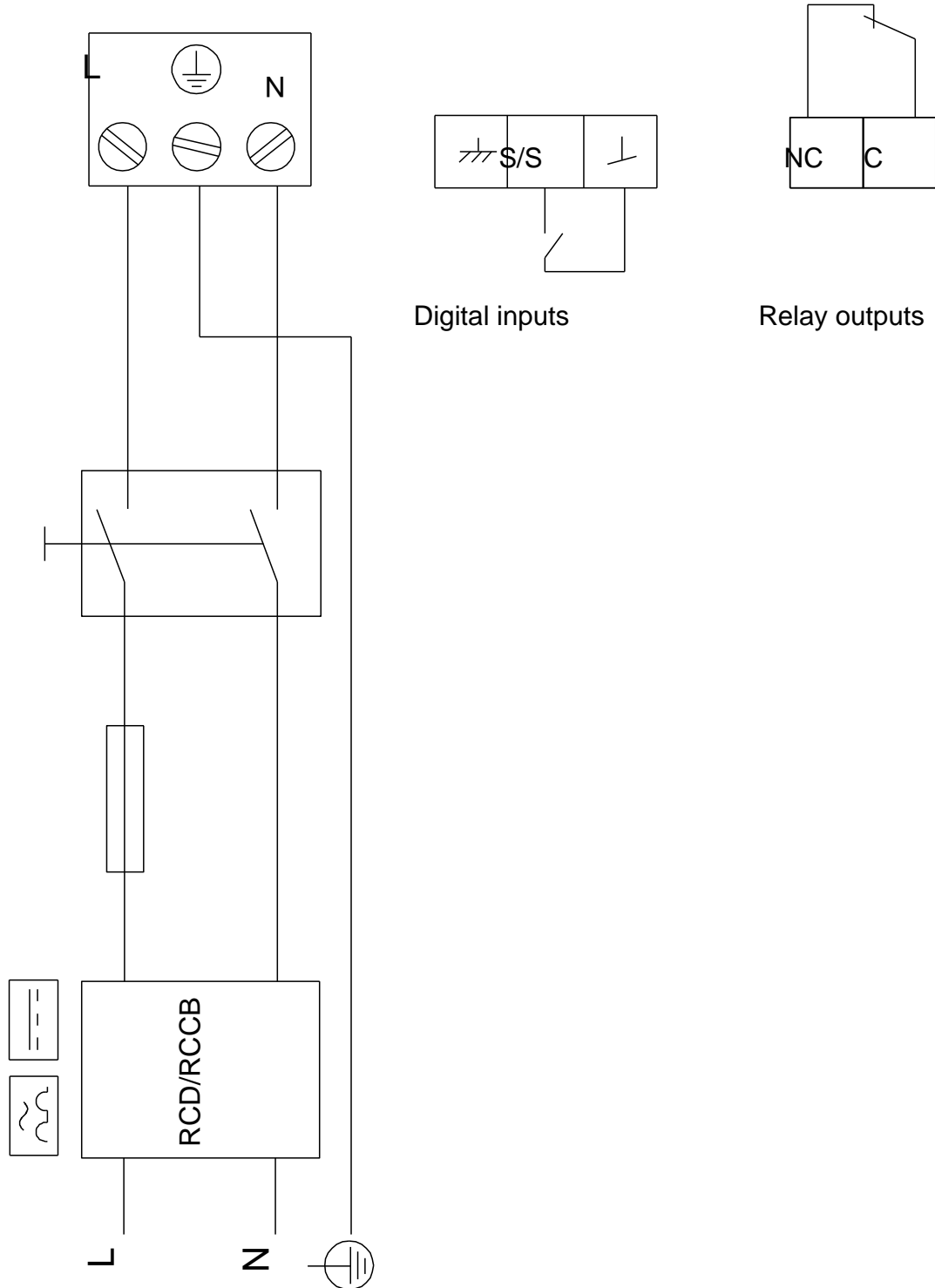

Note! All units are in [mm] unless others are stated.