

Position	Qty.	Description
	1	<p>MAGNA1 25-60</p>  <p>Product No.: 99221217</p> <p>The new MAGNA1 is the simple option for a job well done. It is the perfect choice when replacing older circulators and due to its compliance with the EuP 2015 regulations, substantial savings on electricity is a reality. The ideal choice for basic performance needs in applications where basic system control and monitoring is desired.</p> <ul style="list-style-type: none"> • Monitoring via the fault relay, ensuring peace of mind • Digital start/stop input available for remote pump control • Continuous operation and reduced downtime with the wireless twin pump function (available on twin-head pumps) • High energy efficiency resulting in substantial savings on electricity • Easy setup and operation via the simple user interface • No maintenance due to the canned-rotor type design. <p>MAGNA1 is the simple and efficient choice for most applications including</p> <ul style="list-style-type: none"> • Heating <ul style="list-style-type: none"> - Main pump - Mixing loops - Heating surfaces • Cooling <ul style="list-style-type: none"> - Air conditioning surfaces - Ground source heat pump systems - Smaller chiller applications <p>Liquid: Pumped liquid: Water Liquid temperature range: -10 .. 110 °C Liquid temperature during operation: 60 °C Density: 983.2 kg/m³</p> <p>Technical: TF class: 110 Approvals on nameplate: CE,VDE,EAC,CN ROHS,WEEE</p> <p>Materials: Pump housing: Cast iron EN-GJL-200 ASTM A48-200B Impeller: PES 30%GF</p> <p>Installation: Range of ambient temperature: 0 .. 40 °C Maximum operating pressure: 10 bar Pipe connection: G 1 1/2" Pressure rating: PN10 (@): 180 mm</p> <p>Electrical data:</p>



Company name:

Created by:

Phone:

Date:

31/10/2018

Position	Qty.	Description
		Power input - P1: 9 .. 92 W Mains frequency: 50 Hz Rated voltage: 1 x 230 V Maximum current consumption: 0.09 .. 0.74 A Enclosure class (IEC 34-5): X4D Insulation class (IEC 85): F Others: Energy (EEI): 0.20 Net weight: 4.38 kg Gross weight: 4.78 kg Shipping volume: 0.013 m ³ Finnish: LVI NO 4615250

99221217 MAGNA1 25-60 50 Hz

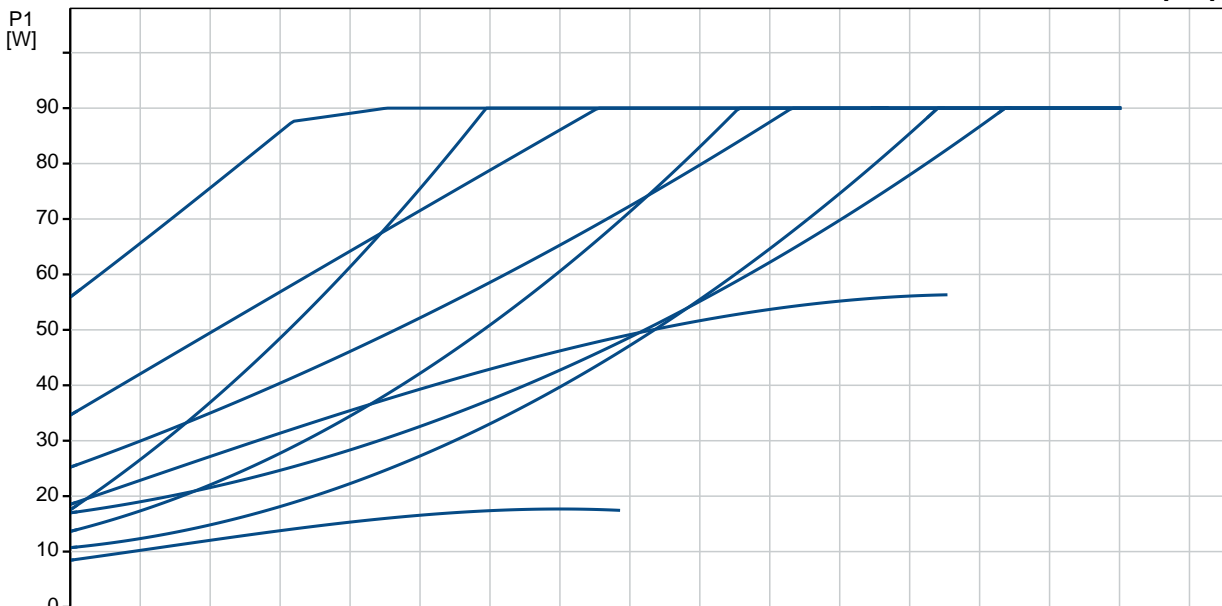
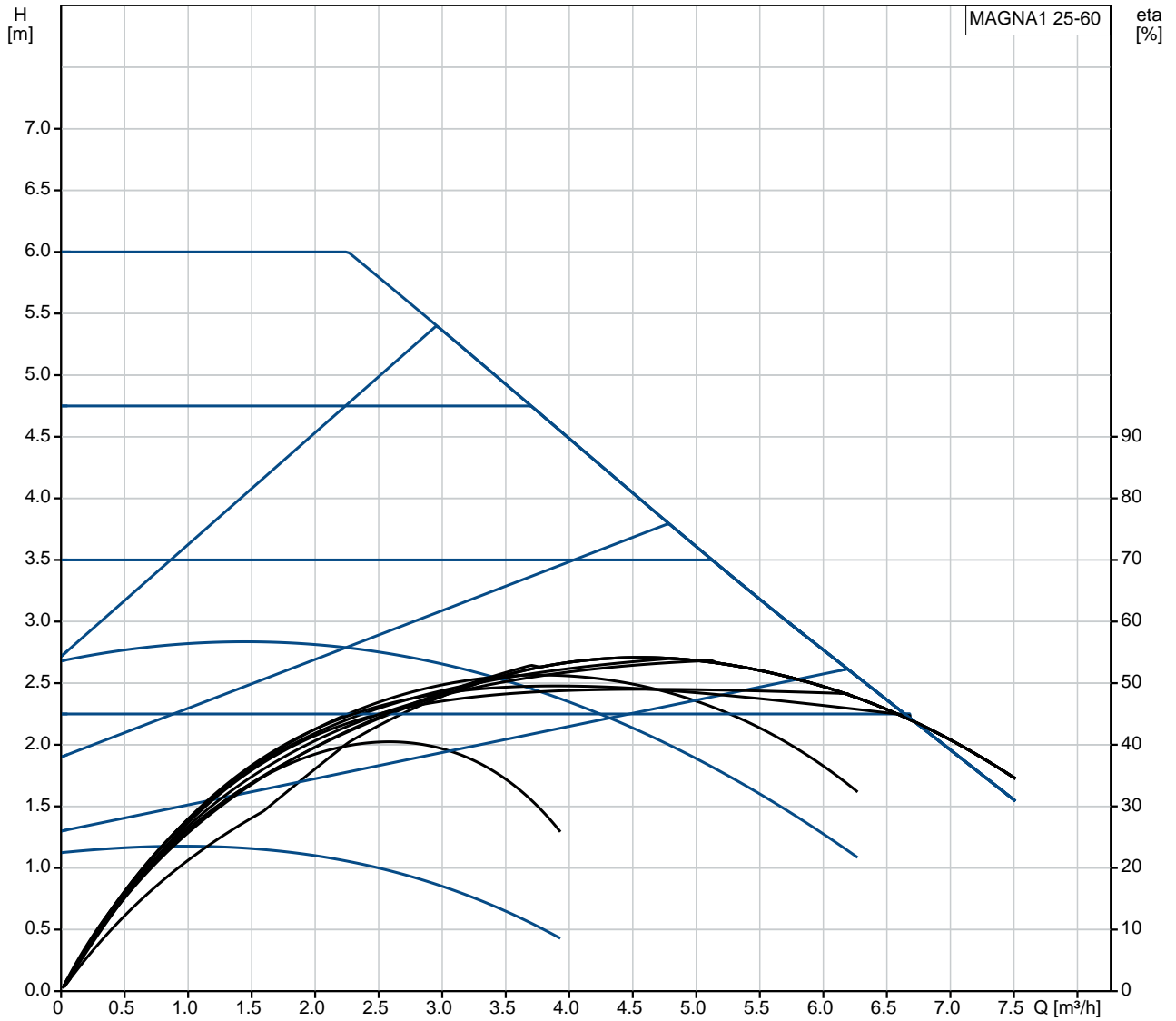

Description	Value
General information:	
Product name:	MAGNA1 25-60
Product No:	99221217
EAN number:	5712608941900
Technical:	
Head max:	60 dm
TF class:	110
Approvals on nameplate:	CE,VDE,EAC,CN ROHS,WEEE
Model:	C
Materials:	
Pump housing:	Cast iron EN-GJL-200 ASTM A48-200B
Impeller:	PES 30%GF
Installation:	
Range of ambient temperature:	0 .. 40 °C
Maximum operating pressure:	10 bar
Pipe connection:	G 1 1/2"
Pressure rating:	PN10
(@)	180 mm
Liquid:	
Pumped liquid:	Water
Liquid temperature range:	-10 .. 110 °C
Liquid temperature during operation:	60 °C
Density:	983.2 kg/m ³
Electrical data:	
Power input - P1:	9 .. 92 W
Mains frequency:	50 Hz
Rated voltage:	1 x 230 V
Maximum current consumption:	0.09 .. 0.74 A
Enclosure class (IEC 34-5):	X4D
Insulation class (IEC 85):	F
Others:	
Energy (EEI):	0.20
Net weight:	4.38 kg
Gross weight:	4.78 kg
Shipping volume:	0.013 m ³
Finnish:	LVI NO 4615250

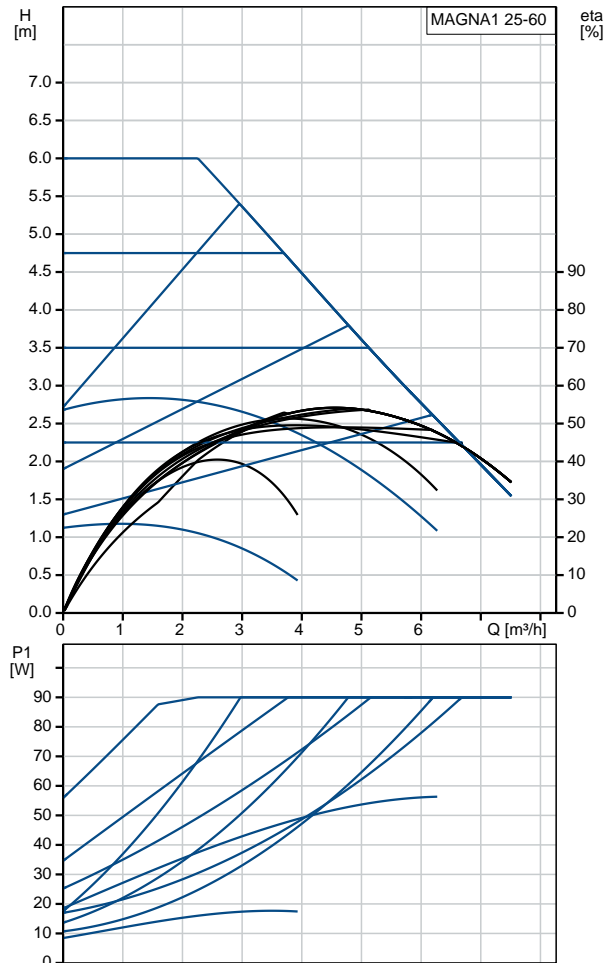

99221217 MAGNA1 25-60 50 Hz

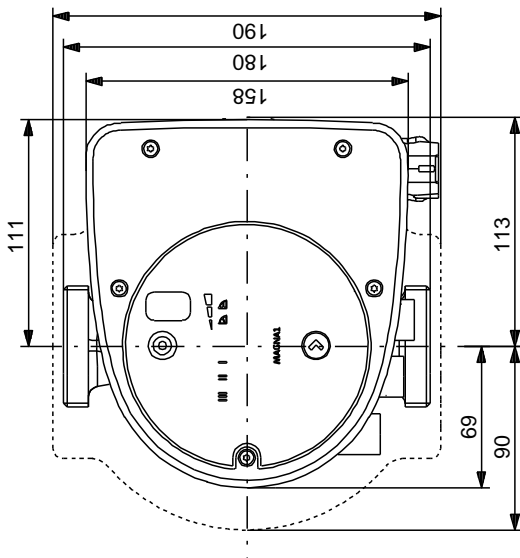
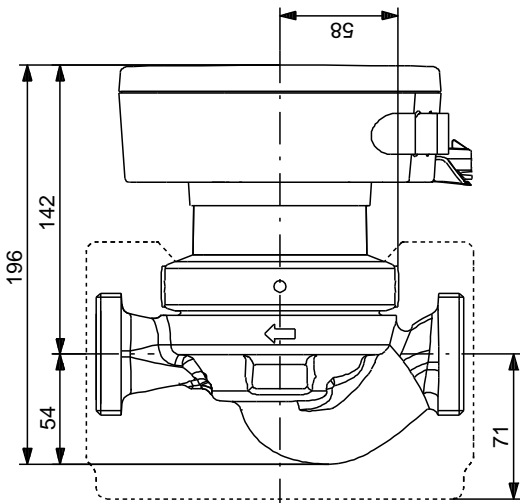
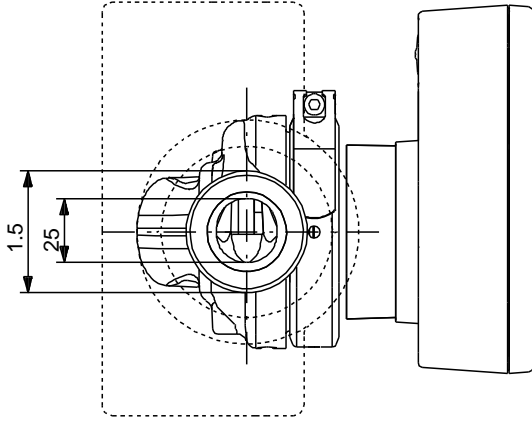

Note! All units are in [mm] unless others are stated.
Disclaimer: This simplified dimensional drawing does not show all details.

99221217 MAGNA1 25-60 50 Hz

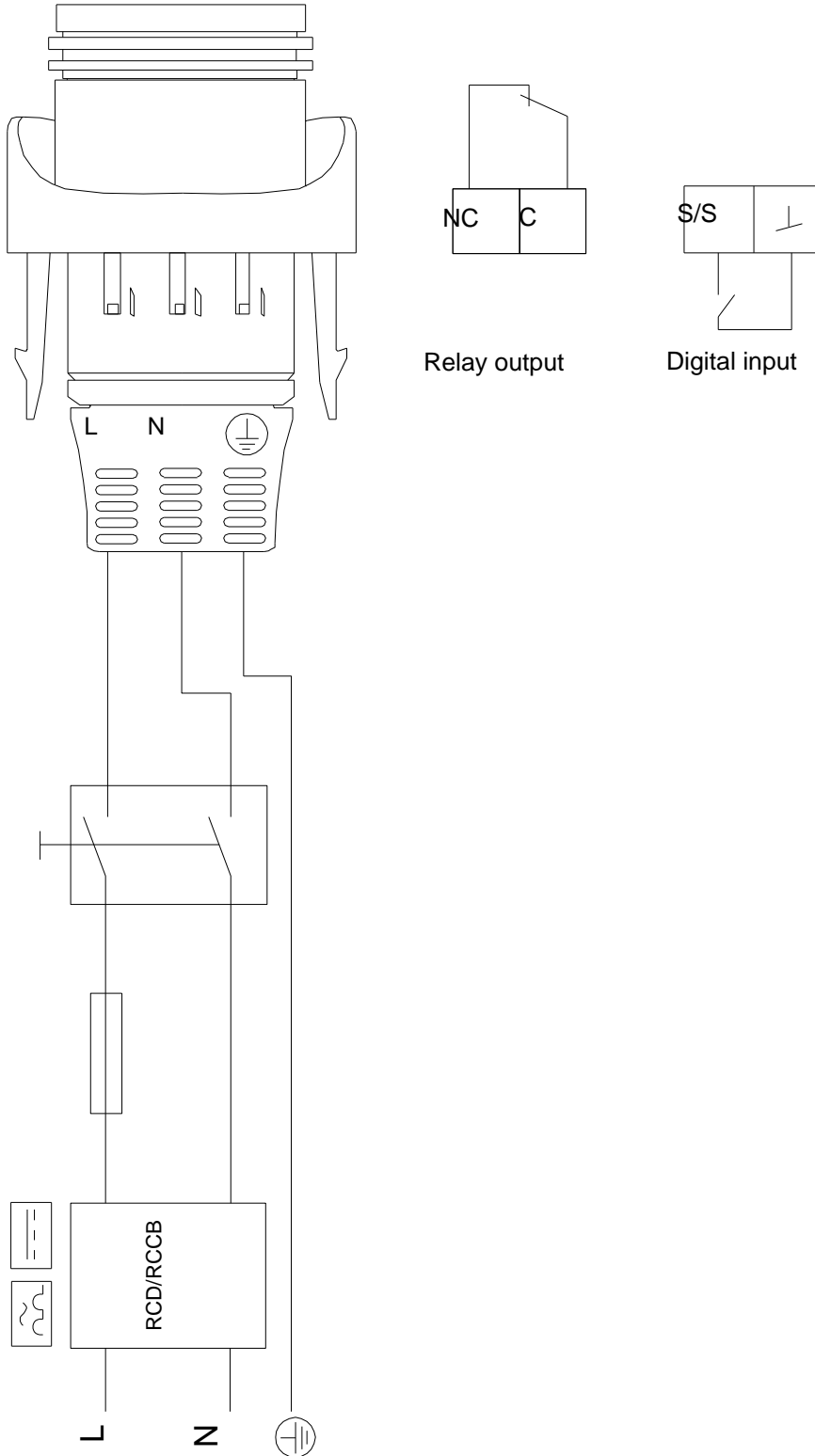

Note! All units are in [mm] unless others are stated.