

Qty. Description

1 CRIE 20-6 N-FGJ-A-E-HQQE



Note! Product picture may differ from actual product

Product No.: [99071698](#)

Vertical, multistage centrifugal pump with inlet and outlet ports on same the level (inline). Pump materials in contact with the liquid are in stainless steel. A cartridge shaft seal ensures high reliability, safe handling, and easy access and service. Power transmission is via a rigid split coupling. Pipe connection is via combined DIN-ANSI-JIS flanges.

The pump is fitted with a 3-phase, fan-cooled, permanent-magnet, synchronous motor.

The motor efficiency is classified as IE5 in accordance with IEC 60034-30-2.

The motor includes a frequency converter and PI controller in the motor terminal box. This enables continuously variable control of the motor speed, which again enables adaptation of the performance to a given requirement. An operating panel on the motor terminal box enables setting of required setpoint as well as setting of pump to "Min." or "Max." operation or to "Stop". The Grundfos Eye indicator on the operating panel provides visual indication of pump status:

- "Power on": Motor is running (rotating green indicator lights) or not running (permanently green indicator lights)
- "Warning": Motor is still running (rotating yellow indicator lights) or has stopped (permanently yellow indicator lights)
- "Alarm": Motor has stopped (flashing red indicator lights).

Communication with the pump is possible by means of Grundfos GO Remote (accessory). The remote control enables further settings as well as reading out of a number of parameters such as "Actual value", "Speed", "Power input" and total "Power consumption".

Controls:

Frequency converter: Built-in

Pressure sensor: Y

Liquid:

Pumped liquid: Water

Liquid temperature range: -20 .. 120 °C

Liquid temperature during operation: 20 °C

Density: 998.2 kg/m³

Technical:

Pump speed on which pump data are based: 3529 rpm

Rated flow: 25.3 m³/h

Rated head: 101.9 m

Pump orientation: Vertical

Qty.	Description
	<p>Shaft seal arrangement: Single Code for shaft seal: HQQE Approvals on nameplate: CE, EAC, ACS Curve tolerance: ISO9906:2012 3B</p> <p>Materials: Base: Stainless steel EN 1.4408 AISI 316 Impeller: Stainless steel EN 1.4301 AISI 304 Bearing: SIC</p> <p>Installation: Maximum ambient temperature: 50 °C Maximum operating pressure: 16 bar Max pressure at stated temp: 16 bar / 120 °C 16 bar / -20 °C Type of connection: DIN / ANSI / JIS Size of inlet connection: DN 50 2 inch Size of outlet connection: DN 50 2 inch Pressure rating for pipe connection: PN 25 Flange rating inlet: 300 lb Flange size for motor: FF300</p> <p>Electrical data: Motor standard: IEC Motor type: 160MH IE Efficiency class: IE5 Rated power - P2: 11 kW Power (P2) required by pump: 11 kW Mains frequency: 50 Hz Rated voltage: 3 x 380-500 V Rated current: 20.3-16.0 A Cos phi - power factor: 0.93-0.90 Rated speed: 360-4000 rpm Efficiency: 93.1% Motor efficiency at full load: 93.1 % Enclosure class (IEC 34-5): IP55 Insulation class (IEC 85): F</p> <p>Others: Minimum efficiency index, MEI η_{min}: 0.70 Net weight: 116 kg Gross weight: 147 kg Shipping volume: 0.619 m³ Country of origin: GB Custom tariff no.: 84137075</p>

99071698 CRIE 20-6 N-FGJ-A-E-HQQE 50 Hz

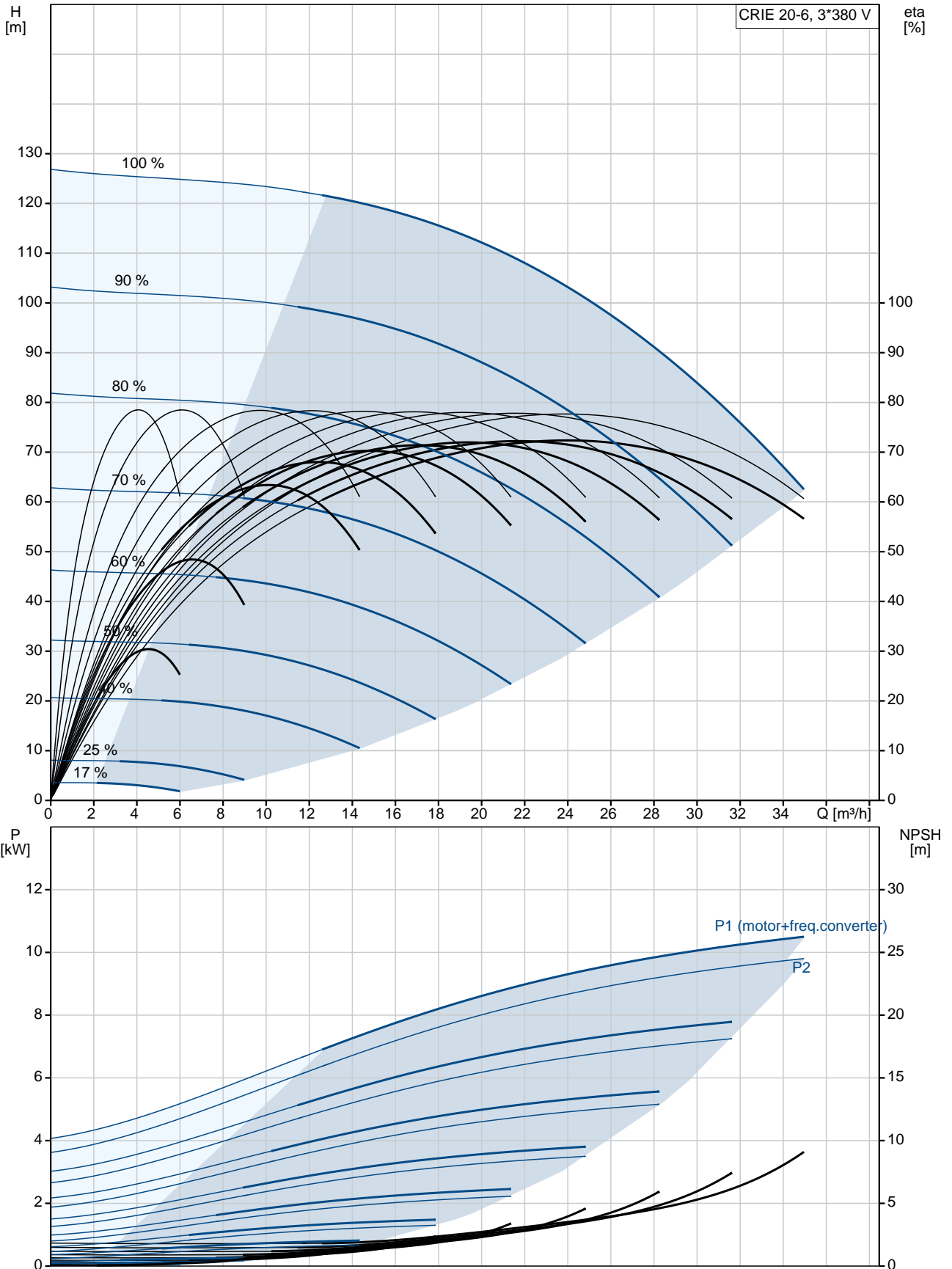

Description	Value
General information:	
Product name:	CRIE 20-6 N-FGJ-A-E-HQQE
Product No:	99071698
EAN number:	5712606196548
Price:	6.965,00 GBP
Technical:	
Pump speed on which pump data are based:	3529 rpm
Rated flow:	25.3 m ³ /h
Rated head:	101.9 m
Head max:	128 m
Stages:	6
Impellers:	6
Number of reduced-diameter impellers:	0
Low NPSH:	N
Pump orientation:	Vertical
Shaft seal arrangement:	Single
Code for shaft seal:	HQQE
Approvals on nameplate:	CE, EAC, ACS
Curve tolerance:	ISO9906:2012 3B
Pump version:	N
Model:	A
Materials:	
Base:	Stainless steel EN 1.4408 AISI 316
Impeller:	Stainless steel EN 1.4301 AISI 304
Material code:	A
Code for rubber:	E
Bearing:	SIC
Installation:	
Maximum ambient temperature:	50 °C
Maximum operating pressure:	16 bar
Max pressure at stated temp:	16 bar / 120 °C 16 bar / -20 °C
Type of connection:	DIN / ANSI / JIS
Size of inlet connection:	DN 50 2 inch
Size of outlet connection:	DN 50 2 inch
Pressure rating for pipe connection:	PN 25
Flange rating inlet:	300 lb
Flange size for motor:	FF300
Connect code:	FGJ
Liquid:	
Pumped liquid:	Water
Liquid temperature range:	-20 .. 120 °C
Liquid temperature during operation:	20 °C
Density:	998.2 kg/m ³
Electrical data:	
Motor standard:	IEC
Motor type:	160MH
IE Efficiency class:	IE5
Rated power - P2:	11 kW
Power (P2) required by pump:	11 kW
Mains frequency:	50 Hz

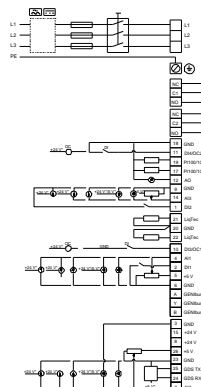
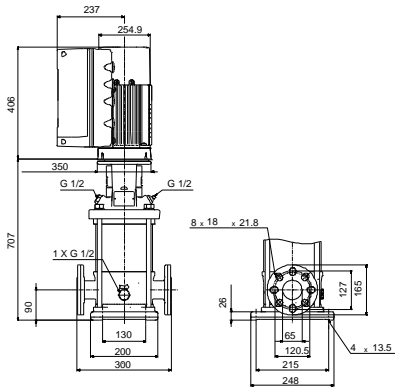
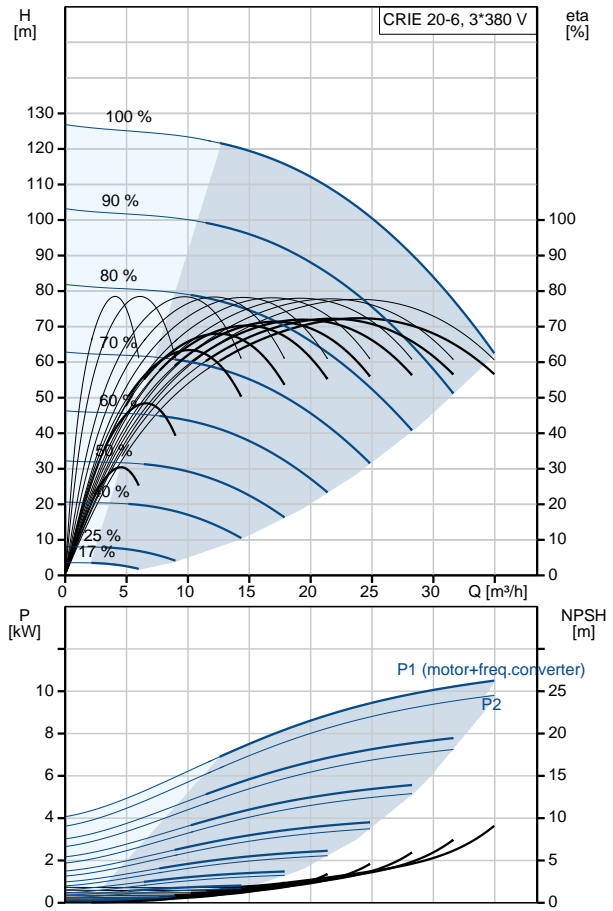



Company name:

Created by:

Phone:

Date:

19/03/2019

Description	Value
Rated voltage:	3 x 380-500 V
Rated current:	20.3-16.0 A
Cos phi - power factor:	0.93-0.90
Rated speed:	360-4000 rpm
Efficiency:	93.1%
Motor efficiency at full load:	93.1 %
Enclosure class (IEC 34-5):	IP55
Insulation class (IEC 85):	F
Motor protec:	YES
Motor No:	98971053
Controls:	
Control panel:	Standard
Function Module:	300
Frequency converter:	Built-in
Pressure sensor:	Y
Others:	
Minimum efficiency index, MEI η_{min} :	0.70
Net weight:	116 kg
Gross weight:	147 kg
Shipping volume:	0.619 m ³
Country of origin:	GB
Custom tariff no.:	84137075

99071698 CRIE 20-6 N-FGJ-A-E-HQQE 50 Hz

