

Position	Qty.	Description
	1	<p>TP 40-120/2 B A-F-Z-BQQE</p>  <p>Note! Product picture may differ from actual product</p> <p>Product No.: 98957964</p> <p>Single-stage, close-coupled, volute pump with in-line suction and discharge ports of identical diameter. The pump is of the top-pull-out design, i.e. the power head (motor, pump head and impeller) can be removed for maintenance or service while the pump housing remains in the pipework.</p> <p>The pump is fitted with an unbalanced rubber bellows seal. The shaft seal is according to EN 12756. Pipework connection is via PN 6/10 DIN flanges (EN 1092-2 and ISO 7005-2).</p> <p>The pump is fitted with a fan-cooled asynchronous motor.</p> <p>Liquid: Pumped liquid: Water Liquid temperature range: -25 .. 120 °C Liquid temperature during operation: 20 °C Density: 998.2 kg/m³</p> <p>Technical: Speed for pump data: 2850 rpm Rated flow: 11.4 m³/h Rated head: 7.4 m Primary shaft seal: BQQE Curve tolerance: ISO9906:2012 3B</p> <p>Materials: Pump housing: Bronze DIN W.-Nr. 2.1050 ASTM B505-C90700 Impeller: Stainless steel DIN W.-Nr. 1.4301 AISI 304</p> <p>Installation: Range of ambient temperature: -30 .. 40 °C Maximum operating pressure: 10 bar Flange standard: DIN Pipe connection: DN 40 Pressure stage: PN 6/10 Port-to-port length: 250 mm Flange size for motor: FT85</p> <p>Electrical data: Motor type: 71B IE Efficiency class: NA Rated power - P2: 0.37 kW Power (P2) required by pump: 0.37 kW Mains frequency: 50 Hz Rated voltage: 1 x 220-230/240 V</p>



Company name:

Created by:

Phone:

Date:

30/06/2017

Position	Qty.	Description
		Rated current: 2,95/2,70 A Starting current: 280 % Cos phi - power factor: 0,99 Rated speed: 2770 rpm Motor efficiency at full load: 60.0-56.0 % Number of poles: 2 Enclosure class (IEC 34-5): 55 Dust/Jetting Insulation class (IEC 85): F Others: Minimum efficiency index, MEI : 0.70 ErP status: EuP Standalone/Prod. Net weight: 24.9 kg Gross weight: 28.4 kg Shipping volume: 0.06 m ³

98957964 TP 40-120/2 B 50 Hz

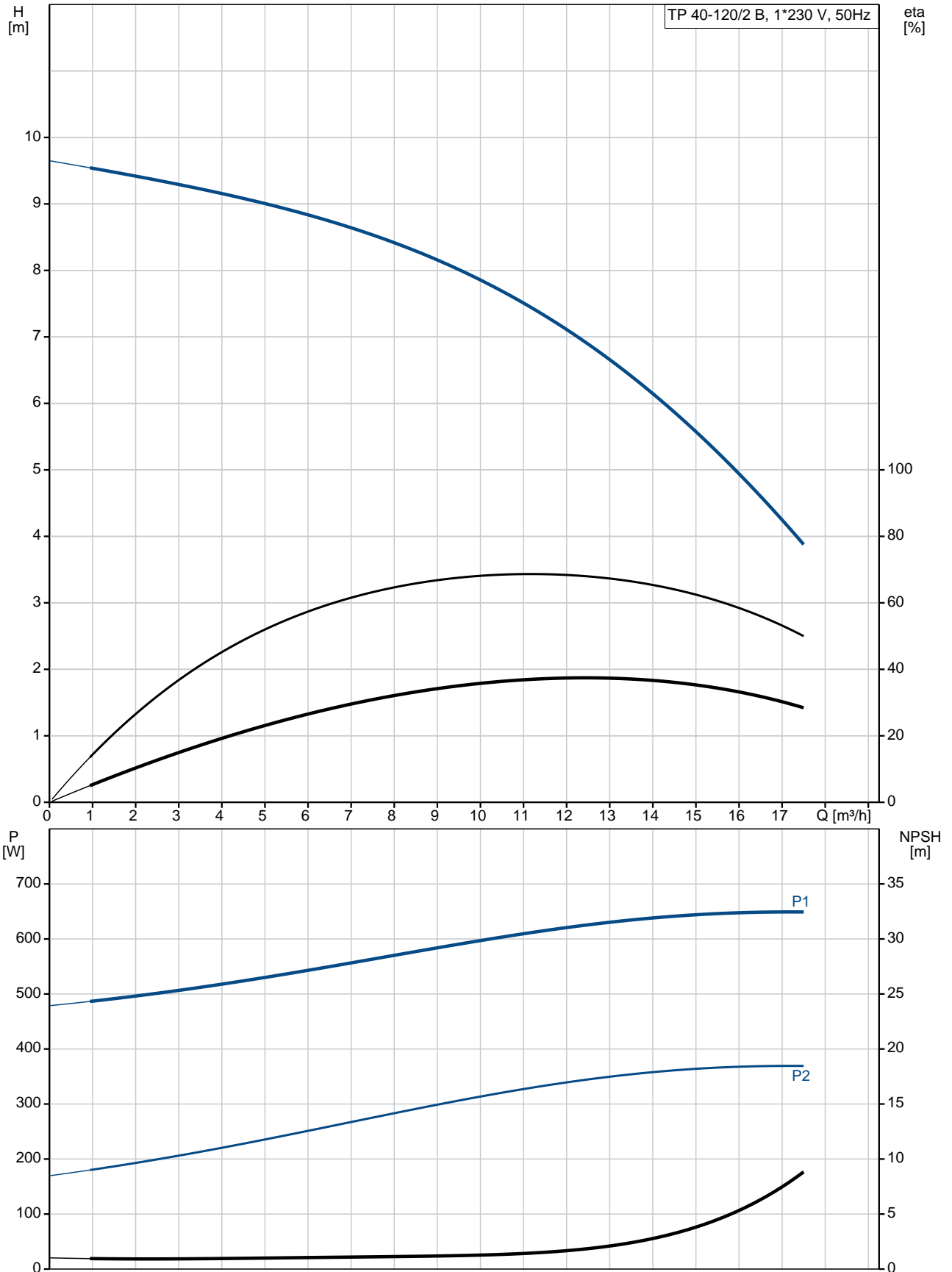

Description	Value
-------------	-------

General information:

Product name:	TP 40-120/2 B A-F-Z-BQQE
Product No:	98957964
EAN number:	5712604244319

Technical:

Speed for pump data:	2850 rpm
Rated flow:	11.4 m ³ /h
Rated head:	7.4 m
Head max:	120 dm
Primary shaft seal:	BQQE
Curve tolerance:	ISO9906:2012 3B
Pump version:	A
Model:	A

Materials:

Pump housing:	Bronze DIN W.-Nr. 2.1050 ASTM B505-C90700
Impeller:	Stainless steel DIN W.-Nr. 1.4301 AISI 304
Material code:	Z

Installation:

Range of ambient temperature:	-30 .. 40 °C
Maximum operating pressure:	10 bar
Flange standard:	DIN
Connect code:	F
Pipe connection:	DN 40
Pressure stage:	PN 6/10
Port-to-port length:	250 mm
Flange size for motor:	FT85

Liquid:

Pumped liquid:	Water
Liquid temperature range:	-25 .. 120 °C
Liquid temperature during operation:	20 °C
Density:	998.2 kg/m ³

Electrical data:

Motor type:	71B
IE Efficiency class:	NA
Rated power - P2:	0.37 kW
Power (P2) required by pump:	0.37 kW
Mains frequency:	50 Hz
Rated voltage:	1 x 220-230/240 V
Rated current:	2,95/2,70 A
Starting current:	280 %
Cos phi - power factor:	0,99
Rated speed:	2770 rpm
Motor efficiency at full load:	60.0-56.0 %
Number of poles:	2
Enclosure class (IEC 34-5):	55 Dust/Jetting
Insulation class (IEC 85):	F
Motor protec:	PTO
Motor No:	85215102

Others:

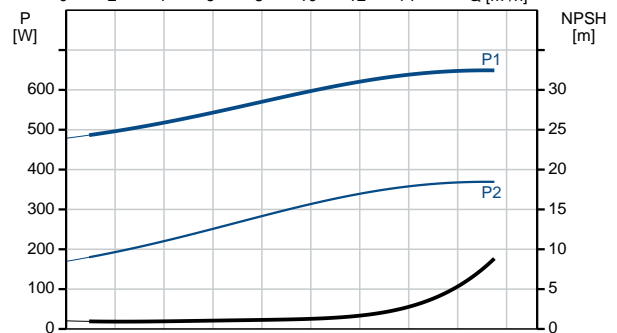
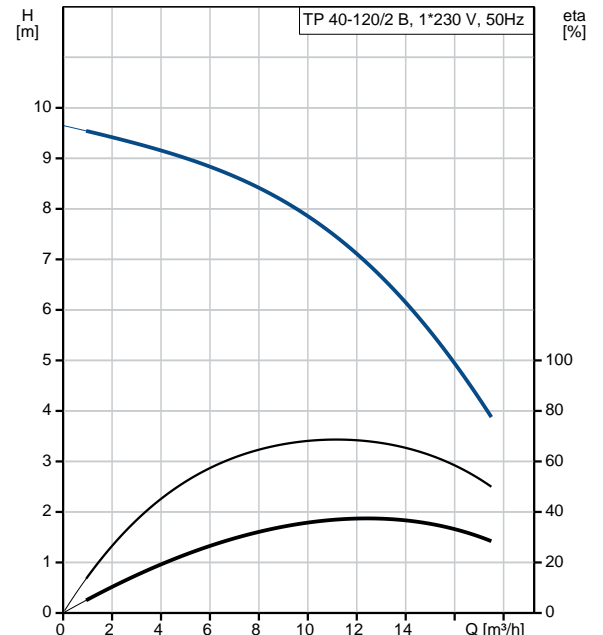



Company name:

Created by:

Phone:

Date:

30/06/2017

Description	Value
Minimum efficiency index, MEI :	0.70
ErP status:	EuP Standalone/Prod.
Net weight:	24.9 kg
Gross weight:	28.4 kg
Shipping volume:	0.06 m ³

98957964 TP 40-120/2 B 50 Hz

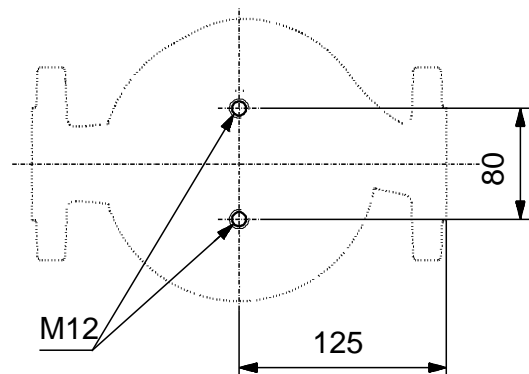
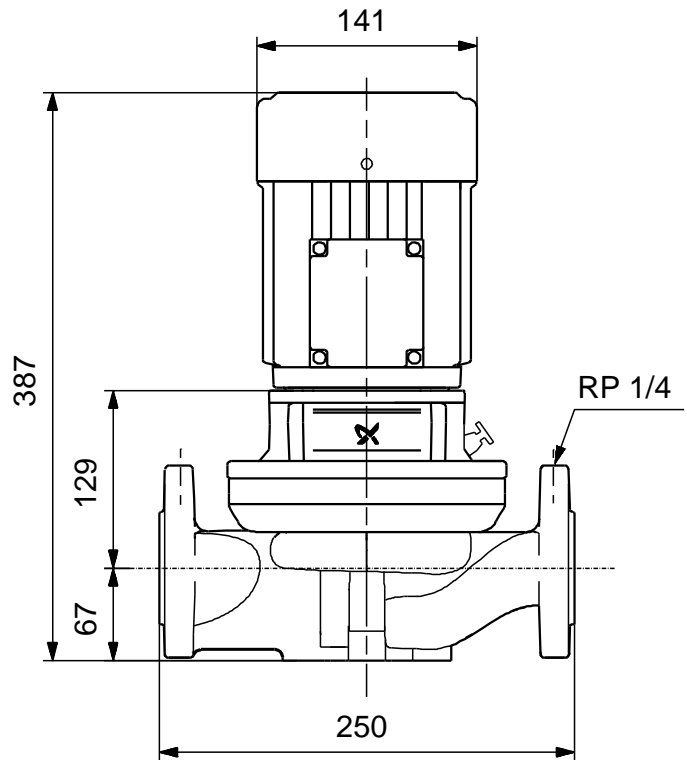
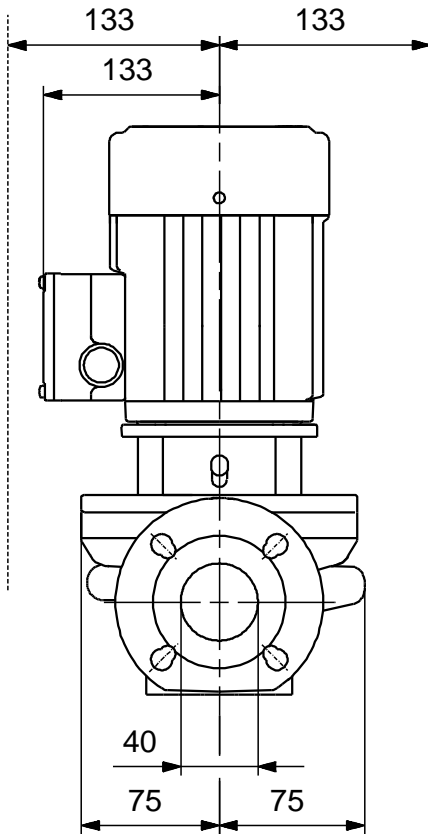

Note! All units are in [mm] unless others are stated.
Disclaimer: This simplified dimensional drawing does not show all details.

98957964 TP 40-120/2 B 50 Hz

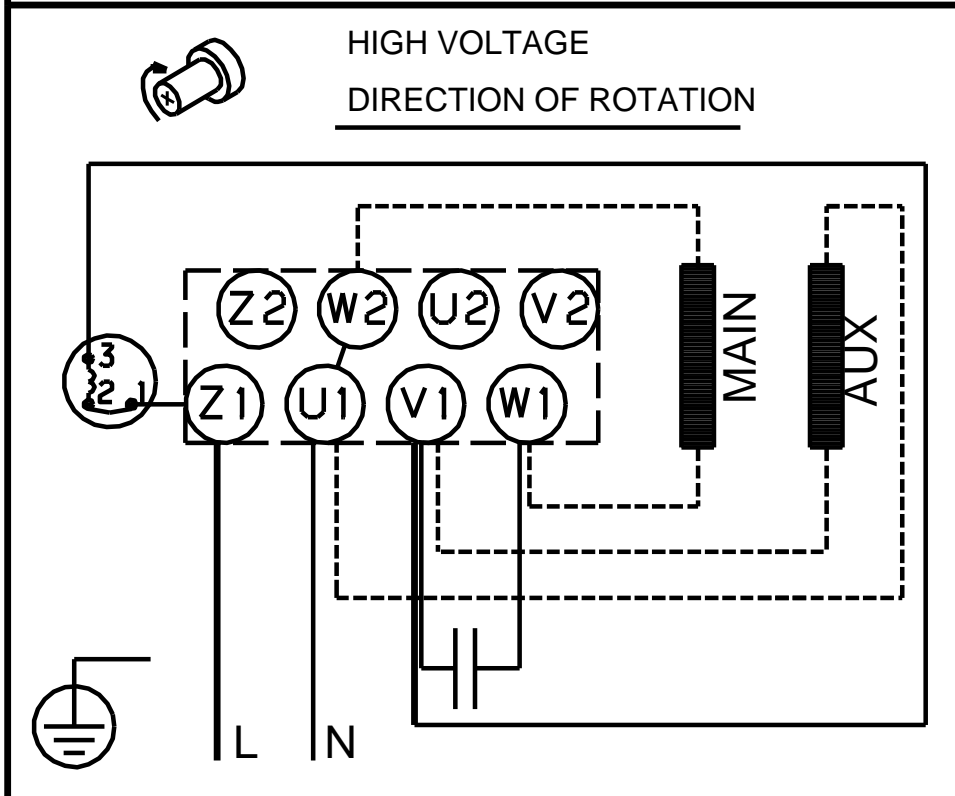
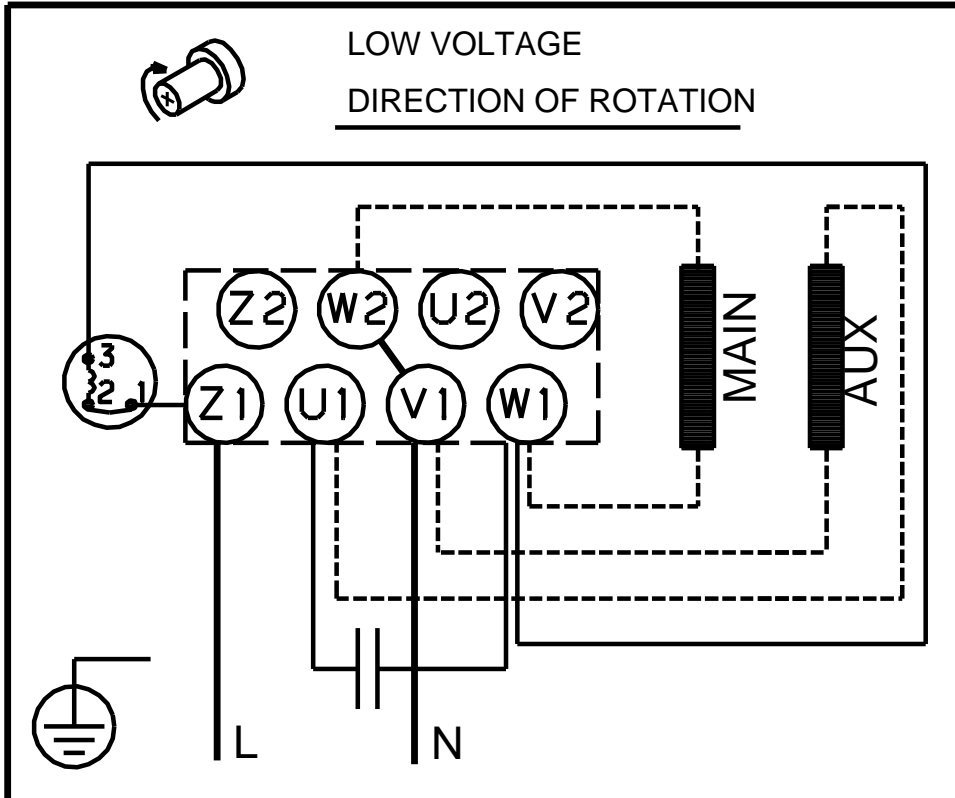

Note! All units are in [mm] unless others are stated.