

Qty. Description

1 SP 14-8



Note! Product picture may differ from actual product

Product No.: [98699355](#)

Submersible borehole pump, suitable for pumping clean water. Can be installed vertically or horizontally. All steel components are made in stainless steel, EN 1.4301 (AISI 304), that ensures high corrosive resistance. This pump carries drinking water approval.

The pump is fitted with a 2.2 kW MS402 motor with sand shield, lip seal, water-lubricated journal bearings and a volume compensating diaphragm. The motor is a canned type submersible motor offering good mechanical stability and high efficiency. Suitable for temperatures up to 40 °C.

The motor is not fitted with a temperature sensor. If temperature monitoring is desired, a Pt1000 sensor can be fitted.

The motor is for direct-on-line starting (DOL).

Further product details

The pump is suitable for applications similar to the following:

- raw-water supply
- irrigation
- groundwater lowering
- pressure boosting
- fountain applications.

The Grundfos SP pump is renowned for its high efficiency and already complies with the requirements of the Minimum Efficiency Index, and therefore Grundfos is amongst the best in class within submersible pumps.



Pump

All pump surfaces that are in contact with pumped liquids are made in stainless steel which makes them corrosion- and wear-resistant. The corrosion diagram below shows the capabilities of the pump and motor in relation to the temperature in Celsius (y-axis) and the concentration of chloride in ppm (x-axis).

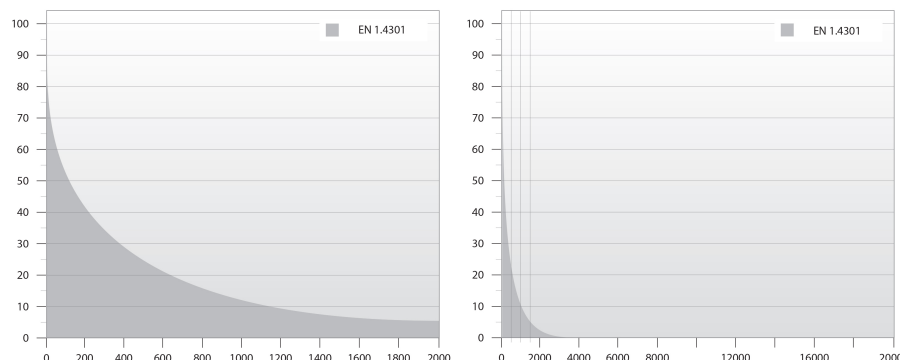

Qty.	Description																																																
	<p>The elastomer parts in the pump offer good wear resistance and long service intervals. The bearings are made of LSR (Liquid Silicone Rubber), sealing rings are made of TPU (Thermoplastic Poly-Urethane) and the non-return valve is made of NBR (Nitrile-Butadiene Rubber). The special elastomer material of the bearings offers increased resistance to sand and other abrasive particles (from 50 to 150 mg/l).</p> <p>In case the pump is used for pumping water with high content of hydrocarbons or solvents, Grundfos offers FKM rubber parts (Fluorocarbon) which are oil and temperature-resistant up to 90 °C.</p> <p>The pump is built with octagonal bearings with sand flush channels that minimise wear. As wear of the pump is inevitable, the pump design allows for easy replacement of all internal wear parts (bearings, impeller, wear rings and seal rings) to maintain high performance and a long lifetime.</p> <p>The suction interconnector is fitted with a strainer to prevent large particles from entering the pump. The suction interconnector is designed to comply with NEMA standards for motor mounting/dimensions.</p> <p>Motor</p> <p>The stator is hermetically encapsulated in stainless steel and the windings are embedded in polymer compound. This results in high mechanical stability, optimum cooling and reduces the risk of short circuits in the windings.</p> <p>The shaft seal is of the lip seal type characterised by low friction against the rotor shaft. The NBR elastomer offers good wear resistance, good elasticity and resistance to particles. The rubber material is approved for use in potable water.</p> <p>The motor can be fitted with a Pt100 or Pt1000 sensor that together with a control unit ensures that the maximum operating temperature conditions are not exceeded.</p> <p>Liquid:</p> <table data-bbox="199 981 699 1126"> <tr> <td>Pumped liquid:</td> <td>Water</td> </tr> <tr> <td>Maximum liquid temperature:</td> <td>40 °C</td> </tr> <tr> <td>Max liquid t at 0.15 m/sec:</td> <td>40 °C</td> </tr> <tr> <td>Selected liquid temperature:</td> <td>20 °C</td> </tr> <tr> <td>Density:</td> <td>998.2 kg/m³</td> </tr> </table> <p>Technical:</p> <table data-bbox="199 1189 820 1395"> <tr> <td>Pump speed on which pump data are based:</td> <td>2900 rpm</td> </tr> <tr> <td>Rated flow:</td> <td>14 m³/h</td> </tr> <tr> <td>Rated head:</td> <td>34.1 m</td> </tr> <tr> <td>Shaft seal for motor:</td> <td>LIPSEAL</td> </tr> <tr> <td>Approvals on nameplate:</td> <td>CE,EAC</td> </tr> <tr> <td>Curve tolerance:</td> <td>ISO9906:2012 3B</td> </tr> <tr> <td>Motor version:</td> <td>T40</td> </tr> </table> <p>Materials:</p> <table data-bbox="199 1453 770 1720"> <tr> <td>Pump:</td> <td>Stainless steel EN 1.4301 AISI AISI 304</td> </tr> <tr> <td>Impeller:</td> <td>Stainless steel EN 1.4301 AISI AISI 304</td> </tr> <tr> <td>Motor:</td> <td>Stainless steel DIN W.-Nr. 1.4301 AISI 304</td> </tr> </table> <p>Installation:</p> <table data-bbox="199 1783 635 1839"> <tr> <td>Pump outlet:</td> <td>Rp2</td> </tr> <tr> <td>Motor diameter:</td> <td>4 inch</td> </tr> </table> <p>Electrical data:</p> <table data-bbox="199 1901 770 2105"> <tr> <td>Motor type:</td> <td>MS402</td> </tr> <tr> <td>Rated power - P2:</td> <td>2.2 kW</td> </tr> <tr> <td>Power (P2) required by pump:</td> <td>2.2 kW</td> </tr> <tr> <td>Mains frequency:</td> <td>50 Hz</td> </tr> <tr> <td>Rated voltage:</td> <td>3 x 380-400-415 V</td> </tr> <tr> <td>Rated current:</td> <td>5.50-5.50-5.70 A</td> </tr> <tr> <td>Starting current:</td> <td>440-460-470 %</td> </tr> </table>	Pumped liquid:	Water	Maximum liquid temperature:	40 °C	Max liquid t at 0.15 m/sec:	40 °C	Selected liquid temperature:	20 °C	Density:	998.2 kg/m ³	Pump speed on which pump data are based:	2900 rpm	Rated flow:	14 m ³ /h	Rated head:	34.1 m	Shaft seal for motor:	LIPSEAL	Approvals on nameplate:	CE,EAC	Curve tolerance:	ISO9906:2012 3B	Motor version:	T40	Pump:	Stainless steel EN 1.4301 AISI AISI 304	Impeller:	Stainless steel EN 1.4301 AISI AISI 304	Motor:	Stainless steel DIN W.-Nr. 1.4301 AISI 304	Pump outlet:	Rp2	Motor diameter:	4 inch	Motor type:	MS402	Rated power - P2:	2.2 kW	Power (P2) required by pump:	2.2 kW	Mains frequency:	50 Hz	Rated voltage:	3 x 380-400-415 V	Rated current:	5.50-5.50-5.70 A	Starting current:	440-460-470 %
Pumped liquid:	Water																																																
Maximum liquid temperature:	40 °C																																																
Max liquid t at 0.15 m/sec:	40 °C																																																
Selected liquid temperature:	20 °C																																																
Density:	998.2 kg/m ³																																																
Pump speed on which pump data are based:	2900 rpm																																																
Rated flow:	14 m ³ /h																																																
Rated head:	34.1 m																																																
Shaft seal for motor:	LIPSEAL																																																
Approvals on nameplate:	CE,EAC																																																
Curve tolerance:	ISO9906:2012 3B																																																
Motor version:	T40																																																
Pump:	Stainless steel EN 1.4301 AISI AISI 304																																																
Impeller:	Stainless steel EN 1.4301 AISI AISI 304																																																
Motor:	Stainless steel DIN W.-Nr. 1.4301 AISI 304																																																
Pump outlet:	Rp2																																																
Motor diameter:	4 inch																																																
Motor type:	MS402																																																
Rated power - P2:	2.2 kW																																																
Power (P2) required by pump:	2.2 kW																																																
Mains frequency:	50 Hz																																																
Rated voltage:	3 x 380-400-415 V																																																
Rated current:	5.50-5.50-5.70 A																																																
Starting current:	440-460-470 %																																																



Company name:

Created by:

Phone:

Date:

05/11/2020

Qty.	Description
------	-------------

Cos phi - power factor:	0.85-0.82-0.77
Rated speed:	2850-2860-2870 rpm
Start. method:	direct-on-line
Enclosure class (IEC 34-5):	IP68
Insulation class (IEC 85):	B
Built-in temp. transmitter:	no
Motor No:	79192007

Others:

Minimum efficiency index, MEI $\eta_{\%}$:	0.50
ErP status:	EuP Standalone/Prod.
Net weight:	22.7 kg
Gross weight:	25.2 kg
Shipping volume:	0.021 m ³
Danish VVS No.:	388482008
Finnish LVI No.:	4762707
Country of origin:	DK
Custom tariff no.:	84137029

98699355 SP 14-8 50 Hz

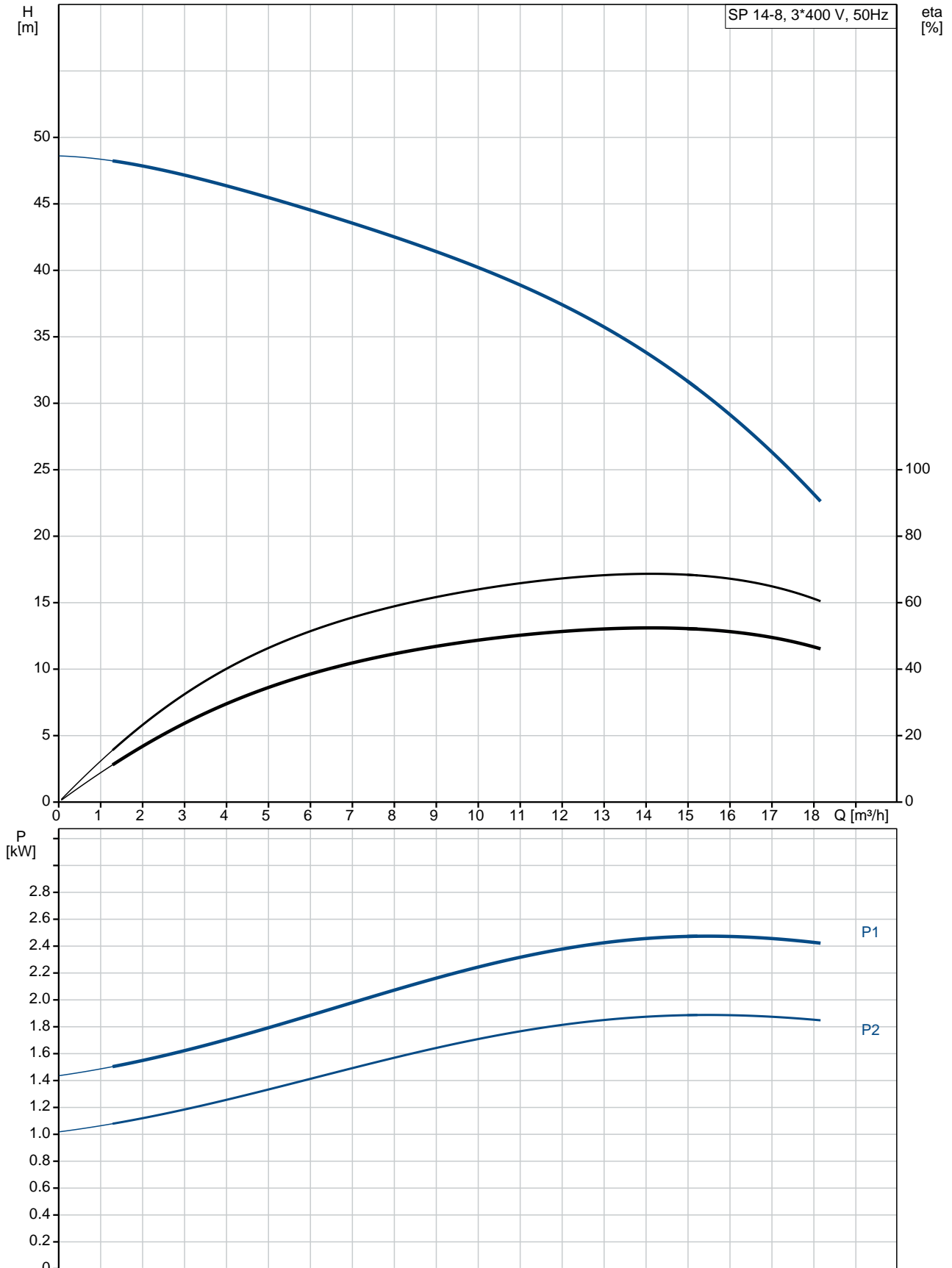

Description	Value
General information:	
Product name:	SP 14-8
Product No:	98699355
EAN number:	5712600111936
Price:	GBP 1538
Technical:	
Pump speed on which pump data are based:	2900 rpm
Rated flow:	14 m ³ /h
Rated head:	34.1 m
Stages:	8
Impeller reduc.:	NONE
Shaft seal for motor:	LIPSEAL
Approvals on nameplate:	CE,EAC
Curve tolerance:	ISO9906:2012 3B
Model:	A
Valve:	YES
Motor version:	T40
Materials:	
Pump:	Stainless steel
Pump:	EN 1.4301
Pump:	AISI AISI 304
Impeller:	Stainless steel
Impeller:	EN 1.4301
Impeller:	AISI AISI 304
Motor:	Stainless steel
Motor:	DIN W.-Nr. 1.4301
Motor:	AISI 304
Installation:	
Pump outlet:	Rp2
Motor diameter:	4 inch
Liquid:	
Pumped liquid:	Water
Maximum liquid temperature:	40 °C
Max liquid t at 0.15 m/sec:	40 °C
Selected liquid temperature:	20 °C
Density:	998.2 kg/m ³
Electrical data:	
Motor type:	MS402
Applic. motor:	NEMA
Rated power - P2:	2.2 kW
Power (P2) required by pump:	2.2 kW
Mains frequency:	50 Hz
Rated voltage:	3 x 380-400-415 V
Rated current:	5.50-5.50-5.70 A
Starting current:	440-460-470 %
Cos phi - power factor:	0.85-0.82-0.77
Rated speed:	2850-2860-2870 rpm
Start. method:	direct-on-line
Enclosure class (IEC 34-5):	IP68
Insulation class (IEC 85):	B
Motor protec:	NONE
Thermal protec:	external
Built-in temp. transmitter:	no
Motor No:	79192007
Others:	
Minimum efficiency index, MEI %:	0.50
ErP status:	EuP Standalone/Prod.

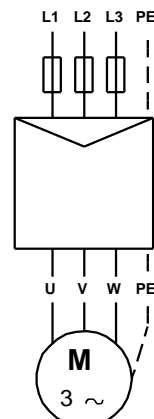
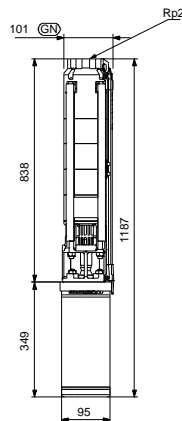
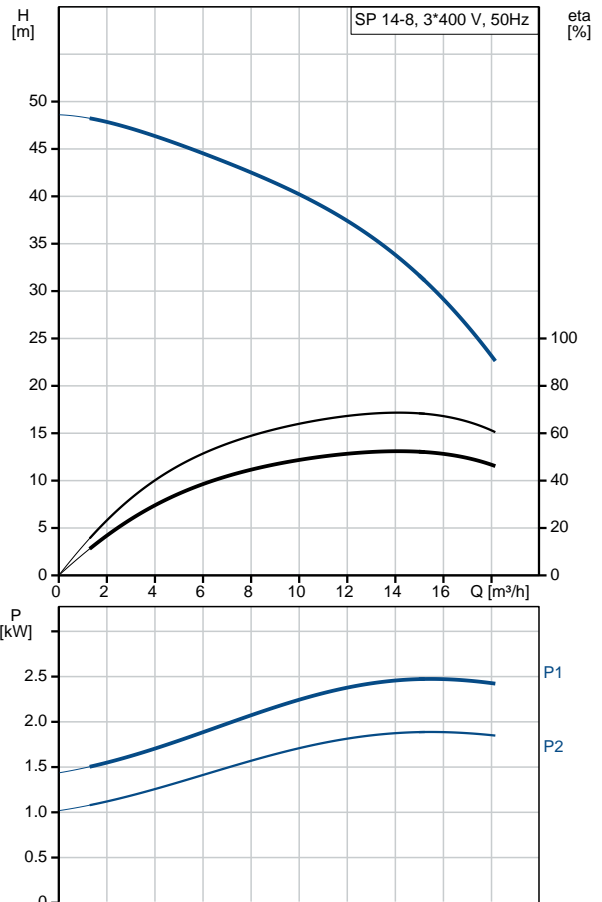



Company name:

Created by:

Phone:

Date: 05/11/2020

Description	Value
Net weight:	22.7 kg
Gross weight:	25.2 kg
Shipping volume:	0.021 m ³
Danish VVS No.:	388482008
Finnish LVI No.:	4762707
Country of origin:	DK
Custom tariff no.:	84137029

98699355 SP 14-8 50 Hz

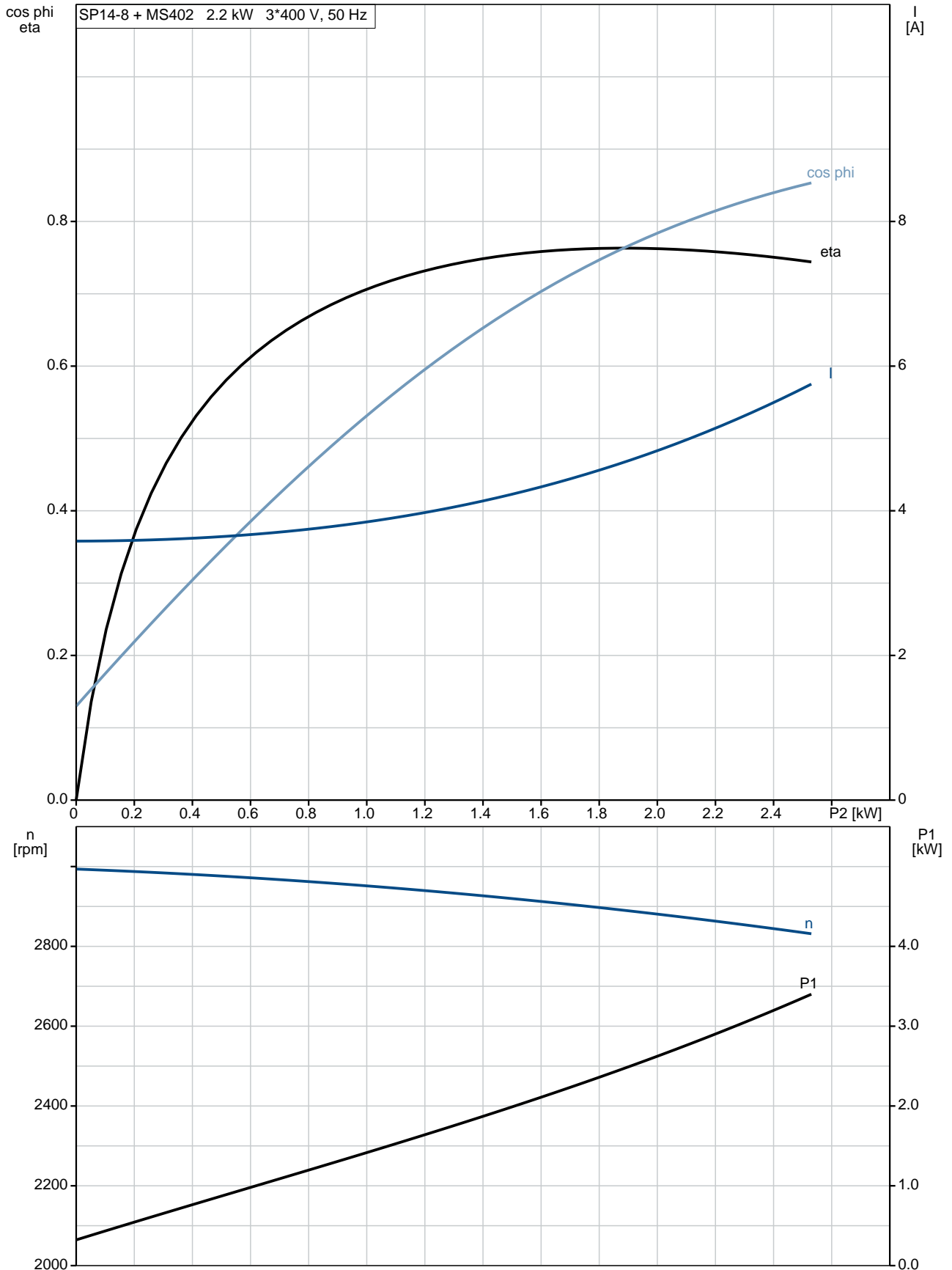

98699355 SP 14-8 50 Hz

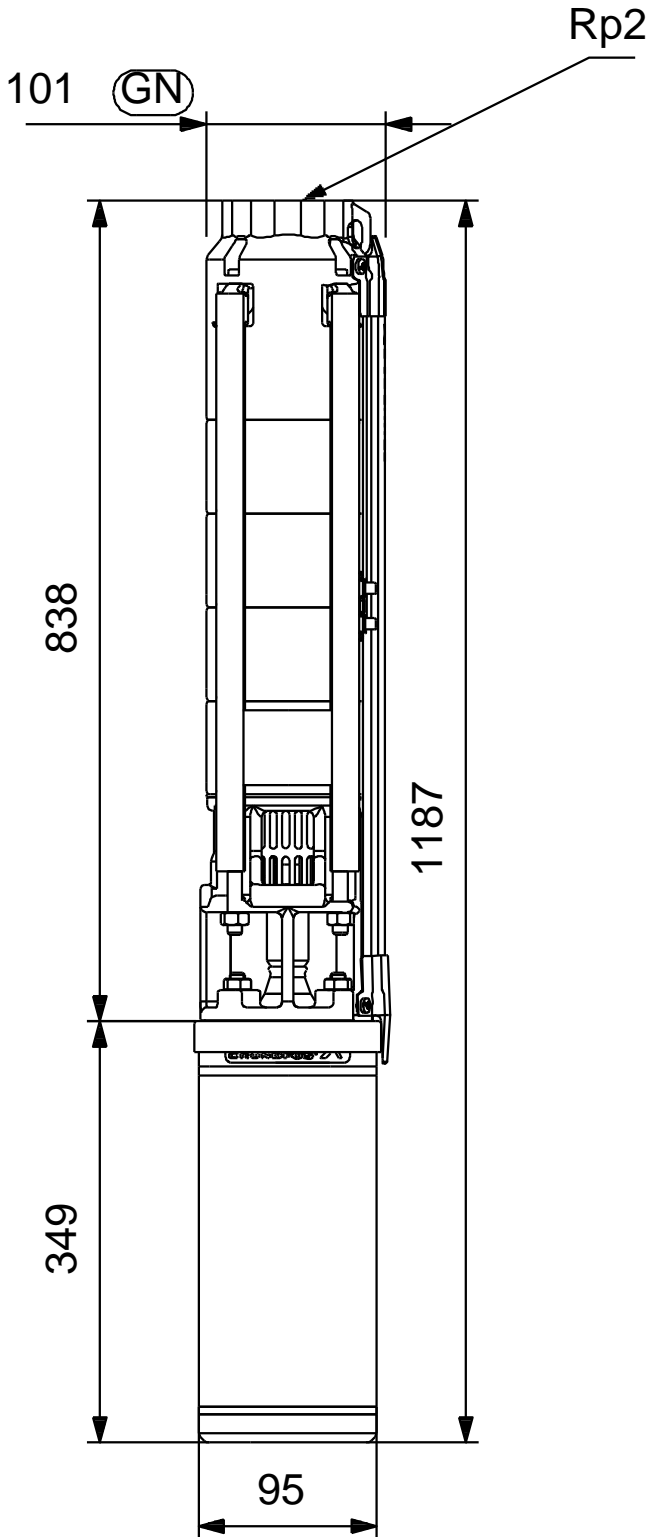

Note! All units are in [mm] unless others are stated.
Disclaimer: This simplified dimensional drawing does not show all details.

98699355 SP 14-8 50 Hz



Note! All units are in [mm] unless others are stated.