

Count	Description																														
1	<p data-bbox="225 338 319 367">SP 7-51</p>  <p data-bbox="619 837 1072 862" style="text-align: center;">Product photo could vary from the actual product</p> <p data-bbox="225 869 494 896">Product No.: 98699198</p> <p data-bbox="225 898 833 1014">Multi-stage submersible pump for raw water supply, groundwater lowering and pressure boosting. The pump is suitable for pumping clean, thin, non-aggressive liquids without solid particles or fibers.</p> <p data-bbox="225 1048 769 1164">The pump is made entirely of Stainless steel DIN W.-Nr. EN 1.4301 and suitable for horizontal and vertical installation. The pump is fitted with a built-in non-return valve.</p> <p data-bbox="225 1198 769 1283">The motor is a 3-phase motor of the canned type with a sand shield, liquid-lubricated bearings and pressure-equalizing diaphragm.</p> <p data-bbox="225 1317 311 1344">Liquid:</p> <table data-bbox="225 1346 737 1491"> <tr> <td>Pumped liquid:</td> <td>Water</td> </tr> <tr> <td>Maximum liquid temperature:</td> <td>104 °F</td> </tr> <tr> <td>Max liquid temperature at 0.15 m/sec:</td> <td>104 °F</td> </tr> <tr> <td>Selected liquid temperature:</td> <td>68 °F</td> </tr> <tr> <td>Density:</td> <td>62.29 lb/ft³</td> </tr> </table> <p data-bbox="225 1525 351 1552">Technical:</p> <table data-bbox="225 1554 826 1758"> <tr> <td>Pump speed on which pump data is based:</td> <td>2900 rpm</td> </tr> <tr> <td>Rated flow:</td> <td>30.8 US gpm</td> </tr> <tr> <td>Rated head:</td> <td>771 ft</td> </tr> <tr> <td>Shaft seal for motor:</td> <td>HM/CER</td> </tr> <tr> <td>Approvals on nameplate:</td> <td>CE,EAC</td> </tr> <tr> <td>Curve tolerance:</td> <td>ISO9906:2012 3B</td> </tr> <tr> <td>Motor version:</td> <td>T40</td> </tr> </table> <p data-bbox="225 1792 343 1818">Materials:</p> <table data-bbox="225 1821 794 2085"> <tr> <td>Pump:</td> <td>Stainless steel EN 1.4301 AISI 304</td> </tr> <tr> <td>Impeller:</td> <td>Stainless steel EN 1.4301 AISI 304</td> </tr> <tr> <td>Motor:</td> <td>Stainless steel DIN W.-Nr. 1.4301 AISI 304</td> </tr> </table>	Pumped liquid:	Water	Maximum liquid temperature:	104 °F	Max liquid temperature at 0.15 m/sec:	104 °F	Selected liquid temperature:	68 °F	Density:	62.29 lb/ft ³	Pump speed on which pump data is based:	2900 rpm	Rated flow:	30.8 US gpm	Rated head:	771 ft	Shaft seal for motor:	HM/CER	Approvals on nameplate:	CE,EAC	Curve tolerance:	ISO9906:2012 3B	Motor version:	T40	Pump:	Stainless steel EN 1.4301 AISI 304	Impeller:	Stainless steel EN 1.4301 AISI 304	Motor:	Stainless steel DIN W.-Nr. 1.4301 AISI 304
Pumped liquid:	Water																														
Maximum liquid temperature:	104 °F																														
Max liquid temperature at 0.15 m/sec:	104 °F																														
Selected liquid temperature:	68 °F																														
Density:	62.29 lb/ft ³																														
Pump speed on which pump data is based:	2900 rpm																														
Rated flow:	30.8 US gpm																														
Rated head:	771 ft																														
Shaft seal for motor:	HM/CER																														
Approvals on nameplate:	CE,EAC																														
Curve tolerance:	ISO9906:2012 3B																														
Motor version:	T40																														
Pump:	Stainless steel EN 1.4301 AISI 304																														
Impeller:	Stainless steel EN 1.4301 AISI 304																														
Motor:	Stainless steel DIN W.-Nr. 1.4301 AISI 304																														



Company name:

Created by:

Phone:

Date:

6/13/2019

Count	Description
	Installation: Pump outlet: RP1 1/2 Motor diameter: 4 inch
	Electrical data: Motor type: MS4000 Rated power - P2: 10 HP Power (P2) required by pump: 10 HP Main frequency: 50 Hz Rated voltage: 3 x 380-400-415 V Rated current: 18.4-18.8-19.6 A Starting current: 490-530-550 % Cos phi - power factor: 0.83-0.78-0.72 Rated speed: 2830-2850-2870 rpm Start. method: direct-on-line Enclosure class (IEC 34-5): IP68 Insulation class (IEC 85): F Built-in temperature transmitter: yes Motor Number: 79195512
	Others: Minimum efficiency index, MEI : 0.70 ErP status: EuP Standalone/Prod. Net weight: 144 lb Gross weight: 245 lb Shipping volume: 14.5 ft ³ Danish VVS No.: 388461051



Company name:

Created by:

Phone:

Date:

6/13/2019

98699198 SP 7-51 50 Hz

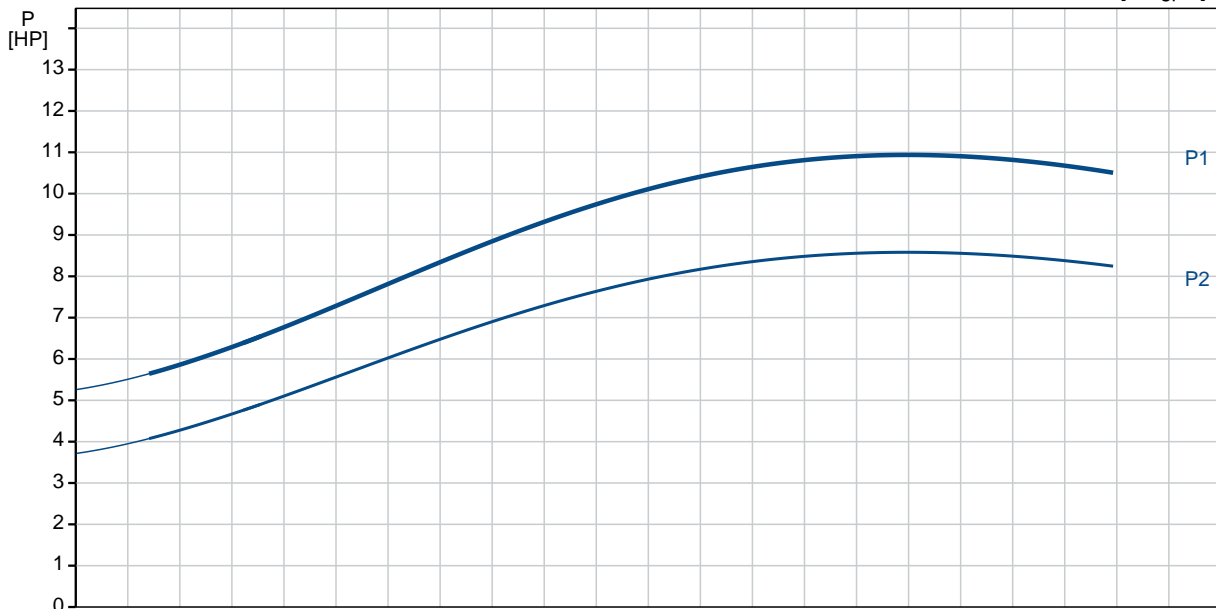
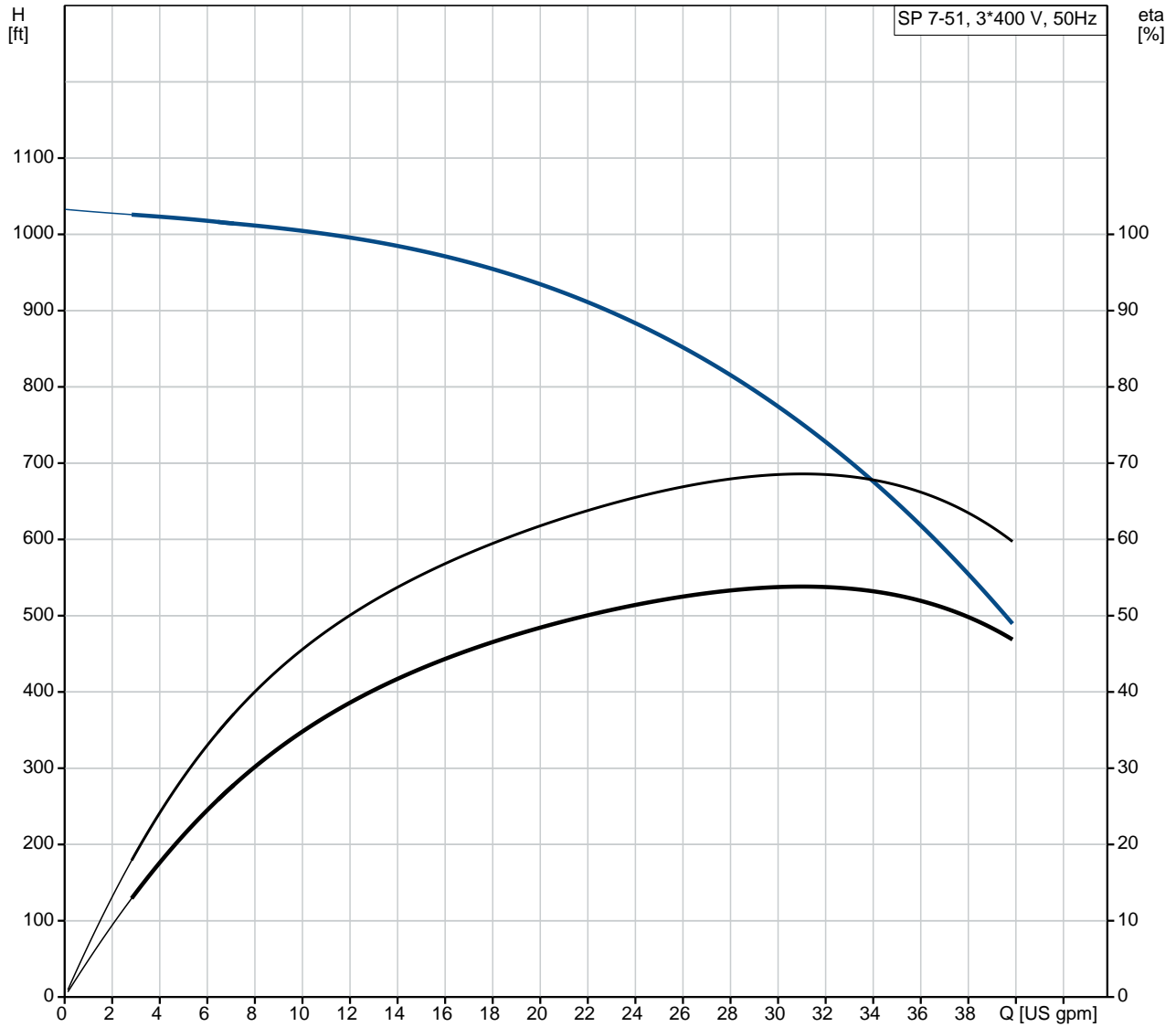

Description	Value
General information:	
Product name:	SP 7-51
Product No.:	98699198
EAN:	5712600108790
Technical:	
Pump speed on which pump data is based:	2900 rpm
Rated flow:	30.8 US gpm
Rated head:	771 ft
Stages:	51
Impeller reduc.:	NONE
Shaft seal for motor:	HM/CER
Approvals on nameplate:	CE, EAC
Curve tolerance:	ISO9906:2012 3B
Model:	A
Valve:	YES
Motor version:	T40
Materials:	
Pump:	Stainless steel EN 1.4301 AISI 304
Impeller:	Stainless steel EN 1.4301 AISI 304
Motor:	Stainless steel DIN W.-Nr. 1.4301 AISI 304
Installation:	
Pump outlet:	RP1 1/2
Motor diameter:	4 inch
Liquid:	
Pumped liquid:	Water
Maximum liquid temperature:	104 °F
Max liquid temperature at 0.15 m/sec:	104 °F
Selected liquid temperature:	68 °F
Density:	62.29 lb/ft³
Electrical data:	
Motor type:	MS4000
Applic. motor:	NEMA
Rated power - P2:	10 HP
Power (P2) required by pump:	10 HP
Main frequency:	50 Hz
Rated voltage:	3 x 380-400-415 V
Rated current:	18.4-18.8-19.6 A
Starting current:	490-530-550 %
Cos phi - power factor:	0.83-0.78-0.72
Rated speed:	2830-2850-2870 rpm
Start. method:	direct-on-line
Enclosure class (IEC 34-5):	IP68
Insulation class (IEC 85):	F
Motor protection:	NONE
Thermal protec:	external
Built-in temperature transmitter:	yes
Motor Number:	79195512
Others:	
Minimum efficiency index, MEI :	0.70
ErP status:	EuP Standalone/Prod.
Net weight:	144 lb

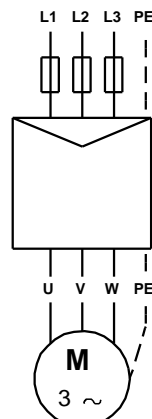
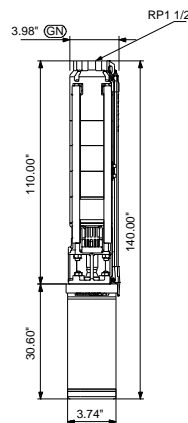
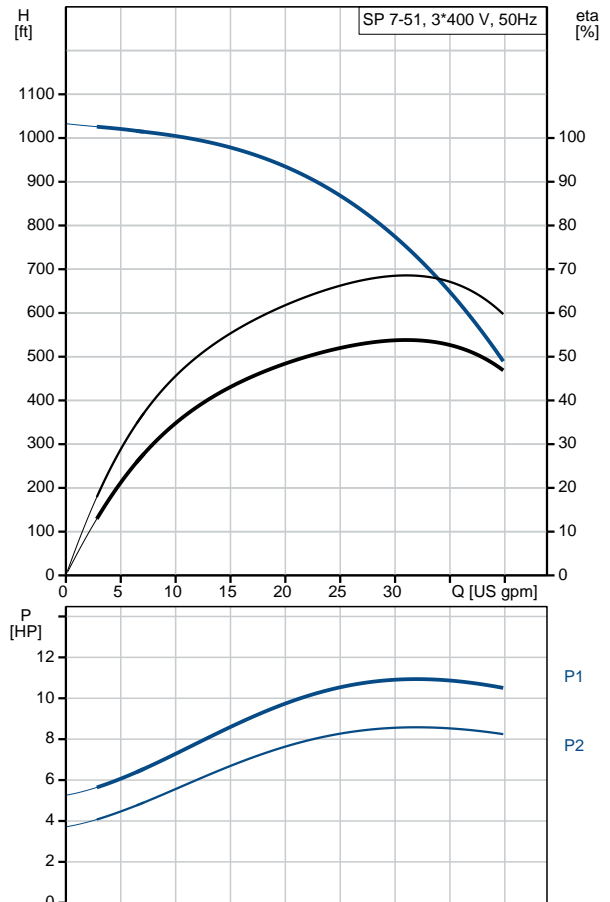



Company name:

Created by:

Phone:

Date:

6/13/2019

Description	Value
Gross weight:	245 lb
Shipping volume:	14.5 ft ³
Danish VVS No.:	388461051

98699198 SP 7-51 50 Hz

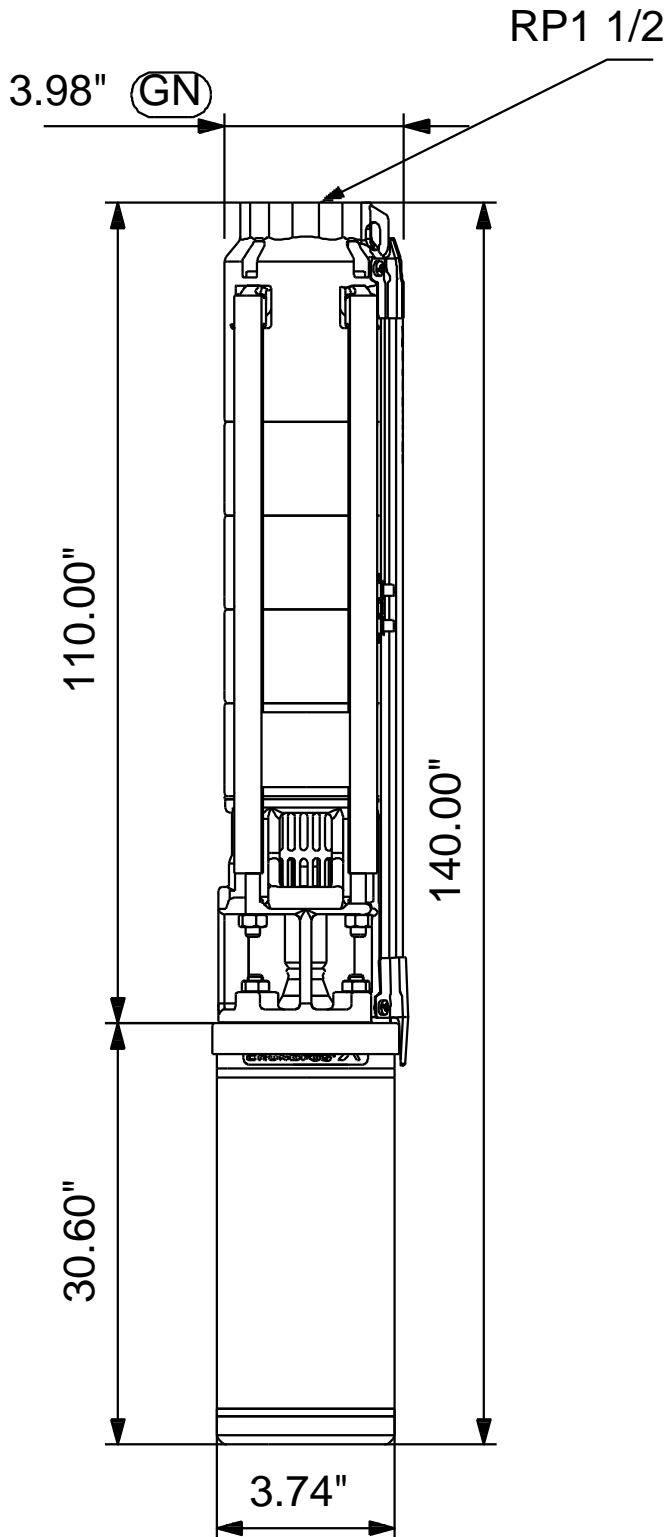

Note! All units are in [in] unless otherwise stated.
Disclaimer: This simplified dimensional drawing does not show all details.

98699198 SP 7-51 50 Hz

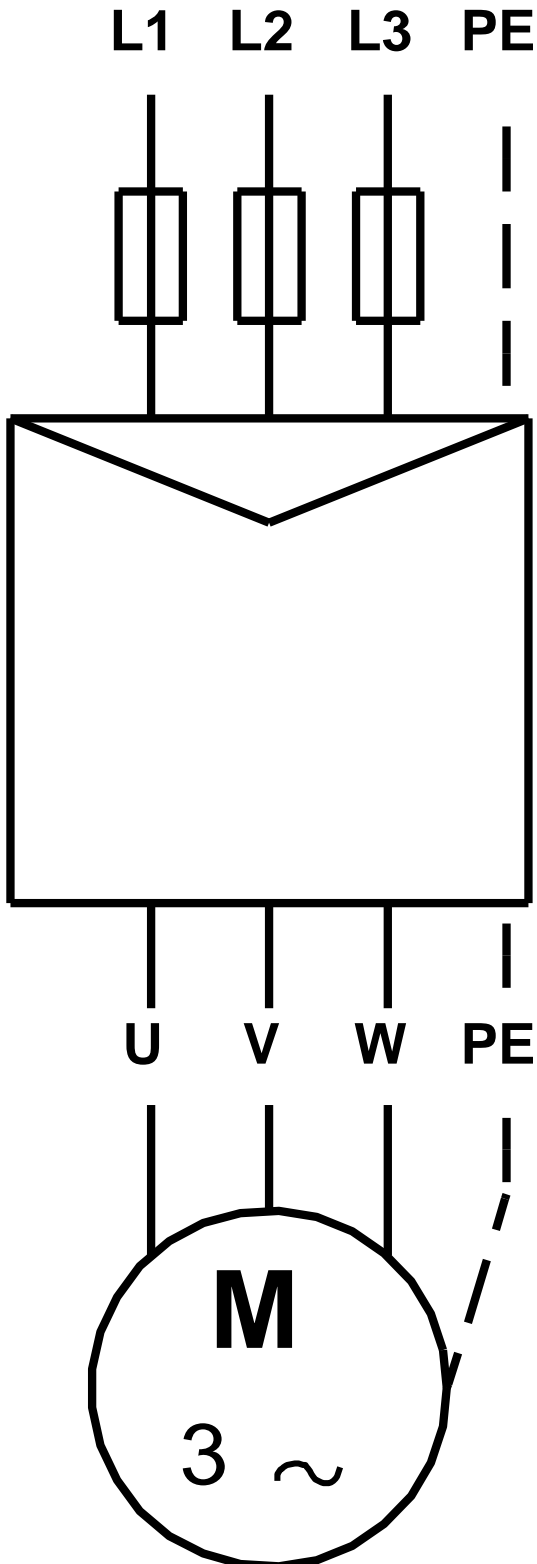

All units are [in] unless otherwise presented.



Company name:

Created by:

Phone:

Date:

6/13/2019

Order Data:

Product name: SP 7-51

Amount: 1

Product No.: 98699198

Total: Price on request
