

Count	Description																														
1	<p data-bbox="225 338 319 360">SP 7-31</p> <div data-bbox="405 376 424 860" style="text-align: center;">  </div> <p data-bbox="619 837 1072 860" style="text-align: center;">Product photo could vary from the actual product</p> <p data-bbox="225 869 491 891">Product No.: 98699184</p> <p data-bbox="225 898 831 1010">Multi-stage submersible pump for raw water supply, groundwater lowering and pressure boosting. The pump is suitable for pumping clean, thin, non-aggressive liquids without solid particles or fibers.</p> <p data-bbox="225 1048 767 1160">The pump is made entirely of Stainless steel DIN W.-Nr. EN 1.4301 and suitable for horizontal and vertical installation. The pump is fitted with a built-in non-return valve.</p> <p data-bbox="225 1198 767 1279">The motor is a 3-phase motor of the canned type with a sand shield, liquid-lubricated bearings and pressure-equalizing diaphragm.</p> <p data-bbox="225 1317 311 1339">Liquid:</p> <table data-bbox="225 1346 735 1491"> <tr> <td>Pumped liquid:</td> <td>Water</td> </tr> <tr> <td>Maximum liquid temperature:</td> <td>104 °F</td> </tr> <tr> <td>Max liquid temperature at 0.15 m/sec:</td> <td>104 °F</td> </tr> <tr> <td>Selected liquid temperature:</td> <td>68 °F</td> </tr> <tr> <td>Density:</td> <td>62.29 lb/ft³</td> </tr> </table> <p data-bbox="225 1525 347 1547">Technical:</p> <table data-bbox="225 1554 826 1760"> <tr> <td>Pump speed on which pump data is based:</td> <td>2900 rpm</td> </tr> <tr> <td>Rated flow:</td> <td>30.8 US gpm</td> </tr> <tr> <td>Rated head:</td> <td>467.5 ft</td> </tr> <tr> <td>Shaft seal for motor:</td> <td>HM/CER</td> </tr> <tr> <td>Approvals on nameplate:</td> <td>CE,EAC</td> </tr> <tr> <td>Curve tolerance:</td> <td>ISO9906:2012 3B</td> </tr> <tr> <td>Motor version:</td> <td>T40</td> </tr> </table> <p data-bbox="225 1794 343 1816">Materials:</p> <table data-bbox="225 1823 794 2085"> <tr> <td>Pump:</td> <td>Stainless steel EN 1.4301 AISI 304</td> </tr> <tr> <td>Impeller:</td> <td>Stainless steel EN 1.4301 AISI 304</td> </tr> <tr> <td>Motor:</td> <td>Stainless steel DIN W.-Nr. 1.4301 AISI 304</td> </tr> </table>	Pumped liquid:	Water	Maximum liquid temperature:	104 °F	Max liquid temperature at 0.15 m/sec:	104 °F	Selected liquid temperature:	68 °F	Density:	62.29 lb/ft³	Pump speed on which pump data is based:	2900 rpm	Rated flow:	30.8 US gpm	Rated head:	467.5 ft	Shaft seal for motor:	HM/CER	Approvals on nameplate:	CE,EAC	Curve tolerance:	ISO9906:2012 3B	Motor version:	T40	Pump:	Stainless steel EN 1.4301 AISI 304	Impeller:	Stainless steel EN 1.4301 AISI 304	Motor:	Stainless steel DIN W.-Nr. 1.4301 AISI 304
Pumped liquid:	Water																														
Maximum liquid temperature:	104 °F																														
Max liquid temperature at 0.15 m/sec:	104 °F																														
Selected liquid temperature:	68 °F																														
Density:	62.29 lb/ft³																														
Pump speed on which pump data is based:	2900 rpm																														
Rated flow:	30.8 US gpm																														
Rated head:	467.5 ft																														
Shaft seal for motor:	HM/CER																														
Approvals on nameplate:	CE,EAC																														
Curve tolerance:	ISO9906:2012 3B																														
Motor version:	T40																														
Pump:	Stainless steel EN 1.4301 AISI 304																														
Impeller:	Stainless steel EN 1.4301 AISI 304																														
Motor:	Stainless steel DIN W.-Nr. 1.4301 AISI 304																														



Company name:

Created by:

Phone:

Date:

6/13/2019

Count	Description
	Installation: Pump outlet: RP1 1/2 Motor diameter: 4 inch
	Electrical data: Motor type: MS4000 Rated power - P2: 5.5 HP Power (P2) required by pump: 5.5 HP Main frequency: 50 Hz Rated voltage: 3 x 380-400-415 V Rated current: 9.75-9.60-9.80 A Starting current: 460-500-530 % Cos phi - power factor: 0.85-0.80-0.77 Rated speed: 2850-2865-2875 rpm Start. method: direct-on-line Enclosure class (IEC 34-5): IP68 Insulation class (IEC 85): F Built-in temperature transmitter: No Motor Number: 79194510
	Others: Minimum efficiency index, MEI : 0.70 ErP status: EuP Standalone/Prod. Net weight: 96.8 lb Gross weight: 175 lb Shipping volume: 10.4 ft ³



Company name:

Created by:

Phone:

Date:

6/13/2019

98699184 SP 7-31 50 Hz

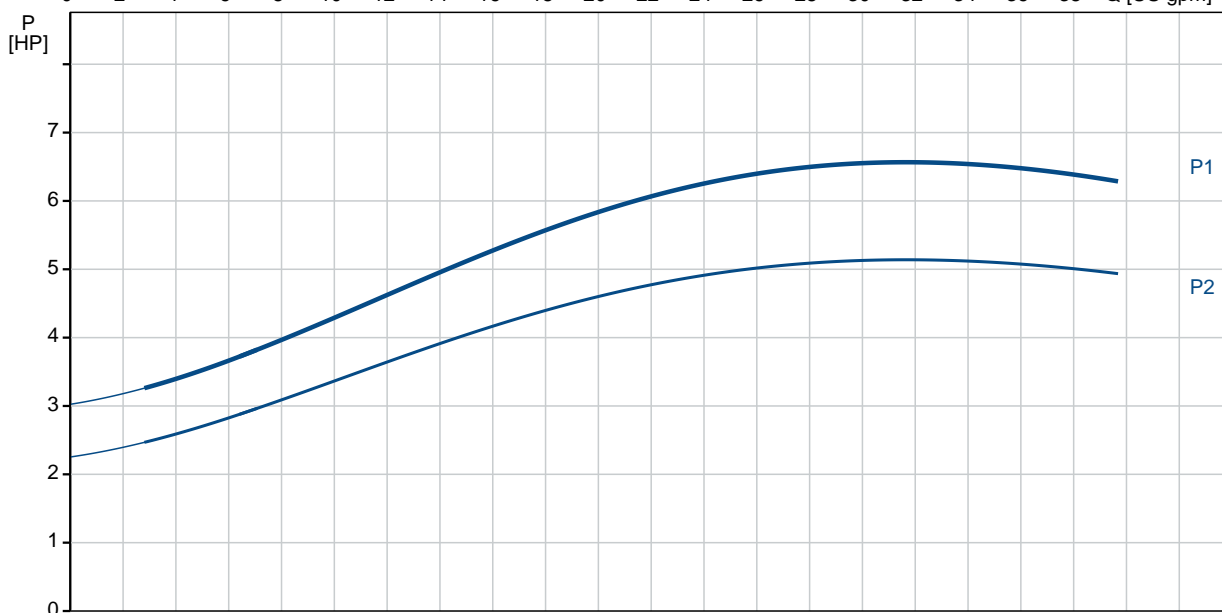
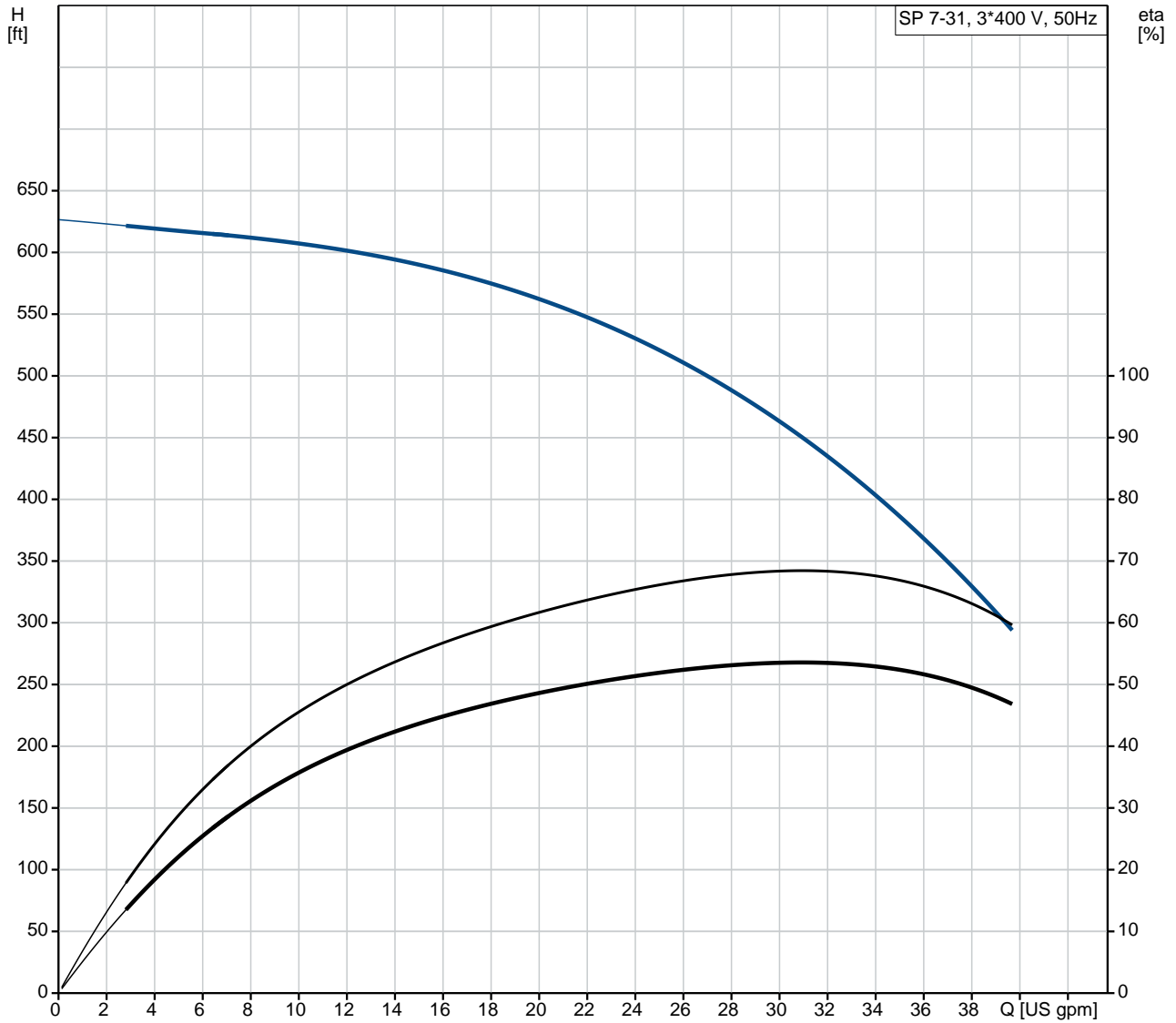

Description	Value
General information:	
Product name:	SP 7-31
Product No.:	98699184
EAN:	5712600108516
Technical:	
Pump speed on which pump data is based:	2900 rpm
Rated flow:	30.8 US gpm
Rated head:	467.5 ft
Stages:	31
Impeller reduc.:	NONE
Shaft seal for motor:	HM/CER
Approvals on nameplate:	CE,EAC
Curve tolerance:	ISO9906:2012 3B
Model:	A
Valve:	YES
Motor version:	T40
Materials:	
Pump:	Stainless steel EN 1.4301 AISI 304
Impeller:	Stainless steel EN 1.4301 AISI 304
Motor:	Stainless steel DIN W.-Nr. 1.4301 AISI 304
Installation:	
Pump outlet:	RP1 1/2
Motor diameter:	4 inch
Liquid:	
Pumped liquid:	Water
Maximum liquid temperature:	104 °F
Max liquid temperature at 0.15 m/sec:	104 °F
Selected liquid temperature:	68 °F
Density:	62.29 lb/ft³
Electrical data:	
Motor type:	MS4000
Applic. motor:	NEMA
Rated power - P2:	5.5 HP
Power (P2) required by pump:	5.5 HP
Main frequency:	50 Hz
Rated voltage:	3 x 380-400-415 V
Rated current:	9.75-9.60-9.80 A
Starting current:	460-500-530 %
Cos phi - power factor:	0.85-0.80-0.77
Rated speed:	2850-2865-2875 rpm
Start. method:	direct-on-line
Enclosure class (IEC 34-5):	IP68
Insulation class (IEC 85):	F
Motor protection:	NONE
Thermal protec:	external
Built-in temperature transmitter:	No
Motor Number:	79194510
Others:	
Minimum efficiency index, MEI :	0.70
ErP status:	EuP Standalone/Prod.
Net weight:	96.8 lb

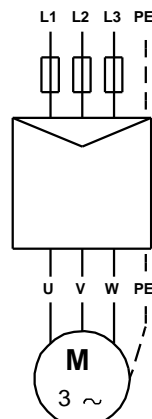
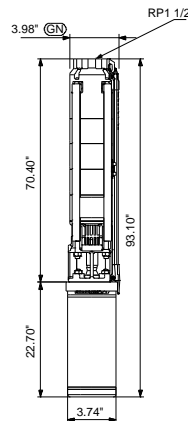
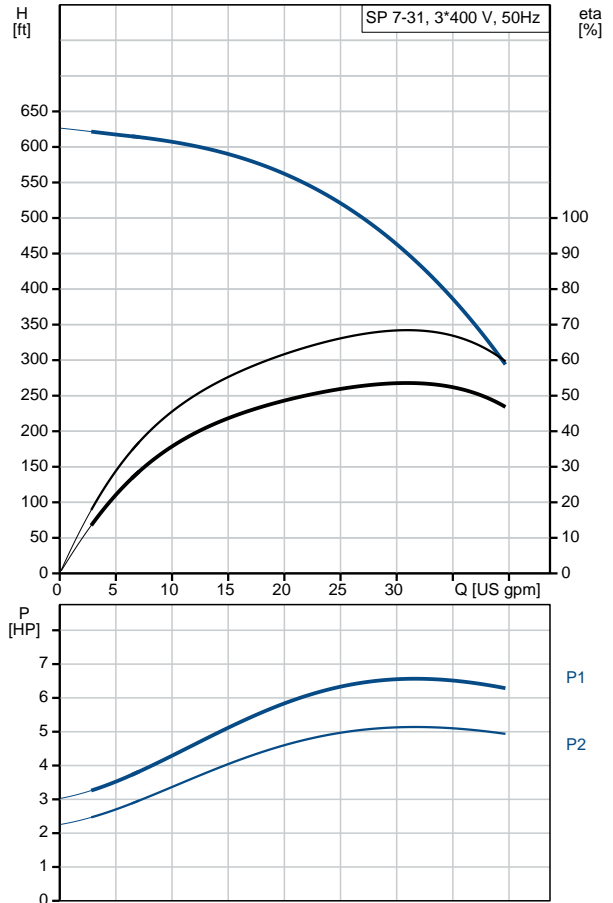



Company name:

Created by:

Phone:

Date: 6/13/2019

Description	Value
Gross weight:	175 lb
Shipping volume:	10.4 ft ³

98699184 SP 7-31 50 Hz

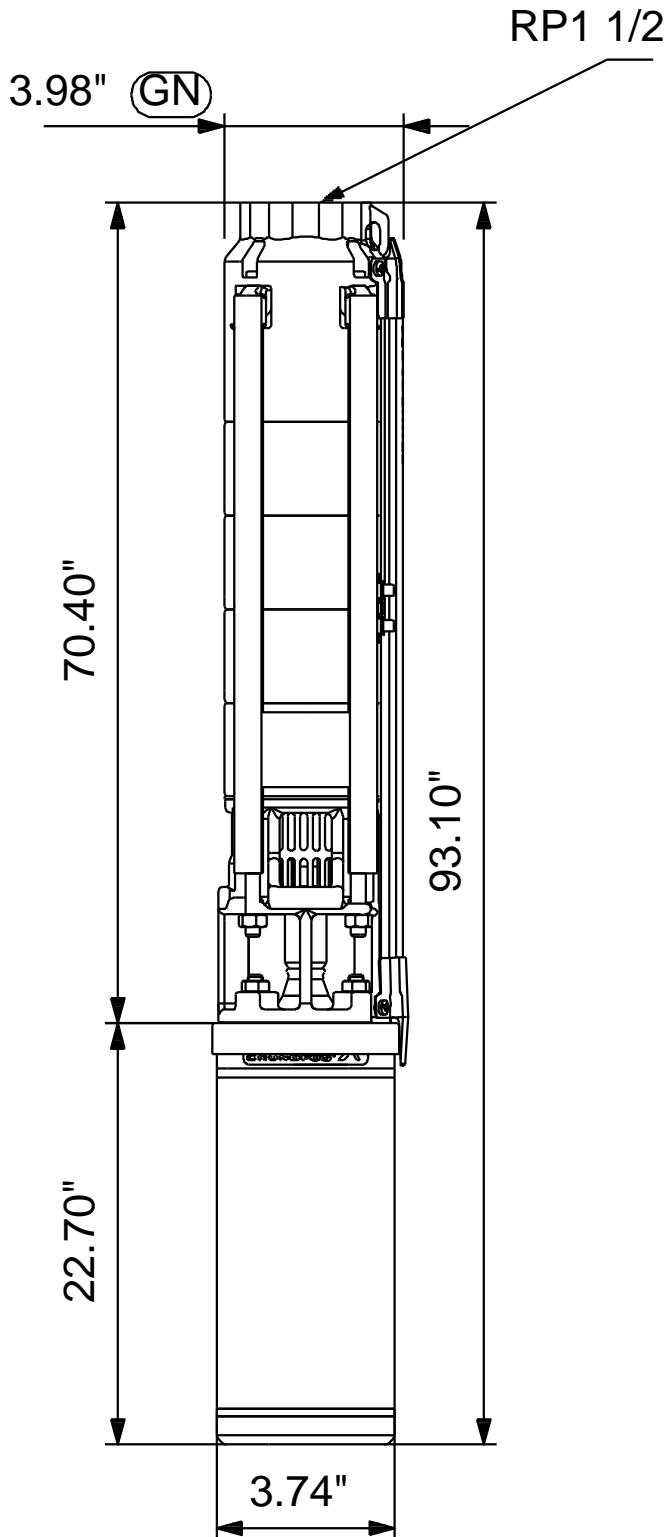

Note! All units are in [in] unless otherwise stated.
Disclaimer: This simplified dimensional drawing does not show all details.

98699184 SP 7-31 50 Hz



All units are [in] unless otherwise presented.



Company name:

Created by:

Phone:

Date:

6/13/2019

Order Data:

Product name: SP 7-31

Amount: 1

Product No.: 98699184

Total: Price on request
