

Count	Description
1	<p data-bbox="225 342 319 365"><b>SP 7-17</b></p> <div data-bbox="395 376 435 857" style="text-align: center;">  </div> <p data-bbox="619 835 1072 857" style="text-align: center;">Product photo could vary from the actual product</p> <p data-bbox="225 869 491 891">Product No.: <a href="#">98699181</a></p> <p data-bbox="225 898 834 1014">Multi-stage submersible pump for raw water supply, groundwater lowering and pressure boosting. The pump is suitable for pumping clean, thin, non-aggressive liquids without solid particles or fibers.</p> <p data-bbox="225 1048 770 1160">The pump is made entirely of Stainless steel DIN W.-Nr. EN 1.4301 and suitable for horizontal and vertical installation. The pump is fitted with a built-in non-return valve.</p> <p data-bbox="225 1193 770 1283">The motor is a 3-phase motor of the canned type with a sand shield, liquid-lubricated bearings and pressure-equalizing diaphragm.</p> <p data-bbox="225 1317 316 1339"><b>Liquid:</b></p> <p data-bbox="225 1346 738 1491">Pumped liquid: Water  Maximum liquid temperature: 104 °F  Max liquid temperature at 0.15 m/sec: 104 °F  Selected liquid temperature: 68 °F  Density: 62.29 lb/ft³</p> <p data-bbox="225 1525 352 1547"><b>Technical:</b></p> <p data-bbox="225 1554 826 1760">Pump speed on which pump data is based: 2900 rpm  Rated flow: 30.8 US gpm  Rated head: 255.3 ft  Shaft seal for motor: LIPSEAL  Approvals on nameplate: CE,EAC  Curve tolerance: ISO9906:2012 3B  Motor version: T40</p> <p data-bbox="225 1794 347 1816"><b>Materials:</b></p> <p data-bbox="225 1823 794 2085">Pump: Stainless steel  EN 1.4301  AISI 304  Impeller: Stainless steel  EN 1.4301  AISI 304  Motor: Stainless steel  DIN W.-Nr. 1.4301  AISI 304</p>

Count	Description
	<p><b>Installation:</b></p> <p>Pump outlet: RP1 1/2</p> <p>Motor diameter: 4 inch</p> <p><b>Electrical data:</b></p> <p>Motor type: MS402</p> <p>Rated power - P2: 3 HP</p> <p>Power (P2) required by pump: 3 HP</p> <p>Main frequency: 50 Hz</p> <p>Rated voltage: 3 x 380-400-415 V</p> <p>Rated current: 5.50-5.50-5.70 A</p> <p>Starting current: 440-460-470 %</p> <p>Cos phi - power factor: 0.85-0.82-0.77</p> <p>Rated speed: 2850-2860-2870 rpm</p> <p>Start. method: direct-on-line</p> <p>Enclosure class (IEC 34-5): IP68</p> <p>Insulation class (IEC 85): B</p> <p>Built-in temperature transmitter: No</p> <p>Motor Number: 79192007</p> <p><b>Others:</b></p> <p>Minimum efficiency index, MEI : 0.70</p> <p>ErP status: EuP Standalone/Prod.</p> <p>Net weight: 57.6 lb</p> <p>Gross weight: 63.1 lb</p> <p>Shipping volume: 0.74 ft<sup>3</sup></p> <p>Danish VVS No.: 388461017</p>

## 98699181 SP 7-17 50 Hz

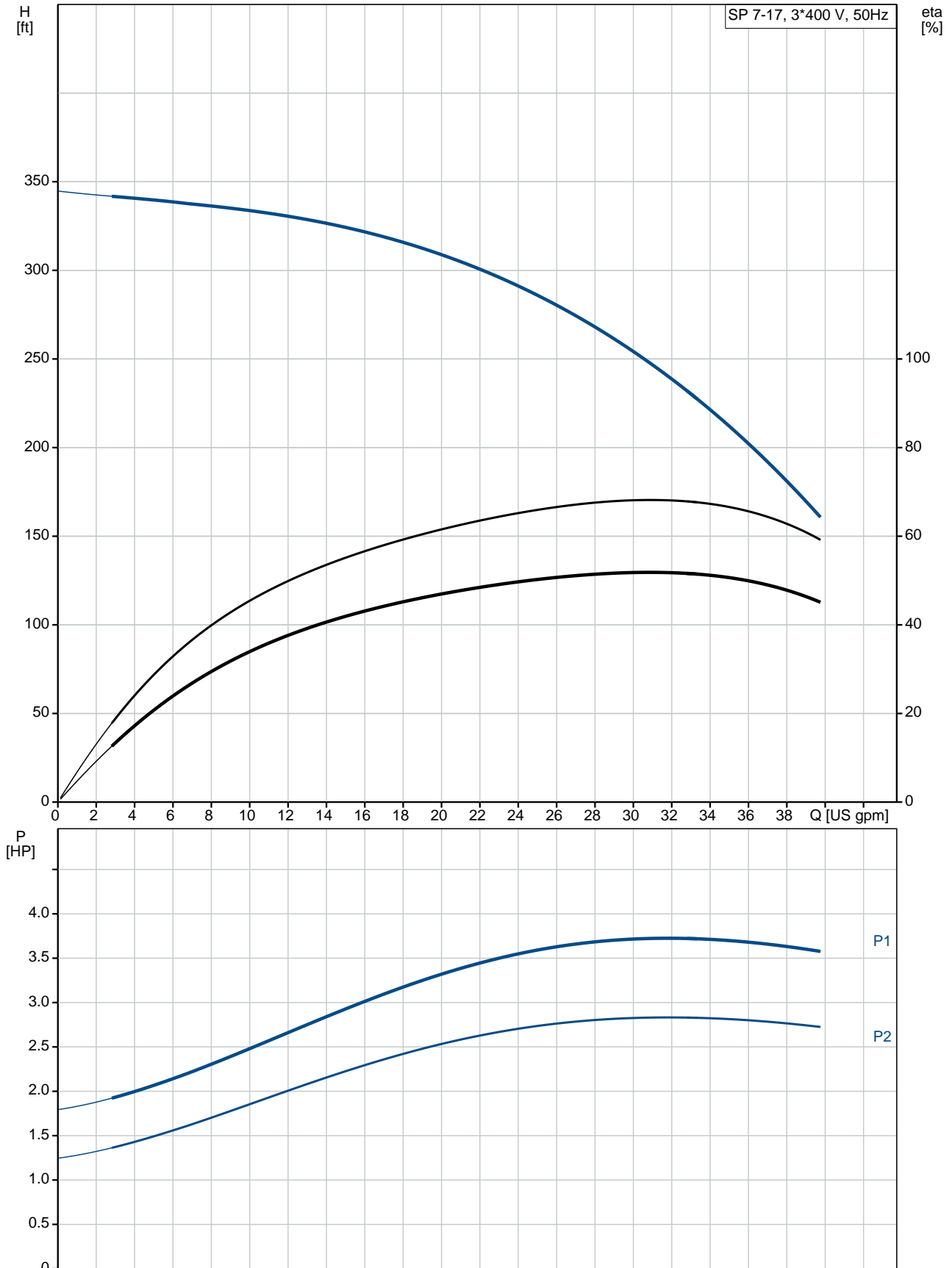

Description	Value
<b>General information:</b>	
Product name:	SP 7-17
Product No.:	98699181
EAN:	5712600108455
<b>Technical:</b>	
Pump speed on which pump data is based:	2900 rpm
Rated flow:	30.8 US gpm
Rated head:	255.3 ft
Stages:	17
Impeller reduc.:	NONE
Shaft seal for motor:	LIPSEAL
Approvals on nameplate:	CE,EAC
Curve tolerance:	ISO9906:2012 3B
Model:	A
Valve:	YES
Motor version:	T40
<b>Materials:</b>	
Pump:	Stainless steel EN 1.4301 AISI 304
Impeller:	Stainless steel EN 1.4301 AISI 304
Motor:	Stainless steel DIN W.-Nr. 1.4301 AISI 304
<b>Installation:</b>	
Pump outlet:	RP1 1/2
Motor diameter:	4 inch
<b>Liquid:</b>	
Pumped liquid:	Water
Maximum liquid temperature:	104 °F
Max liquid temperature at 0.15 m/sec:	104 °F
Selected liquid temperature:	68 °F
Density:	62.29 lb/ft³
<b>Electrical data:</b>	
Motor type:	MS402
Applic. motor:	NEMA
Rated power - P2:	3 HP
Power (P2) required by pump:	3 HP
Main frequency:	50 Hz
Rated voltage:	3 x 380-400-415 V
Rated current:	5.50-5.50-5.70 A
Starting current:	440-460-470 %
Cos phi - power factor:	0.85-0.82-0.77
Rated speed:	2850-2860-2870 rpm
Start. method:	direct-on-line
Enclosure class (IEC 34-5):	IP68
Insulation class (IEC 85):	B
Motor protection:	NONE
Thermal protec:	external
Built-in temperature transmitter:	No
Motor Number:	79192007
<b>Others:</b>	
Minimum efficiency index, MEI :	0.70
ErP status:	EuP Standalone/Prod.
Net weight:	57.6 lb

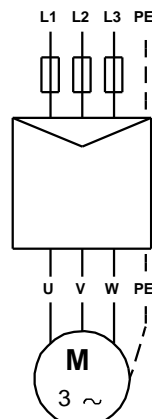
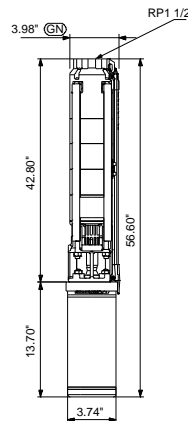
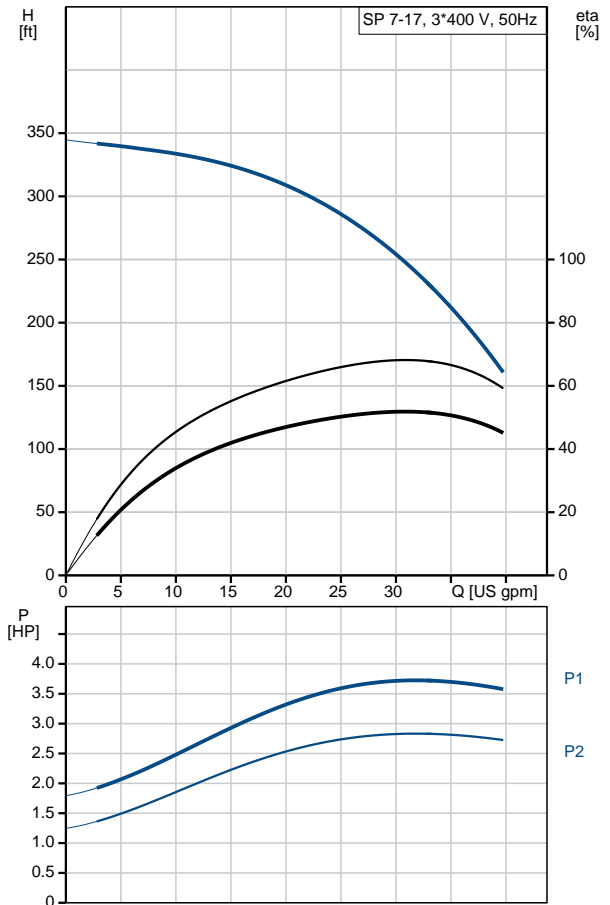



Company name:

Created by:

Phone:

Date:

6/12/2019

Description	Value
Gross weight:	63.1 lb
Shipping volume:	0.74 ft <sup>3</sup>
Danish VVS No.:	388461017

## 98699181 SP 7-17 50 Hz

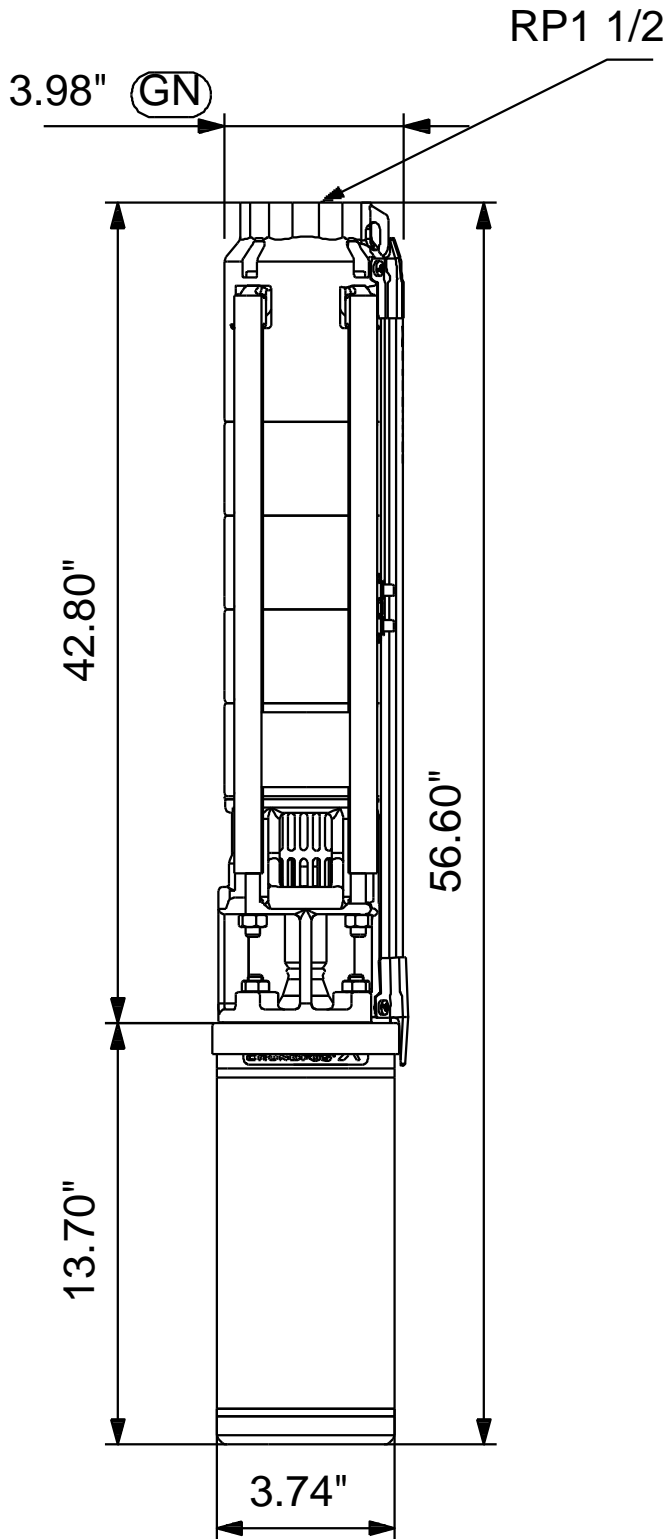

Note! All units are in [in] unless otherwise stated.  
Disclaimer: This simplified dimensional drawing does not show all details.

98699181 SP 7-17 50 Hz

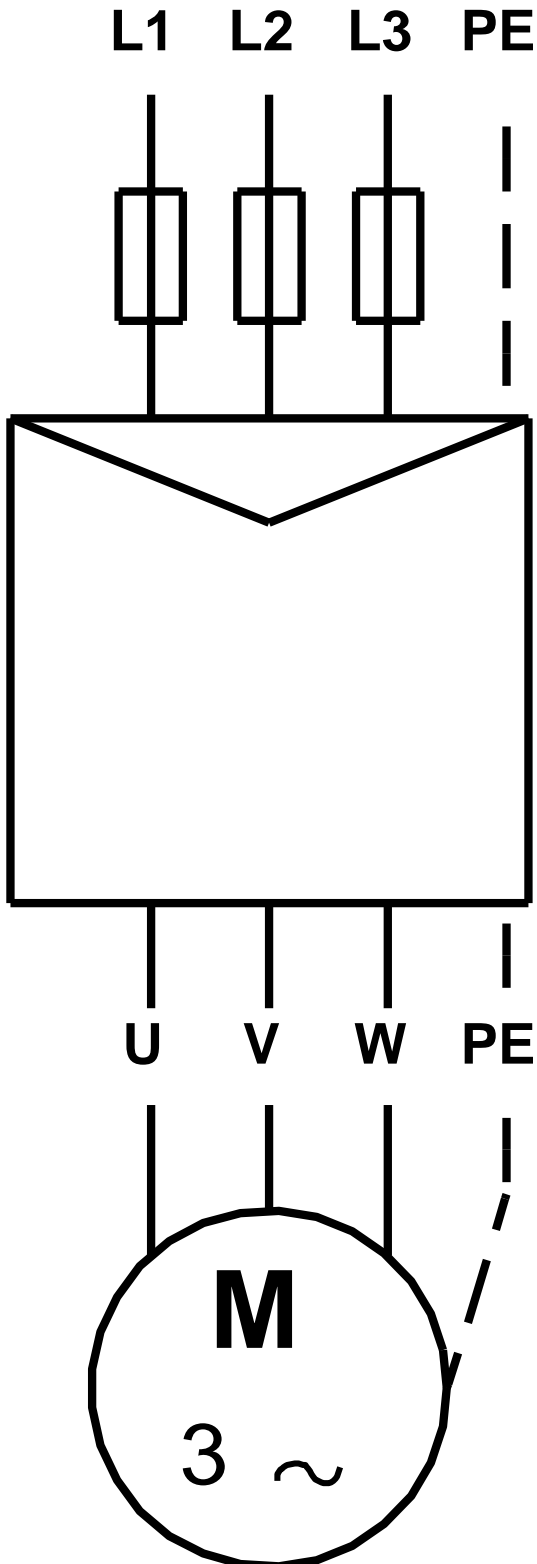

All units are [in] unless otherwise presented.



Company name:

Created by:

Phone:

Date: 6/12/2019

---

**Order Data:**

Product name: SP 7-17

Amount: 1

Product No.: 98699181

Total: Price on request

---