

Count	Description																														
1	<p data-bbox="225 338 304 367"><b>SP 7-3</b></p> <div data-bbox="395 376 435 860" style="text-align: center;">  </div> <p data-bbox="619 835 1070 860" style="text-align: center;">Product photo could vary from the actual product</p> <p data-bbox="225 869 491 896">Product No.: <a href="#">98699178</a></p> <p data-bbox="225 898 831 1014">Multi-stage submersible pump for raw water supply, groundwater lowering and pressure boosting. The pump is suitable for pumping clean, thin, non-aggressive liquids without solid particles or fibers.</p> <p data-bbox="225 1048 767 1164">The pump is made entirely of Stainless steel DIN W.-Nr. EN 1.4301 and suitable for horizontal and vertical installation. The pump is fitted with a built-in non-return valve.</p> <p data-bbox="225 1198 767 1283">The motor is a 3-phase motor of the canned type with a sand shield, liquid-lubricated bearings and pressure-equalizing diaphragm.</p> <p data-bbox="225 1317 312 1344"><b>Liquid:</b></p> <table data-bbox="225 1346 735 1491"> <tr> <td>Pumped liquid:</td> <td>Water</td> </tr> <tr> <td>Maximum liquid temperature:</td> <td>104 °F</td> </tr> <tr> <td>Max liquid temperature at 0.15 m/sec:</td> <td>104 °F</td> </tr> <tr> <td>Selected liquid temperature:</td> <td>68 °F</td> </tr> <tr> <td>Density:</td> <td>62.29 lb/ft<sup>3</sup></td> </tr> </table> <p data-bbox="225 1525 352 1552"><b>Technical:</b></p> <table data-bbox="225 1554 826 1760"> <tr> <td>Pump speed on which pump data is based:</td> <td>2900 rpm</td> </tr> <tr> <td>Rated flow:</td> <td>30.8 US gpm</td> </tr> <tr> <td>Rated head:</td> <td>42.65 ft</td> </tr> <tr> <td>Shaft seal for motor:</td> <td>LIPSEAL</td> </tr> <tr> <td>Approvals on nameplate:</td> <td>CE,EAC</td> </tr> <tr> <td>Curve tolerance:</td> <td>ISO9906:2012 3B</td> </tr> <tr> <td>Motor version:</td> <td>T40</td> </tr> </table> <p data-bbox="225 1794 344 1821"><b>Materials:</b></p> <table data-bbox="225 1823 794 2085"> <tr> <td>Pump:</td> <td>Stainless steel EN 1.4301 AISI 304</td> </tr> <tr> <td>Impeller:</td> <td>Stainless steel EN 1.4301 AISI 304</td> </tr> <tr> <td>Motor:</td> <td>Stainless steel DIN W.-Nr. 1.4301 AISI 304</td> </tr> </table>	Pumped liquid:	Water	Maximum liquid temperature:	104 °F	Max liquid temperature at 0.15 m/sec:	104 °F	Selected liquid temperature:	68 °F	Density:	62.29 lb/ft <sup>3</sup>	Pump speed on which pump data is based:	2900 rpm	Rated flow:	30.8 US gpm	Rated head:	42.65 ft	Shaft seal for motor:	LIPSEAL	Approvals on nameplate:	CE,EAC	Curve tolerance:	ISO9906:2012 3B	Motor version:	T40	Pump:	Stainless steel EN 1.4301 AISI 304	Impeller:	Stainless steel EN 1.4301 AISI 304	Motor:	Stainless steel DIN W.-Nr. 1.4301 AISI 304
Pumped liquid:	Water																														
Maximum liquid temperature:	104 °F																														
Max liquid temperature at 0.15 m/sec:	104 °F																														
Selected liquid temperature:	68 °F																														
Density:	62.29 lb/ft <sup>3</sup>																														
Pump speed on which pump data is based:	2900 rpm																														
Rated flow:	30.8 US gpm																														
Rated head:	42.65 ft																														
Shaft seal for motor:	LIPSEAL																														
Approvals on nameplate:	CE,EAC																														
Curve tolerance:	ISO9906:2012 3B																														
Motor version:	T40																														
Pump:	Stainless steel EN 1.4301 AISI 304																														
Impeller:	Stainless steel EN 1.4301 AISI 304																														
Motor:	Stainless steel DIN W.-Nr. 1.4301 AISI 304																														



Company name:

Created by:

Phone:

Date:

6/12/2019

Count	Description
	<b>Installation:</b>
	Pump outlet: RP1 1/2
	Motor diameter: 4 inch
	<b>Electrical data:</b>
	Motor type: MS402
	Rated power - P2: 0.75 HP
	Power (P2) required by pump: 0.75 HP
	Main frequency: 50 Hz
	Rated voltage: 3 x 380-400-415 V
	Rated current: 2.00-2.20-2.35 A
	Starting current: 470-480-470 %
	Cos phi - power factor: 0.70-0.64-0.60
	Rated speed: 2850-2860-2870 rpm
	Start. method: direct-on-line
	Enclosure class (IEC 34-5): IP68
	Insulation class (IEC 85): B
	Built-in temperature transmitter: No
	Motor Number: 79192003
	<b>Others:</b>
	Minimum efficiency index, MEI : 0.70
	ErP status: EuP Standalone/Prod.
	Net weight: 27.3 lb
	Gross weight: 30.6 lb
	Shipping volume: 0.39 ft <sup>3</sup>
	Danish VVS No.: 388461003

## 98699178 SP 7-3 50 Hz

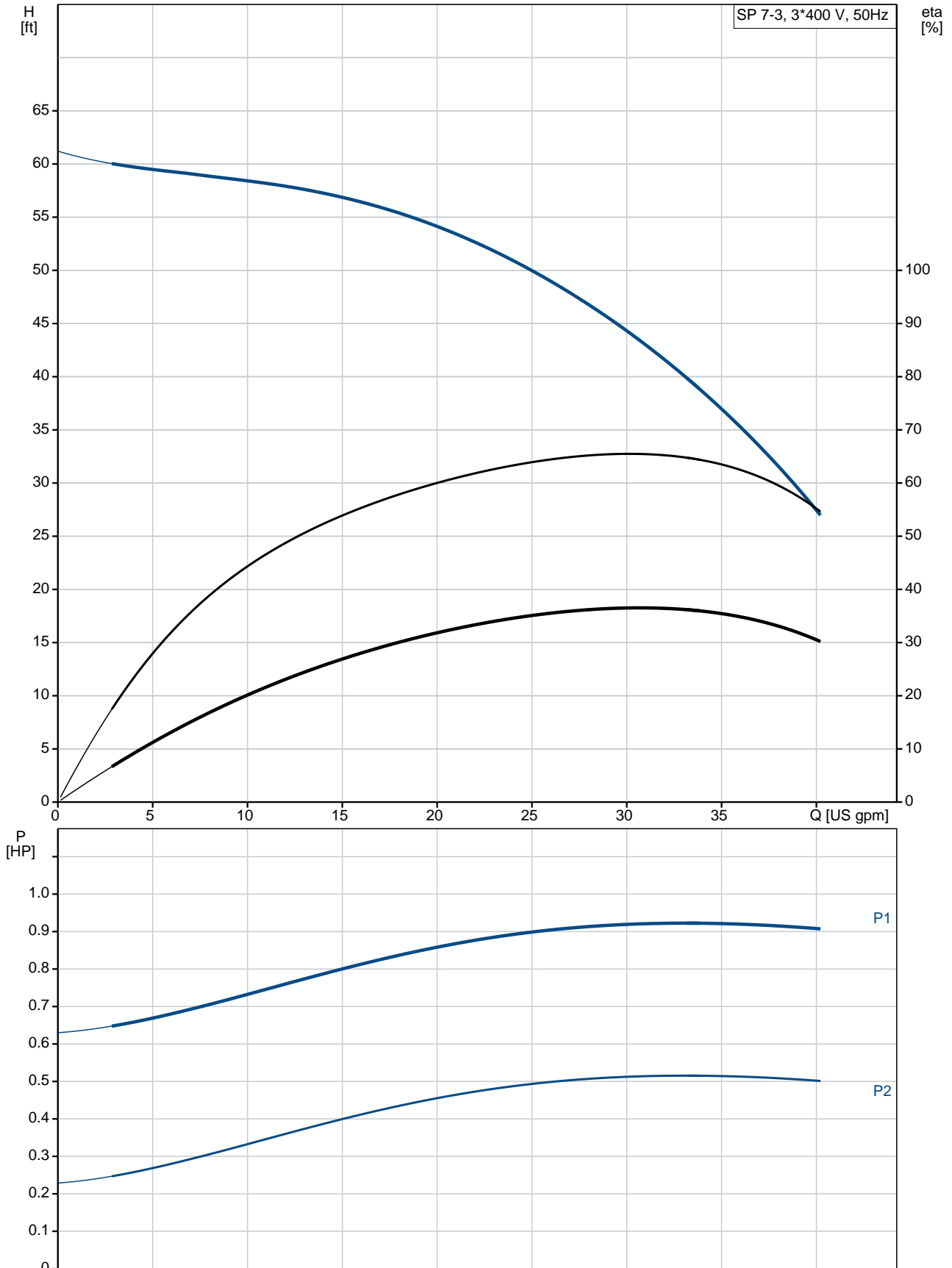

Description	Value
<b>General information:</b>	
Product name:	SP 7-3
Product No.:	98699178
EAN:	5712600108394
<b>Technical:</b>	
Pump speed on which pump data is based:	2900 rpm
Rated flow:	30.8 US gpm
Rated head:	42.65 ft
Stages:	3
Impeller reduc.:	NONE
Shaft seal for motor:	LIPSEAL
Approvals on nameplate:	CE,EAC
Curve tolerance:	ISO9906:2012 3B
Model:	A
Valve:	YES
Motor version:	T40
<b>Materials:</b>	
Pump:	Stainless steel EN 1.4301 AISI 304
Impeller:	Stainless steel EN 1.4301 AISI 304
Motor:	Stainless steel DIN W.-Nr. 1.4301 AISI 304
<b>Installation:</b>	
Pump outlet:	RP1 1/2
Motor diameter:	4 inch
<b>Liquid:</b>	
Pumped liquid:	Water
Maximum liquid temperature:	104 °F
Max liquid temperature at 0.15 m/sec:	104 °F
Selected liquid temperature:	68 °F
Density:	62.29 lb/ft³
<b>Electrical data:</b>	
Motor type:	MS402
Applic. motor:	NEMA
Rated power - P2:	0.75 HP
Power (P2) required by pump:	0.75 HP
Main frequency:	50 Hz
Rated voltage:	3 x 380-400-415 V
Rated current:	2.00-2.20-2.35 A
Starting current:	470-480-470 %
Cos phi - power factor:	0.70-0.64-0.60
Rated speed:	2850-2860-2870 rpm
Start. method:	direct-on-line
Enclosure class (IEC 34-5):	IP68
Insulation class (IEC 85):	B
Motor protection:	NONE
Thermal protec:	external
Built-in temperature transmitter:	No
Motor Number:	79192003
<b>Others:</b>	
Minimum efficiency index, MEI :	0.70
ErP status:	EuP Standalone/Prod.
Net weight:	27.3 lb

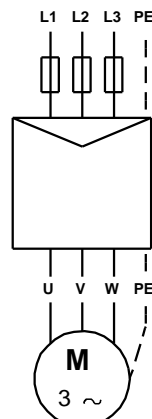
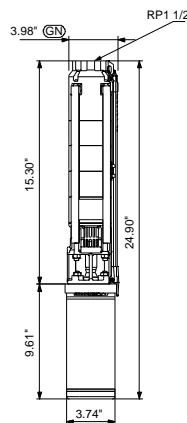
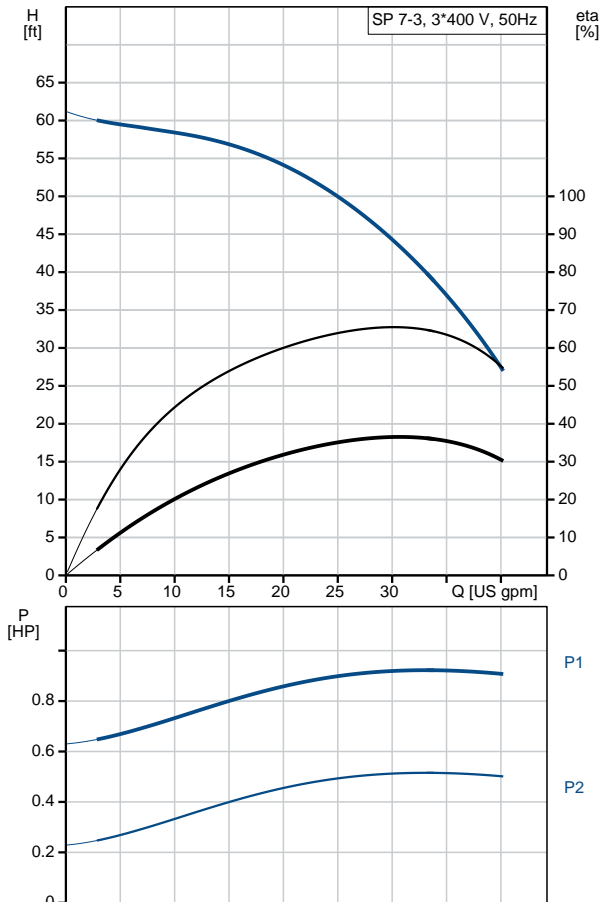



Company name:

Created by:

Phone:

Date:

6/12/2019

Description	Value
Gross weight:	30.6 lb
Shipping volume:	0.39 ft <sup>3</sup>
Danish VVS No.:	388461003

## 98699178 SP 7-3 50 Hz

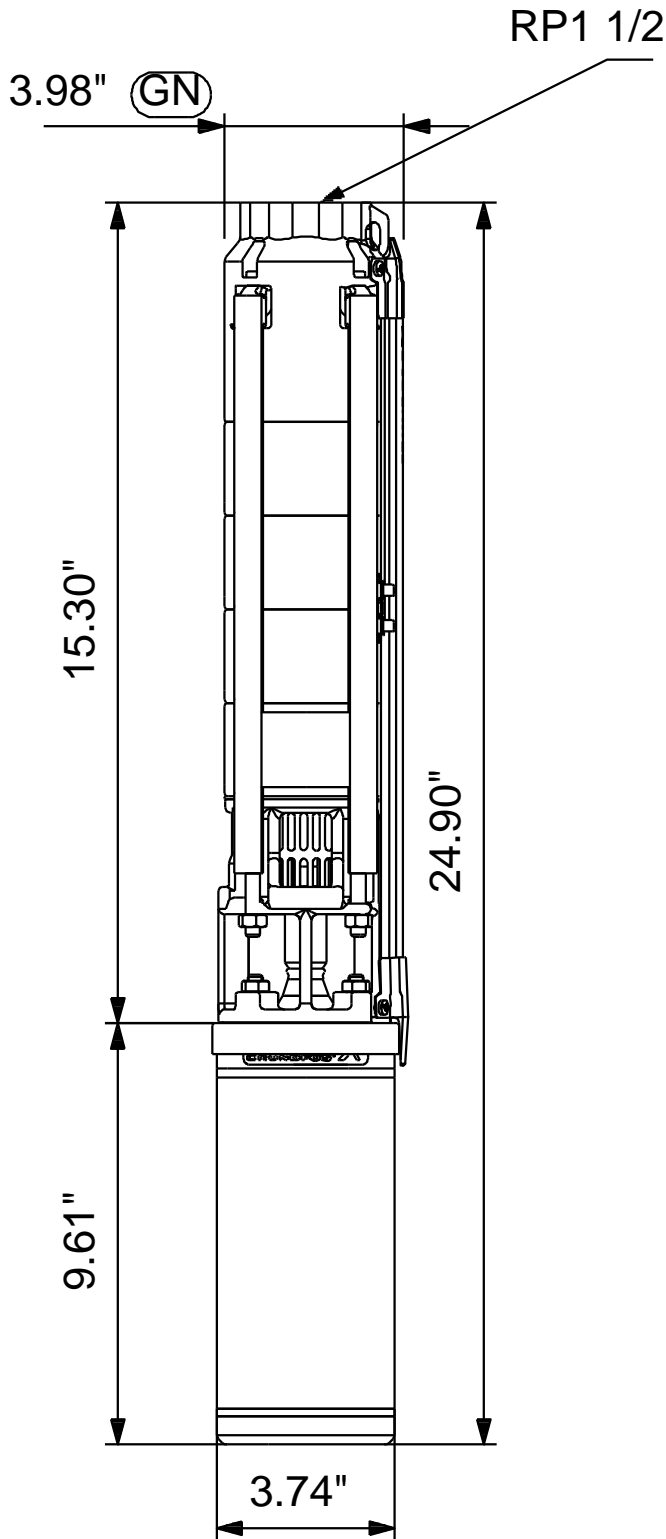

Note! All units are in [in] unless otherwise stated.  
Disclaimer: This simplified dimensional drawing does not show all details.

98699178 SP 7-3 50 Hz

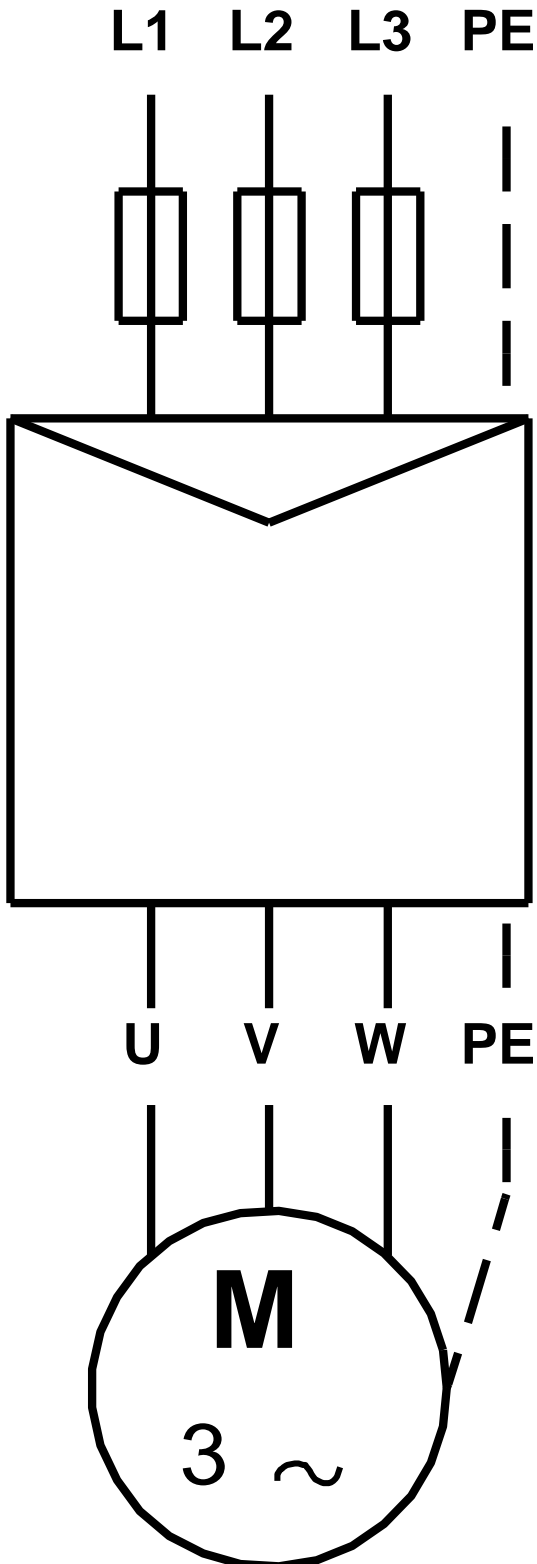

All units are [in] unless otherwise presented.



Company name:

Created by:

Phone:

Date: 6/12/2019

---

**Order Data:**

Product name: SP 7-3

Amount: 1

Product No.: 98699178

Total: Price on request

---