

Count	Description
1	<p data-bbox="225 338 319 367">SP 9-40</p>  <p data-bbox="619 837 1070 862">Product photo could vary from the actual product</p> <p data-bbox="225 869 491 896">Product No.: 98699065</p> <p data-bbox="225 898 831 1014">Multi-stage submersible pump for raw water supply, groundwater lowering and pressure boosting. The pump is suitable for pumping clean, thin, non-aggressive liquids without solid particles or fibers.</p> <p data-bbox="225 1048 767 1164">The pump is made entirely of Stainless steel DIN W.-Nr. EN 1.4301 and suitable for horizontal and vertical installation. The pump is fitted with a built-in non-return valve.</p> <p data-bbox="225 1198 767 1283">The motor is a 3-phase motor of the canned type with a sand shield, liquid-lubricated bearings and pressure-equalizing diaphragm.</p> <p data-bbox="225 1317 311 1344">Liquid:</p> <p data-bbox="225 1346 735 1491">Pumped liquid: Water Maximum liquid temperature: 104 °F Max liquid temperature at 0.15 m/sec: 104 °F Selected liquid temperature: 68 °F Density: 62.29 lb/ft³</p> <p data-bbox="225 1525 347 1552">Technical:</p> <p data-bbox="225 1554 826 1760">Pump speed on which pump data is based: 2900 rpm Rated flow: 39.6 US gpm Rated head: 695.6 ft Shaft seal for motor: HM/CER Approvals on nameplate: CE,EAC Curve tolerance: ISO9906:2012 3B Motor version: T40</p> <p data-bbox="225 1794 343 1821">Materials:</p> <p data-bbox="225 1823 794 2085">Pump: Stainless steel EN 1.4301 AISI 304 Impeller: Stainless steel EN 1.4301 AISI 304 Motor: Stainless steel DIN W.-Nr. 1.4301 AISI 304</p>

Count	Description
	<p>Installation:</p> <p>Pump outlet: RP2</p> <p>Motor diameter: 4 inch</p> <p>Electrical data:</p> <p>Motor type: MS4000</p> <p>Rated power - P2: 10 HP</p> <p>Power (P2) required by pump: 10 HP</p> <p>Main frequency: 50 Hz</p> <p>Rated voltage: 3 x 380-400-415 V</p> <p>Rated current: 18.4-18.8-19.6 A</p> <p>Starting current: 490-530-550 %</p> <p>Cos phi - power factor: 0.83-0.78-0.72</p> <p>Rated speed: 2830-2850-2870 rpm</p> <p>Start. method: direct-on-line</p> <p>Enclosure class (IEC 34-5): IP68</p> <p>Insulation class (IEC 85): F</p> <p>Built-in temperature transmitter: yes</p> <p>Motor Number: 79195512</p> <p>Others:</p> <p>Minimum efficiency index, MEI : 0.70</p> <p>ErP status: EuP Standalone/Prod.</p> <p>Net weight: 130 lb</p> <p>Gross weight: 222 lb</p> <p>Shipping volume: 13 ft³</p> <p>Danish VVS No.: 388480040</p>

98699065 SP 9-40 50 Hz

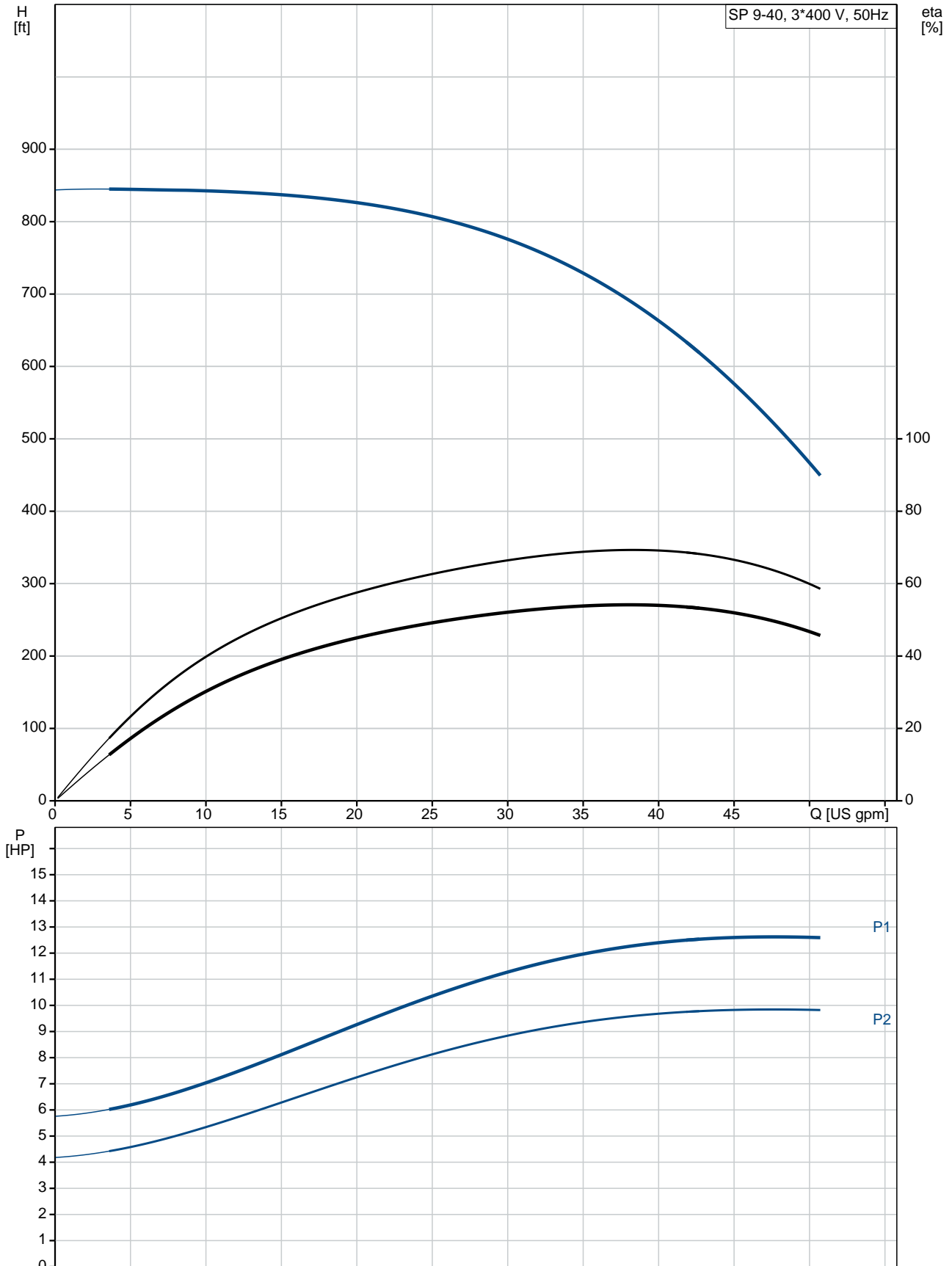

Description	Value
General information:	
Product name:	SP 9-40
Product No.:	98699065
EAN:	5712600106130
Technical:	
Pump speed on which pump data is based:	2900 rpm
Rated flow:	39.6 US gpm
Rated head:	695.6 ft
Stages:	40
Impeller reduc.:	NONE
Shaft seal for motor:	HM/CER
Approvals on nameplate:	CE,EAC
Curve tolerance:	ISO9906:2012 3B
Model:	A
Valve:	YES
Motor version:	T40
Materials:	
Pump:	Stainless steel EN 1.4301 AISI 304
Impeller:	Stainless steel EN 1.4301 AISI 304
Motor:	Stainless steel DIN W.-Nr. 1.4301 AISI 304
Installation:	
Pump outlet:	RP2
Motor diameter:	4 inch
Liquid:	
Pumped liquid:	Water
Maximum liquid temperature:	104 °F
Max liquid temperature at 0.15 m/sec:	104 °F
Selected liquid temperature:	68 °F
Density:	62.29 lb/ft³
Electrical data:	
Motor type:	MS4000
Applic. motor:	NEMA
Rated power - P2:	10 HP
Power (P2) required by pump:	10 HP
Main frequency:	50 Hz
Rated voltage:	3 x 380-400-415 V
Rated current:	18.4-18.8-19.6 A
Starting current:	490-530-550 %
Cos phi - power factor:	0.83-0.78-0.72
Rated speed:	2830-2850-2870 rpm
Start. method:	direct-on-line
Enclosure class (IEC 34-5):	IP68
Insulation class (IEC 85):	F
Motor protection:	NONE
Thermal protec:	external
Built-in temperature transmitter:	yes
Motor Number:	79195512
Others:	
Minimum efficiency index, MEI :	0.70
ErP status:	EuP Standalone/Prod.
Net weight:	130 lb

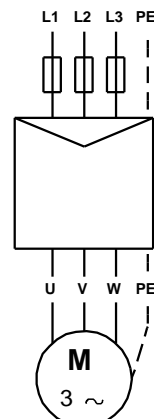
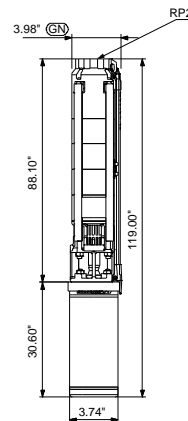
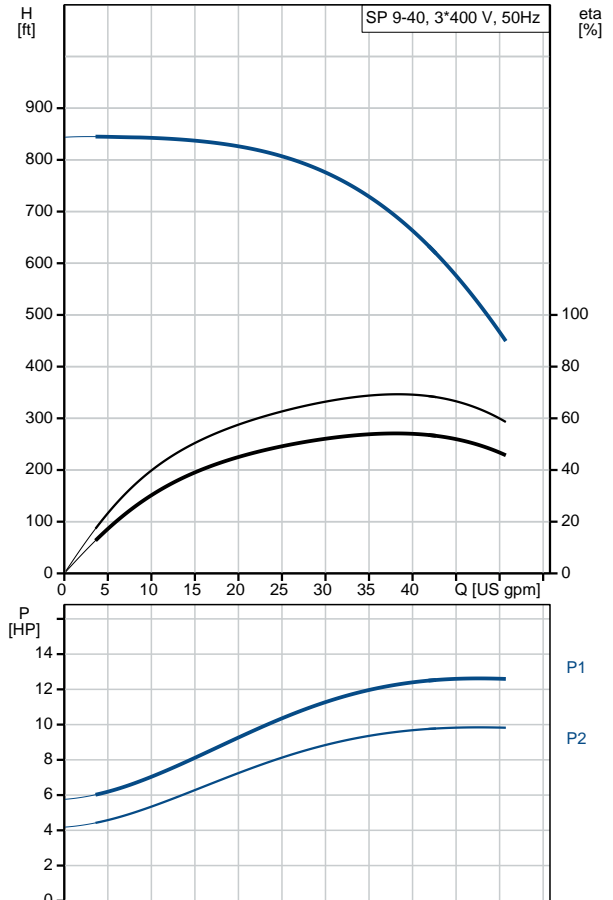



Company name:

Created by:

Phone:

Date:

6/14/2019

Description	Value
Gross weight:	222 lb
Shipping volume:	13 ft ³
Danish VVS No.:	388480040

98699065 SP 9-40 50 Hz

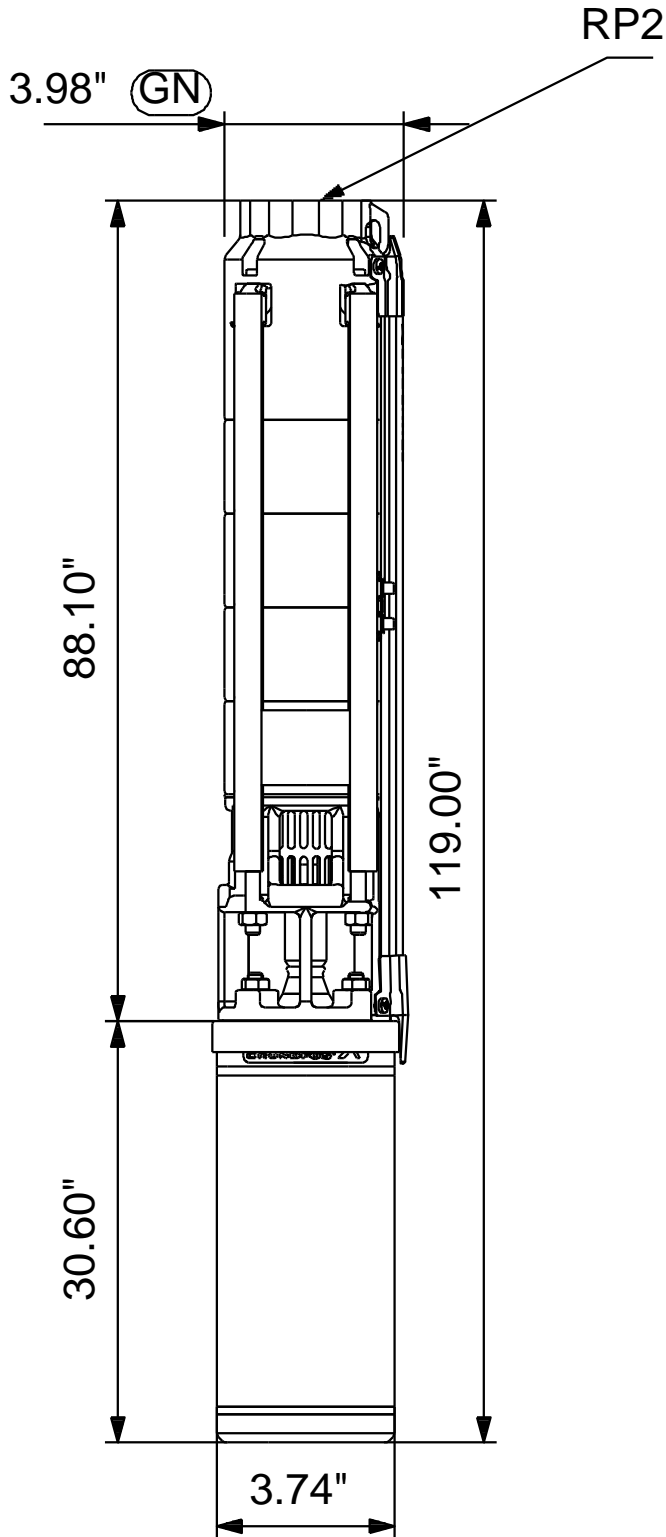

Note! All units are in [in] unless otherwise stated.
Disclaimer: This simplified dimensional drawing does not show all details.

98699065 SP 9-40 50 Hz

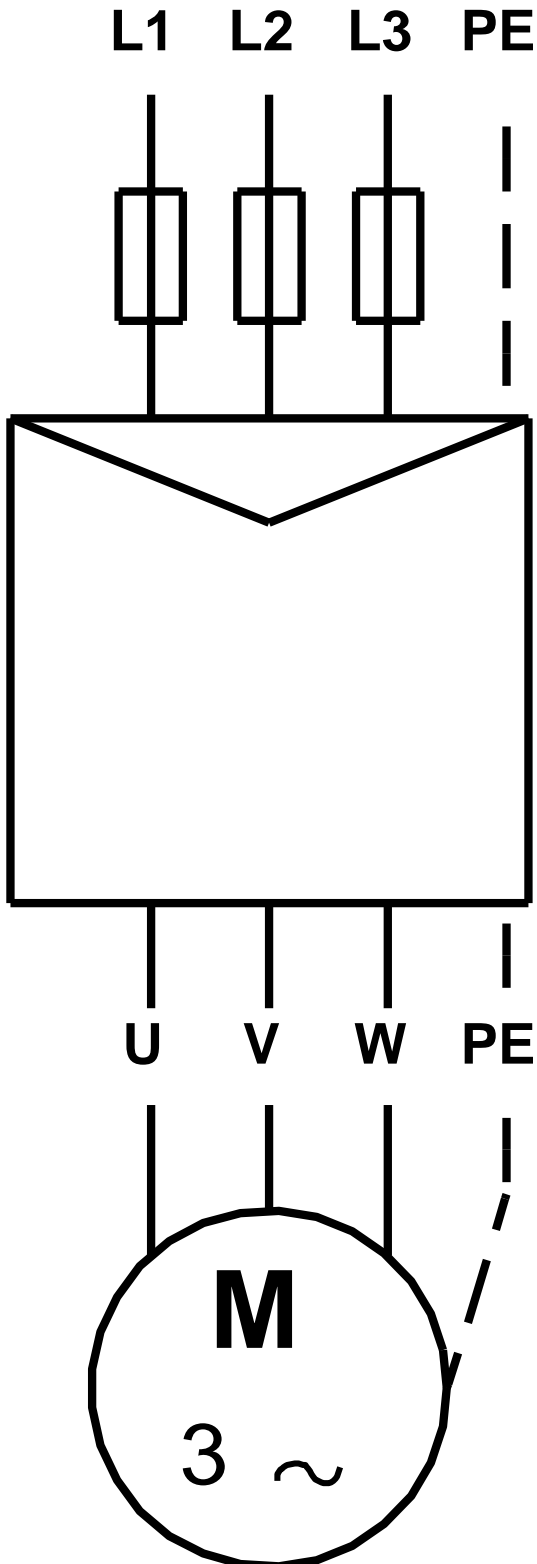

All units are [in] unless otherwise presented.



Company name:

Created by:

Phone:

Date: 6/14/2019

Order Data:

Product name: SP 9-40

Amount: 1

Product No.: 98699065

Total: Price on request
