

Position	Qty.	Description
	1	<p data-bbox="320 338 655 365"><b>HYDRO MULTI-E 3 CRIE3-08</b></p> <div data-bbox="379 409 635 611" style="text-align: center;">  </div> <p data-bbox="711 611 1193 638" style="text-align: center;"><b>Note! Product picture may differ from actual product</b></p> <p data-bbox="320 642 584 669">Product No.: <a href="#">98486676</a></p> <p data-bbox="320 701 1449 754">GRUNDFOS Hydro Multi-E booster sets are designed for the transfer and pressure boosting of clean water in waterworks, blocks of flats, hotels, industry, hospitals, schools, etc.</p> <p data-bbox="320 759 1449 813">GRUNDFOS Hydro Multi-E booster set consists of 2 to 4 CRIE pumps coupled in parallel and mounted on a common base frame provided with all the necessary fittings.</p> <p data-bbox="320 844 1449 1001">Hydro Multi-E is mounted on a common base frame made of stainless steel (DIN W.-Nr. 1.4301). On the suction side are fitted a suction manifold (DIN W.-Nr. 1.4401 or DIN W.-Nr. 1.4571) , a pressure switch mounted on a drainable valve and an isolating valve. On the discharge side of the pumps are fitted a non-return valve, an isolating valve, a pressure gauge, two pressure transmitters mounted on a drainable valve a diaphragm tank and a stainless steel discharge manifold (DIN W.-Nr. 1.4401 or DIN W.-Nr. 1.4571).</p> <p data-bbox="320 1016 1086 1043">The Hydro Multi-E is fitted with an on/off-switch for the supply voltage.</p> <p data-bbox="320 1075 1398 1128">The Hydro Multi-E is designed for maintaining a constant pressure regardless of flow changes and fluctuation.</p> <p data-bbox="320 1164 1345 1218">The internal PI-controller regulates the number of running pumps and the speed of the pumps according to the required flow.</p> <p data-bbox="320 1252 1457 1305">The system can be operated directly on the panel of any of the pumps or via Grundfos GO (available as accessory)</p> <p data-bbox="320 1339 979 1606">Besides the system features:  2 Digital outputs  2 Digital inputs (one used for dry run protection)  2 Analogue inputs (one used for discharge pressure sensor)  Multi-Master functionality  2 Limit functions  Set-point influence function  Pipe filling function  High efficient PM motors</p> <p data-bbox="320 1637 708 1664">Available communication protocols:</p> <ul data-bbox="320 1668 523 1935" style="list-style-type: none"> <li>•LON</li> <li>•Profibus</li> <li>•Modbus</li> <li>•SMS/GSM/GPRS</li> <li>•GRM</li> <li>•BACnet</li> <li>•BACnet IP</li> <li>•Modbus TCP</li> <li>•PROFINET</li> </ul> <p data-bbox="320 1968 1426 1995">When delivered, the GRUNDFOS Hydro Multi-E booster set is factory tested and ready for operation.</p> <p data-bbox="320 2058 403 2085"><b>Liquid:</b></p>

Position	Qty.	Description
		<p>Pumped liquid: Water            Liquid temperature range: 5 .. 60 °C            Liquid temperature during operation: 20 °C            Density: 998.2 kg/m<sup>3</sup></p> <p><b>Materials:</b>            Pump housing: Stainless steel</p> <p><b>Installation:</b>            Maximum operating pressure: 10 bar            Maximum inlet pressure: PN 10 bar            Flange standard: DIN ISO 7/1            Manifold inlet: R 2            Manifold outlet: R 2</p> <p><b>Electrical data:</b>            IE Efficiency class: IE5            Power (P2) main pump: 1.1 kW            Mains frequency: 50 Hz            Rated voltage: 3 x 380-415 V            Phase main pump: 1            Rated current: 10.2 A            Start. method: electronically            Enclosure class (IEC 34-5): IP54</p> <p><b>Tank:</b>            Volume of pressure tank: 8 l            Diaphragm tank: Yes</p> <p><b>Others:</b>            Net weight: 110 kg            Gross weight: 140 kg            Shipping volume: 0.429 m<sup>3</sup>            Language: GB            Country of origin: DE            Custom tariff no.: 84137075</p>

## 98486676 HYDRO MULTI-E 3 CRIE3-08 50 Hz

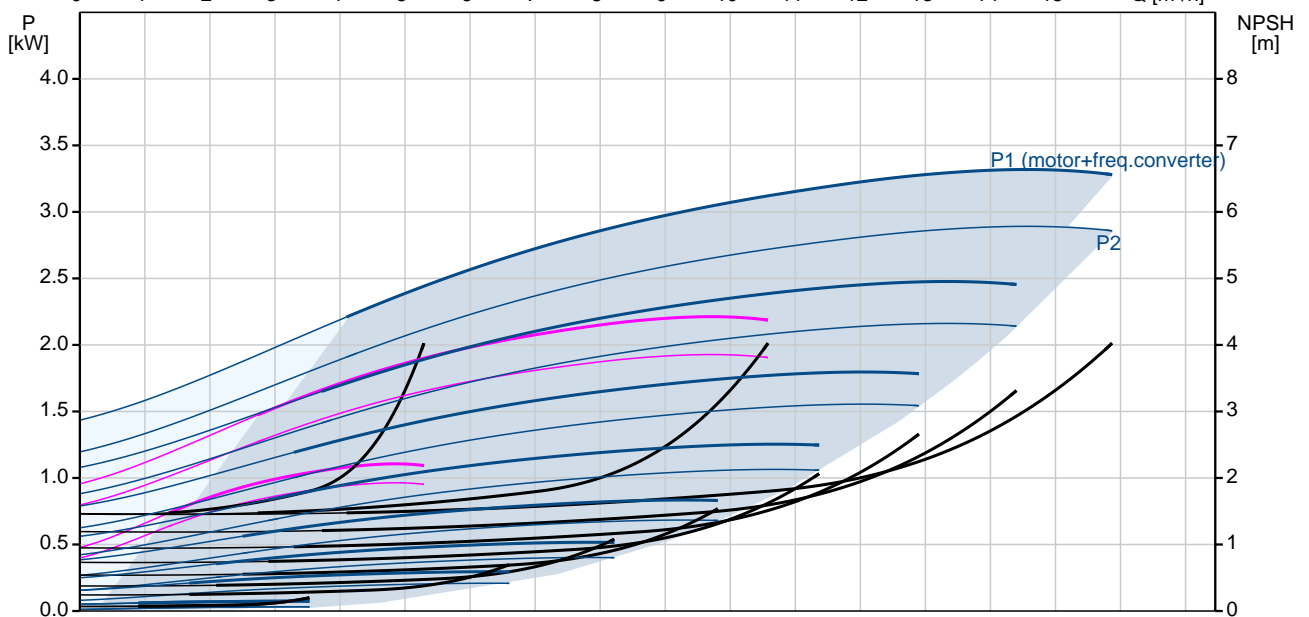
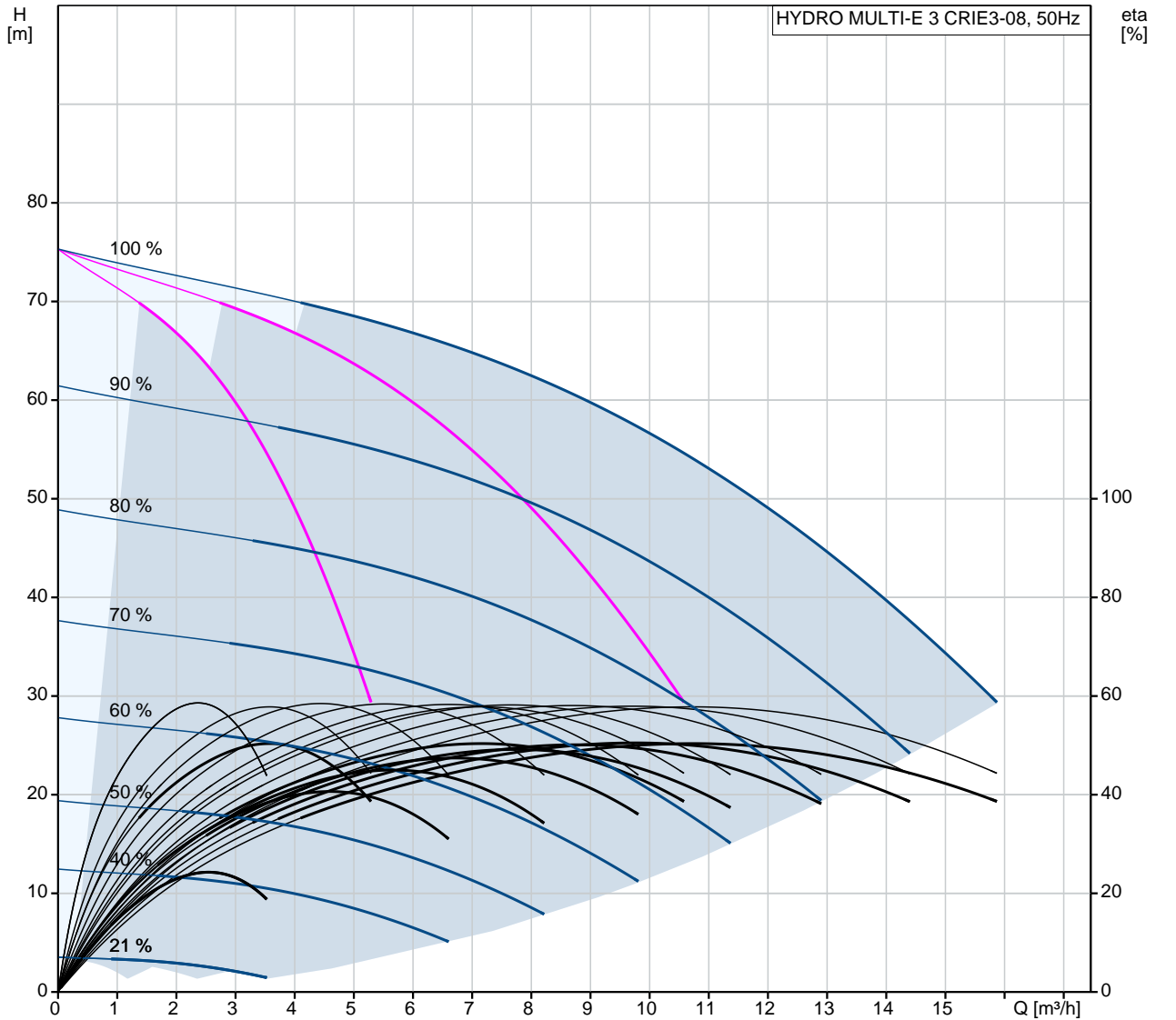

Description	Value
<b>General information:</b>	
Product name:	HYDRO MULTI-E 3 CRIE3-08
Product No:	98486676
EAN number:	5711495953430
Price:	8.958,00 GBP
<b>Technical:</b>	
Min flow system:	0.35 m <sup>3</sup> /h
Max flow:	16.2 m <sup>3</sup> /h
Head max:	74 m
Pump name:	CRIE3-08
Number of pumps:	3
<b>Materials:</b>	
Pump housing:	Stainless steel
Manifolds:	Stainless steel
<b>Installation:</b>	
Maximum operating pressure:	10 bar
Maximum inlet pressure:	PN 10 bar
Flange standard:	DIN ISO 7/1
Manifold inlet:	R 2
Manifold outlet:	R 2
<b>Liquid:</b>	
Pumped liquid:	Water
Liquid temperature range:	5 .. 60 °C
Liquid temperature during operation:	20 °C
Density:	998.2 kg/m <sup>3</sup>
<b>Electrical data:</b>	
IE Efficiency class:	IE5
Power (P2) main pump:	1.1 kW
Mains frequency:	50 Hz
Rated voltage:	3 x 380-415 V
Phase main pump:	1
Rated current:	10.2 A
Start. method:	electronically
Enclosure class (IEC 34-5):	IP54
<b>Tank:</b>	
Volume of pressure tank:	8 l
Diaphragm tank:	Yes
<b>Others:</b>	
Net weight:	110 kg
Gross weight:	140 kg
Shipping volume:	0.429 m <sup>3</sup>
Language:	GB
Product range:	International
Country of origin:	DE
Custom tariff no.:	84137075

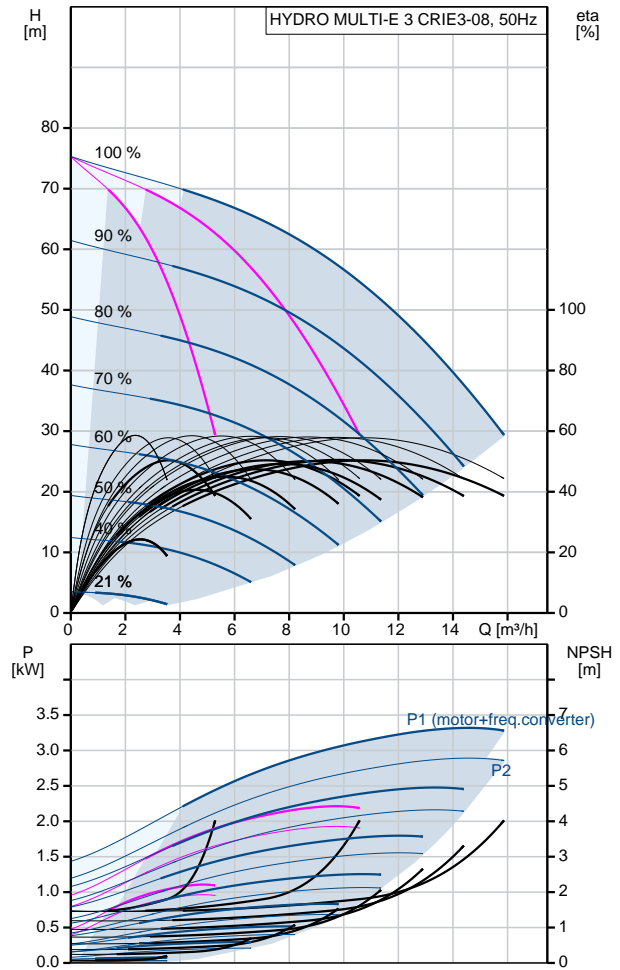

## 98486676 HYDRO MULTI-E 3 CRIE3-08 50 Hz

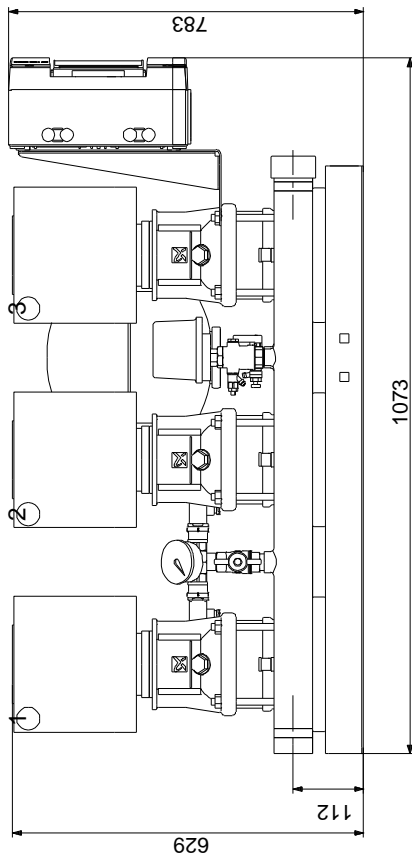
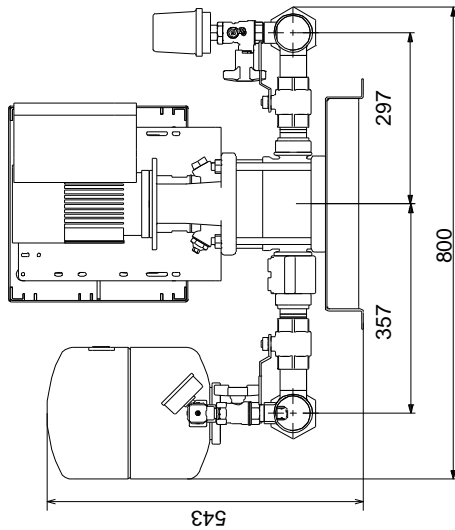

Note! All units are in [mm] unless others are stated.  
Disclaimer: This simplified dimensional drawing does not show all details.

## 98486676 HYDRO MULTI-E 3 CRIE3-08 50 Hz

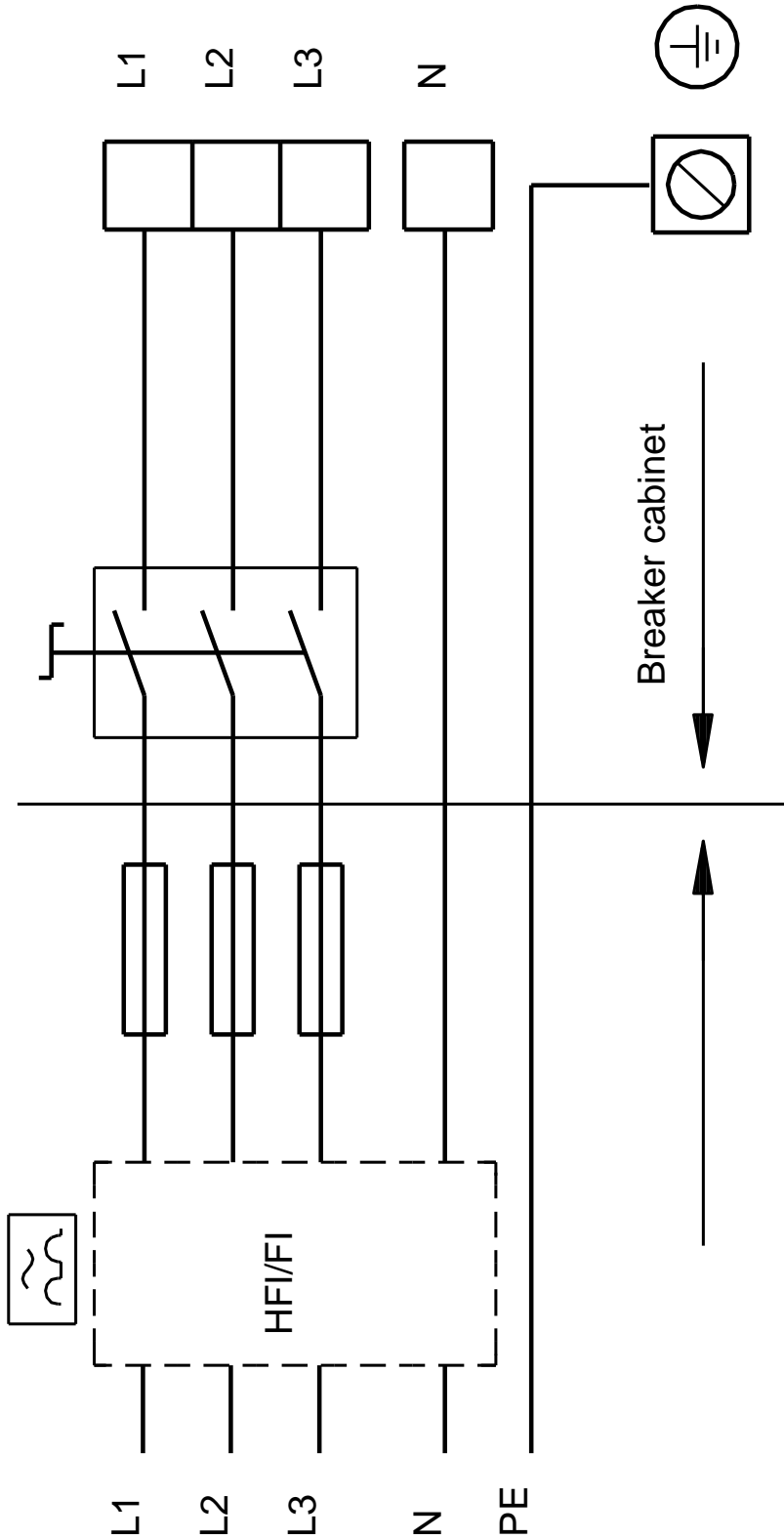

Note! All units are in [mm] unless others are stated.