

Qty. Description

1 TPE2 D 40-80-N A-F-A-BQQE



Note! Product picture may differ from actual product

Product No.: [98438130](#)

Single-stage, close-coupled, volute twin-head pump with in-line suction and discharge ports of identical diameter. The twin-head pump is designed with two parallel power-heads. The pump is of the top-pull-out design, i.e. the power head (motor, pump head and impeller) can be removed for maintenance or service while the pump housing remains in the pipework.

Each power head is fitted with an unbalanced rubber bellows seal. The shaft seal is according to EN 12756. Pipework connection is via PN 6/10 DIN flanges (EN 1092-2 and ISO 7005-2).

Pipework connection is via PN 6/10 DIN flanges (EN 1092-2 and ISO 7005-2).

Each power head is fitted with a fan-cooled, permanent-magnet synchronous motor of identical size. The motor efficiency is classified as IE5 in accordance with IEC 60034-30-2.

The motor includes a frequency converter and PI controller in the motor terminal box. This enables continuously variable control of the motor speed, which again enables adaptation of the performance to a given requirement.

Controls:

Frequency converter: Built-in

Liquid:

Pumped liquid: Water
 Liquid temperature range: -25 .. 120 °C
 Selected liquid temperature: 20 °C
 Density at selected liquid temperature: 998.2 kg/m³

Technical:

Pump speed on which pump data are based: 2970 rpm
 Rated flow: 11.1 m³/h
 Rated head: 5.8 m
 Actual impeller diameter: 74 mm
 Primary shaft seal: BQQE
 Curve tolerance: ISO9906:2012 3B2

Materials:

Pump housing: Cast iron
 EN-JL1040
 ASTM A48-40 B
 Impeller: Composite PES/PP 30% GF

Installation:

Range of ambient temperature: -20 .. 50 °C
 Maximum operating pressure: 10 bar
 Flange standard: DIN
 Pipe connection: DN 40

Qty.	Description
------	-------------

Pressure rating:	PN 6/10
Port-to-port length:	311 mm
Flange size for motor:	56C

Electrical data:

Motor type:	71A
IE Efficiency class:	IE5
Rated power - P2:	2 x 0.25 kW
Mains frequency:	50 / 60 Hz
Rated voltage:	3 x 380-500 V
Rated current:	0.90-0.75 A
Cos phi - power factor:	0.58-0.50
Rated speed:	360-4000 rpm
Efficiency:	81.2%
Motor efficiency at full load:	81.2 %
Enclosure class (IEC 34-5):	IP55
Insulation class (IEC 85):	F
Motor No:	99138013

Others:

Minimum efficiency index, MEI	: 0.7
ErP status:	EuP Standalone/Prod.
Net weight:	48.4 kg
Gross weight:	61.7 kg
Shipping volume:	0.246 m ³
Country of origin:	HU
Custom tariff no.:	84137065

98438130 TPE2 D 40-80-N A-F-A-BQQE

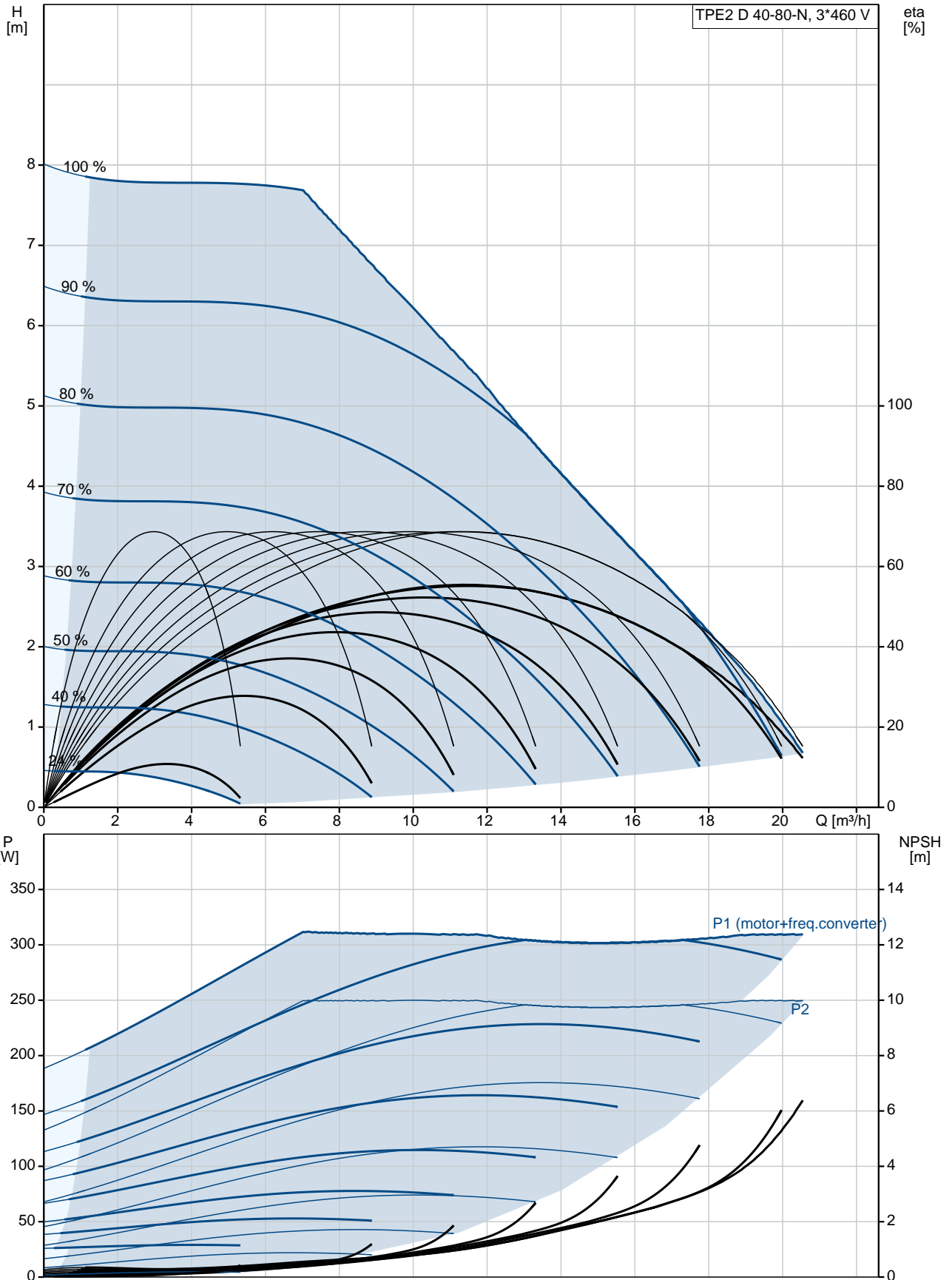

Description	Value
General information:	
Product name:	TPE2 D 40-80-N A-F-A-BQQE
Product No:	98438130
EAN number:	5711495014797
Price:	5711495014797
	4.101,00 GBP
Technical:	
Pump speed on which pump data are based:	2970 rpm
Rated flow:	11.1 m ³ /h
Rated head:	5.8 m
Head max:	80 dm
Actual impeller diameter:	74 mm
Primary shaft seal:	BQQE
Curve tolerance:	ISO9906:2012 3B2
Pump version:	A
Model:	A
Materials:	
Pump housing:	Cast iron
	EN-JL1040
	ASTM A48-40 B
Impeller:	Composite PES/PP 30% GF
Material code:	A
Installation:	
Range of ambient temperature:	-20 .. 50 °C
Maximum operating pressure:	10 bar
Flange standard:	DIN
Pipe connection:	DN 40
Pressure rating:	PN 6/10
Port-to-port length:	311 mm
Flange size for motor:	56C
Connect code:	F
Liquid:	
Pumped liquid:	Water
Liquid temperature range:	-25 .. 120 °C
Selected liquid temperature:	20 °C
Density at selected liquid temperature:	998.2 kg/m ³
Electrical data:	
Motor type:	71A
IE Efficiency class:	IE5
Rated power - P2:	2 x 0.25 kW
Mains frequency:	50 / 60 Hz
Rated voltage:	3 x 380-500 V
Rated current:	0.90-0.75 A
Cos phi - power factor:	0.58-0.50
Rated speed:	360-4000 rpm
Efficiency:	81.2%
Motor efficiency at full load:	81.2 %
Enclosure class (IEC 34-5):	IP55
Insulation class (IEC 85):	F
Motor protec:	YES
Motor No:	99138013
Controls:	
Control panel:	HMI200 - Standard
Function Module:	FM300 - Advanced
Frequency converter:	Built-in
Others:	

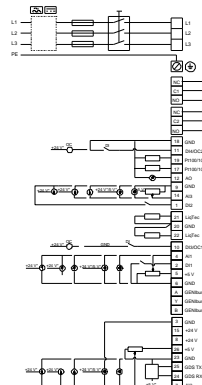
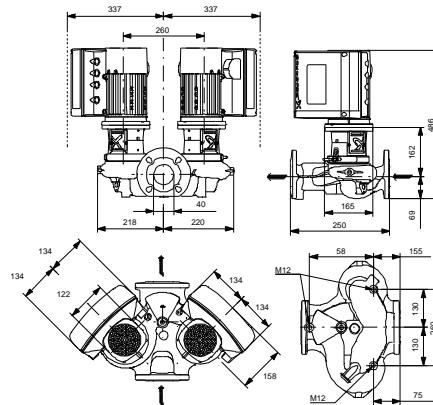
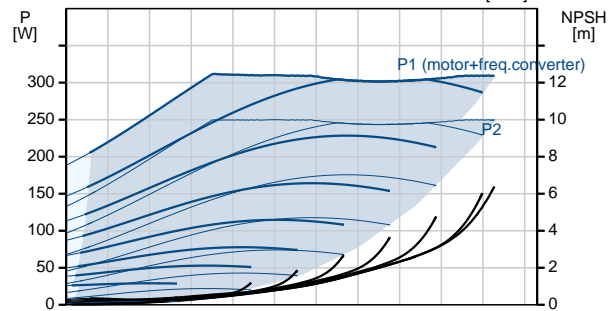
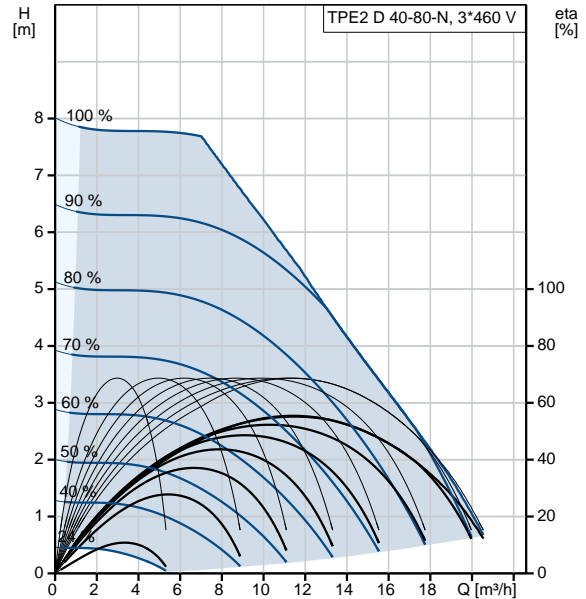



Company name:

Created by:

Phone:

Date:

20/12/2019

Description	Value
Minimum efficiency index, MEI :	0.7
ErP status:	EuP Standalone/Prod.
Net weight:	48.4 kg
Gross weight:	61.7 kg
Shipping volume:	0.246 m ³
Config. file no:	98819250
Country of origin:	HU
Custom tariff no.:	84137065

98438130 TPE2 D 40-80-N A-F-A-BQQE

