

Qty.	Description
1	<p data-bbox="199 338 533 367">TPE2 40-150-N A-F-A-BQQE</p>  <p data-bbox="199 660 469 689">Product No.: 98437887</p> <p data-bbox="199 719 1445 797">Single-stage, close-coupled, volute pump with in-line suction and discharge ports of identical diameter. The pump is of the top-pull-out design, i.e. the power head (motor, pump head and impeller) can be removed for maintenance or service while the pump housing remains in the pipework.</p> <p data-bbox="199 804 1414 860">The shaft seal is according to EN 12756. Pipework connection is via PN 6/10 DIN flanges (EN 1092-2 and ISO 7005-2).</p> <p data-bbox="199 866 1441 922">The pump is fitted with a fan-cooled, permanent-magnet synchronous motor. The motor efficiency is classified as IE5 in accordance with IEC 60034-30-2.</p> <p data-bbox="199 929 1430 983">The motor includes a frequency converter and PI controller in the motor terminal box. This enables continuously variable control of the motor speed, which again enables adaptation of the performance to a given requirement.</p> <p data-bbox="199 1039 316 1068">Controls:</p> <p data-bbox="199 1070 643 1099">Frequency converter: Built-in</p> <p data-bbox="199 1128 288 1158">Liquid:</p> <p data-bbox="199 1160 707 1279">Pumped liquid: Water Liquid temperature range: -25 .. 120 °C Liquid temperature during operation: 20 °C Density: 998.2 kg/m³</p> <p data-bbox="199 1308 328 1337">Technical:</p> <p data-bbox="199 1339 820 1514">Pump speed on which pump data are based: 3900 rpm Rated flow: 16.1 m³/h Rated head: 9.3 m Actual impeller diameter: 74 mm Primary shaft seal: BQQE Curve tolerance: ISO9906:2012 3B</p> <p data-bbox="199 1543 320 1572">Materials:</p> <p data-bbox="199 1574 879 1693">Pump housing: Cast iron EN-JL1040 ASTM A48-40 B Impeller: Composite PES/PP 30% GF</p> <p data-bbox="199 1722 344 1751">Installation:</p> <p data-bbox="199 1753 692 1962">Range of ambient temperature: -20 .. 50 °C Maximum operating pressure: 10 bar Flange standard: DIN Pipe connection: DN 40 Pressure rating: PN 6/10 Port-to-port length: 250 mm Flange size for motor: 56C</p> <p data-bbox="199 1991 381 2020">Electrical data:</p> <p data-bbox="199 2022 659 2116">Motor type: 71A IE Efficiency class: IE5 Rated power - P2: 0.55 kW</p>

Qty.	Description
------	-------------

Mains frequency:	50 Hz
Rated voltage:	3 x 380-500 V
Rated current:	1.35-1.30 A
Cos phi - power factor:	0.77-0.61
Rated speed:	360-4000 rpm
Efficiency:	85.9%
Motor efficiency at full load:	85.9 %
Enclosure class (IEC 34-5):	IP55
Insulation class (IEC 85):	F

Others:

Minimum efficiency index, MEI =:	0.7
ErP status:	EuP Standalone/Prod.
Net weight:	24.4 kg
Gross weight:	31.9 kg
Shipping volume:	0.1 m ³
Country of origin:	HU
Custom tariff no.:	84137051

98437887 TPE2 40-150-N A-F-A-BQQE 50 Hz

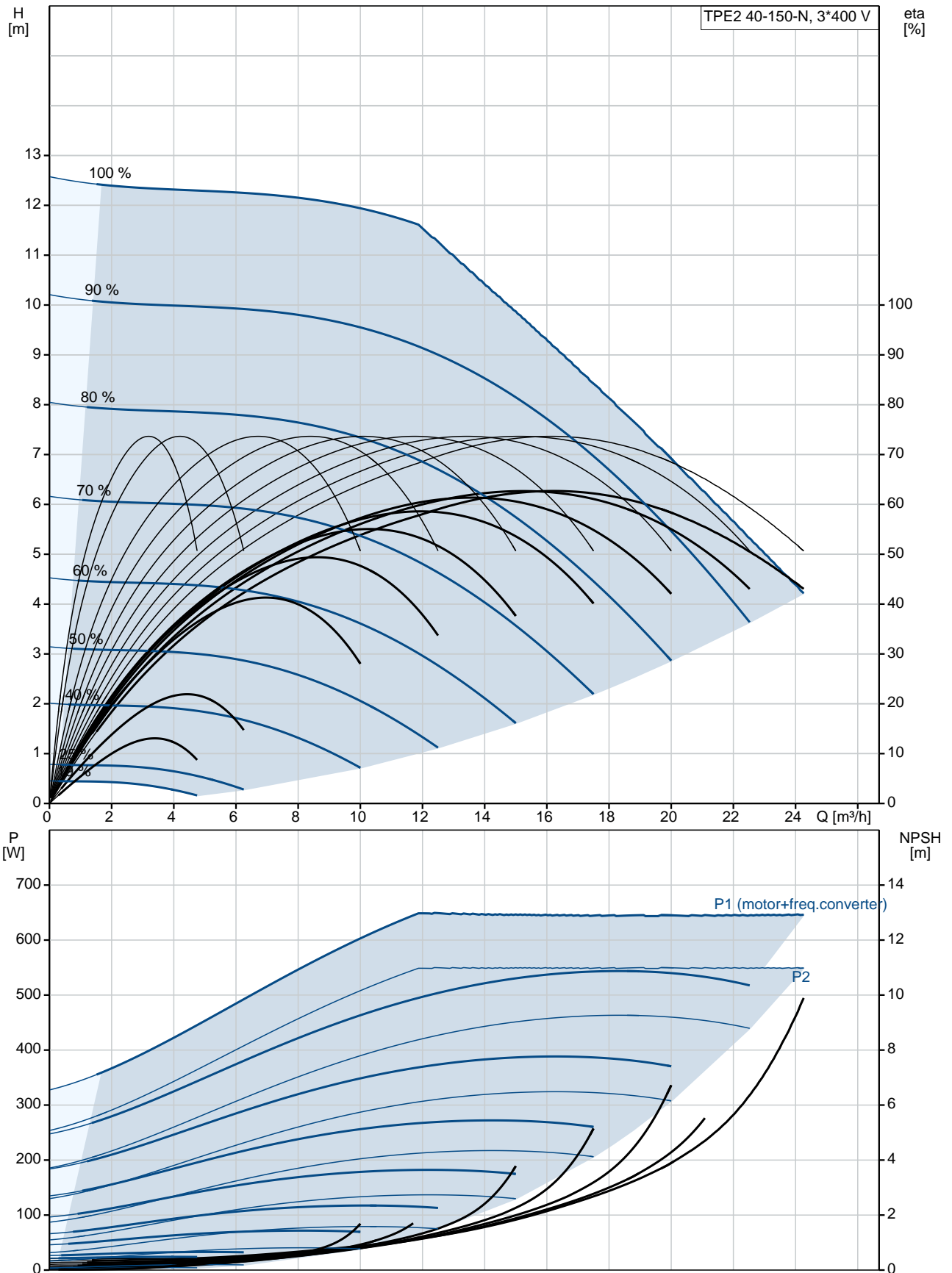

Description	Value
General information:	
Product name:	TPE2 40-150-N A-F-A-BQQE
Product No:	98437887
EAN number:	5711495010836
Price:	2.462,00 GBP
Technical:	
Pump speed on which pump data are based:	3900 rpm
Rated flow:	16.1 m ³ /h
Rated head:	9.3 m
Head max:	150 dm
Actual impeller diameter:	74 mm
Primary shaft seal:	BQQE
Curve tolerance:	ISO9906:2012 3B
Pump version:	A
Model:	A
Materials:	
Pump housing:	Cast iron
	EN-JL1040
	ASTM A48-40 B
Impeller:	Composite PES/PP 30% GF
Material code:	A
Installation:	
Range of ambient temperature:	-20 .. 50 °C
Maximum operating pressure:	10 bar
Flange standard:	DIN
Pipe connection:	DN 40
Pressure rating:	PN 6/10
Port-to-port length:	250 mm
Flange size for motor:	56C
Connect code:	F
Liquid:	
Pumped liquid:	Water
Liquid temperature range:	-25 .. 120 °C
Liquid temperature during operation:	20 °C
Density:	998.2 kg/m ³
Electrical data:	
Motor type:	71A
IE Efficiency class:	IE5
Rated power - P2:	0.55 kW
Mains frequency:	50 Hz
Rated voltage:	3 x 380-500 V
Rated current:	1.35-1.30 A
Cos phi - power factor:	0.77-0.61
Rated speed:	360-4000 rpm
Efficiency:	85.9%
Motor efficiency at full load:	85.9%
Enclosure class (IEC 34-5):	IP55
Insulation class (IEC 85):	F
Motor protec:	YES
Motor No:	99138016
Controls:	
Control panel:	HMI200 - Standard
Function Module:	FM300 - Advanced
Frequency converter:	Built-in
Others:	
Minimum efficiency index, MEI =:	0.7
ErP status:	EuP Standalone/Prod.

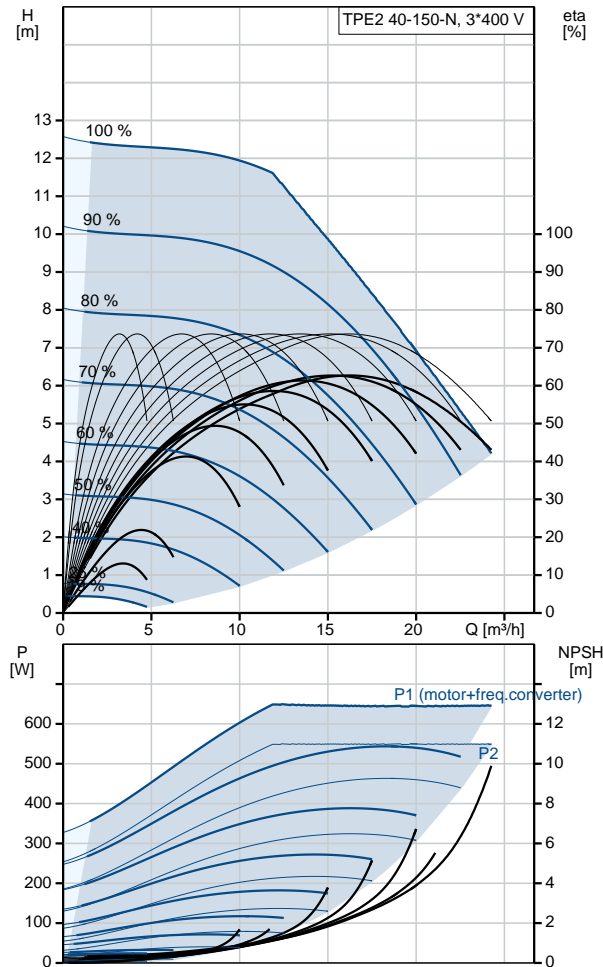



Company name:

Created by:

Phone:

Date:

21/12/2018

Description	Value
Net weight:	24.4 kg
Gross weight:	31.9 kg
Shipping volume:	0.1 m ³
Config. file no:	98819253
Country of origin:	HU
Custom tariff no.:	84137051

98437887 TPE2 40-150-N A-F-A-BQQE 50 Hz

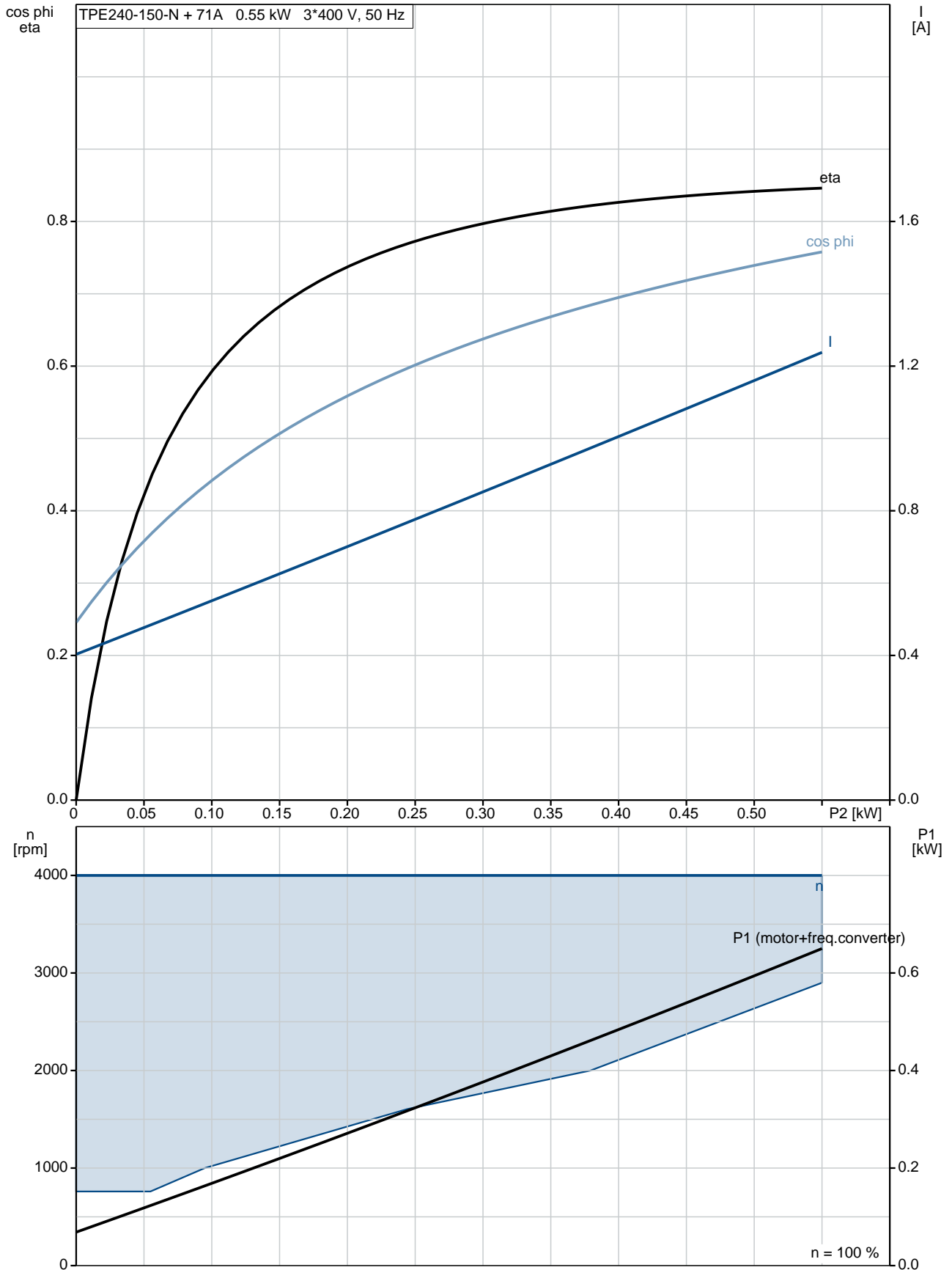

98437887 TPE2 40-150-N A-F-A-BQQE 50 Hz

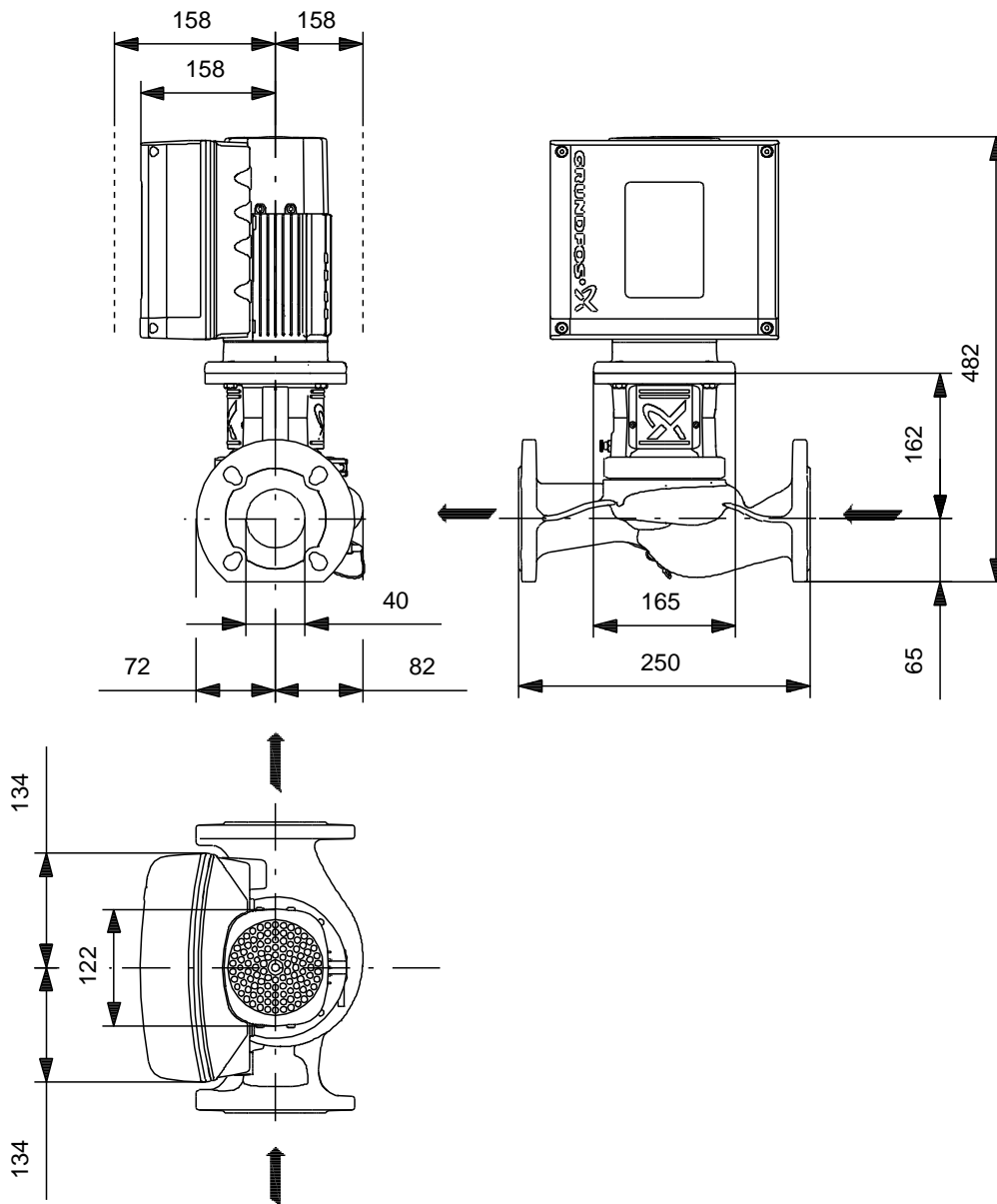

Note! All units are in [mm] unless others are stated.
Disclaimer: This simplified dimensional drawing does not show all details.

98437887 TPE2 40-150-N A-F-A-BQQE 50 Hz

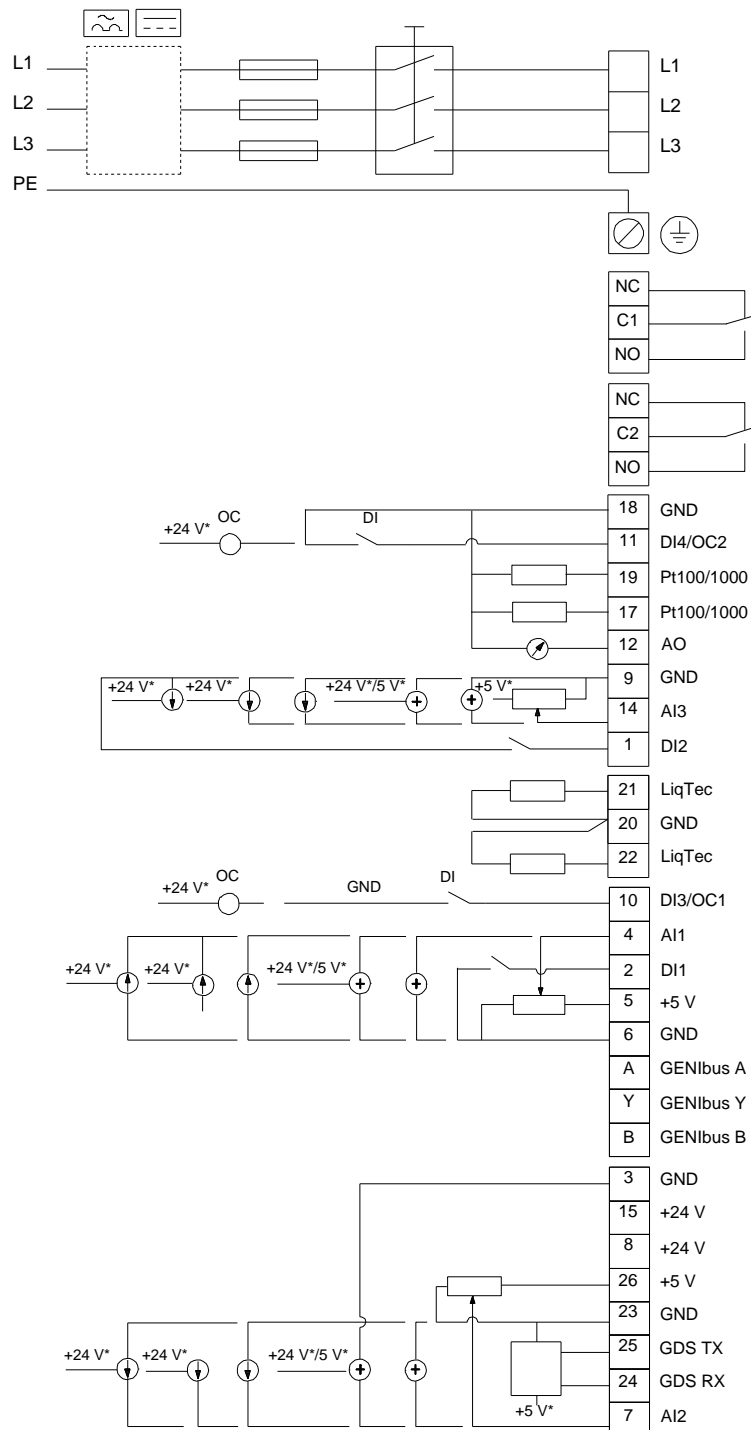

Note! All units are in [mm] unless others are stated.