

Position	Count	Description
	1	<p><b>CME3-3 A-R-G-E-AQQE</b></p>  <p>Product No.: <a href="#">98395153</a></p> <p>Compact, reliable, horizontal, multistage, end-suction centrifugal pump with axial suction port and radial discharge port. Pump materials in contact with the liquid are in high-grade stainless steel. The mechanical shaft seal is a special designed, unbalanced O-ring seal. Pipework connection is via internal Whitworth pipe threads, Rp (ISO 7/1).</p> <p>The pump is fitted with a 3-phase, fan-cooled, permanent-magnet, synchronous motor. The motor includes a frequency converter and PI controller in the motor terminal box. This enables continuously variable control of the motor speed, which again enables adaptation of the performance to a given requirement.</p> <p><b>Liquid:</b>  Pumped liquid: Water  Liquid temperature range: -4 .. 248 °F  Liquid temperature during operation: 68 °F  Density: 62.29 lb/ft<sup>3</sup></p> <p><b>Technical:</b>  Rated flow: 16.3 US gpm  Rated head: 96.13 ft  Primary shaft seal: AQQE  Approvals on nameplate: CE,TR,CURUS,EAC  Curve tolerance: ISO9906:2012 3B</p> <p><b>Materials:</b>  Pump housing: Stainless steel  DIN W.-Nr. 1.4401  AISI 316  Impeller: Stainless steel  DIN W.-Nr. 1.4401  AISI 316  Rubber: EPDM</p> <p><b>Installation:</b>  Maximum ambient temperature: 104 °F  Maximum operating pressure: 232 psi  Max pressure at stated temperature: 145 psi / 250 °F  232 psi / 194 °F  Flange standard: WHITWORTH THREAD RP  Pump inlet: Rp 1  Pump outlet: Rp 1</p> <p><b>Electrical data:</b>  Motor type: 80B  IE Efficiency class: IE5  Rated power - P2: 1.5 HP  Main frequency: 60 Hz  Rated voltage: 3 x 380-500 V  Rated current: 2.20-1.90 A</p>

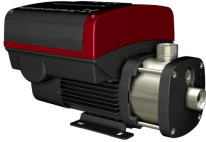

Company name:

Created by:

Phone:

Date:

10/9/2018

Position	Count	Description
		Rated speed: 360-4000 rpm Enclosure class (IEC 34-5): IP55 Insulation class (IEC 85): F  <b>Others:</b> Minimum efficiency index, MEI : 0.7 Net weight: 33.3 lb Gross weight: 41 lb Country of origin: HU Custom tariff no.: 84137075

## 98395153 CME3-3 A-R-G-E-AQQE 60 Hz

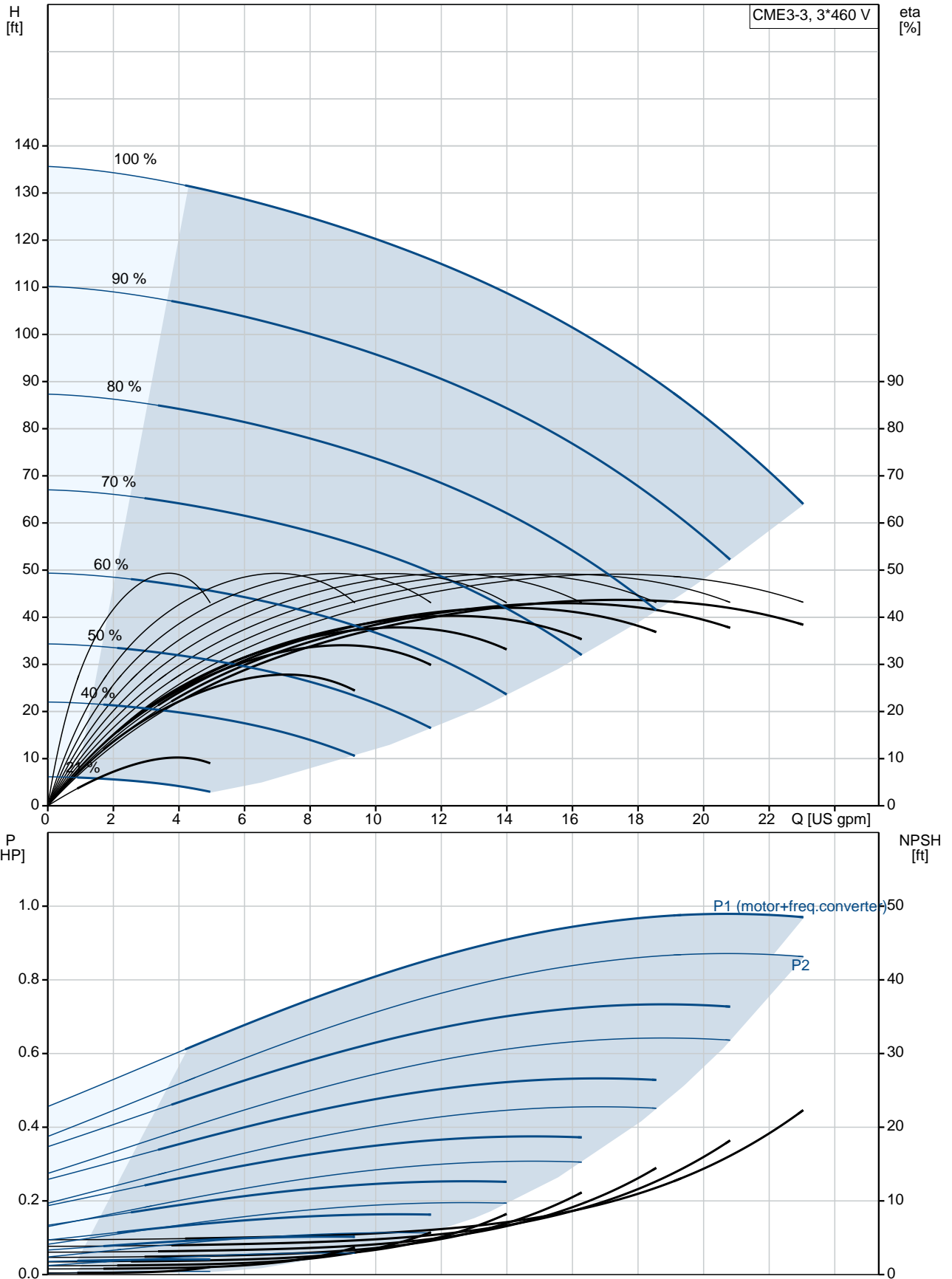

Description	Value
<b>General information:</b>	
Product name:	CME3-3 A-R-G-E-AQQE
Product No.:	98395153
EAN:	5711494285068
<b>Technical:</b>	
Rated flow:	16.3 US gpm
Rated head:	96.13 ft
Impellers:	3
Primary shaft seal:	AQQE
Approvals on nameplate:	CE,TR,CURUS,EAC
Curve tolerance:	ISO9906:2012 3B
Pump version:	A
Model:	A
<b>Materials:</b>	
Pump housing:	Stainless steel DIN W.-Nr. 1.4401 AISI 316
Impeller:	Stainless steel DIN W.-Nr. 1.4401 AISI 316
Material code:	G
Rubber:	EPDM
Code for rubber:	E
<b>Installation:</b>	
Maximum ambient temperature:	104 °F
Maximum operating pressure:	232 psi
Max pressure at stated temperature:	145 psi / 250 °F 232 psi / 194 °F
Flange standard:	WHITWORTH THREAD RP
Pump inlet:	Rp 1
Pump outlet:	Rp 1
Connect code:	R
<b>Liquid:</b>	
Pumped liquid:	Water
Liquid temperature range:	-4 .. 248 °F
Liquid temperature during operation:	68 °F
Density:	62.29 lb/ft³
<b>Electrical data:</b>	
Motor type:	80B
IE Efficiency class:	IE5
Rated power - P2:	1.5 HP
Main frequency:	60 Hz
Rated voltage:	3 x 380-500 V
Rated current:	2.20-1.90 A
Rated speed:	360-4000 rpm
Enclosure class (IEC 34-5):	IP55
Insulation class (IEC 85):	F
<b>Others:</b>	
Minimum efficiency index, MEI :	0.7
Net weight:	33.3 lb
Gross weight:	41 lb
Config. file no:	98498727
Country of origin:	HU
Custom tariff no.:	84137075

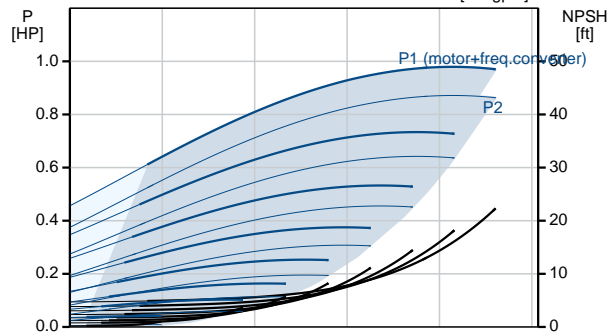
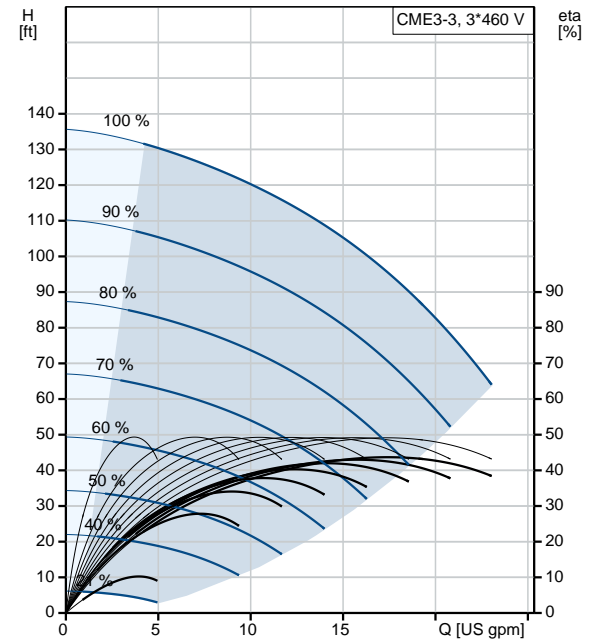

## 98395153 CME3-3 A-R-G-E-AQQE 60 Hz

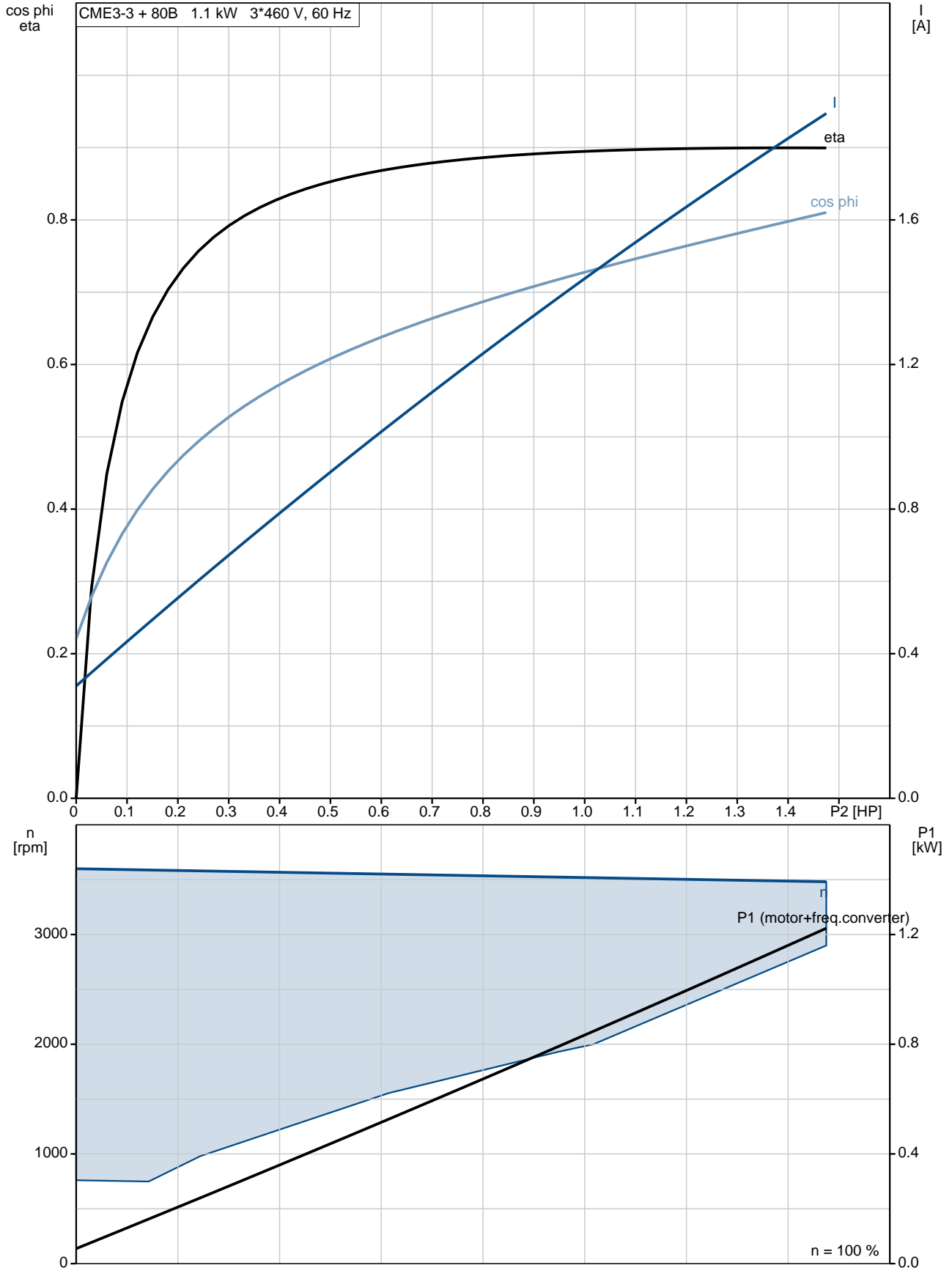

## 98395153 CME3-3 A-R-G-E-AQQE 60 Hz

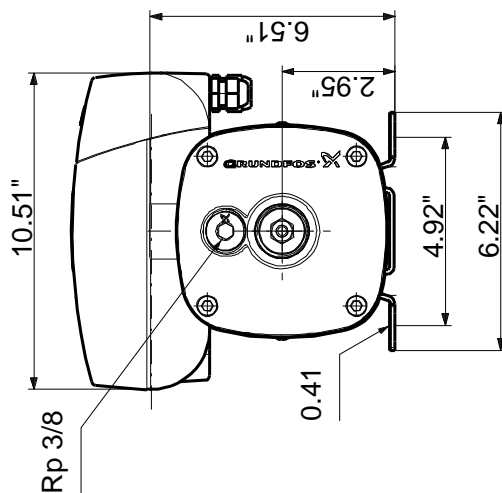
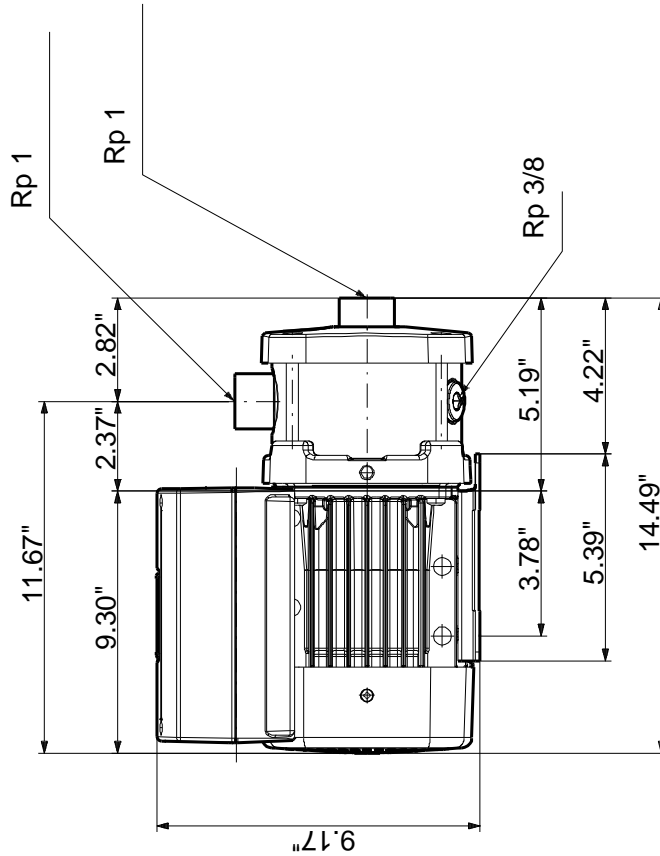

Note! All units are in [mm] unless otherwise stated.  
Disclaimer: This simplified dimensional drawing does not show all details.

## 98395153 CME3-3 A-R-G-E-AQQE 60 Hz

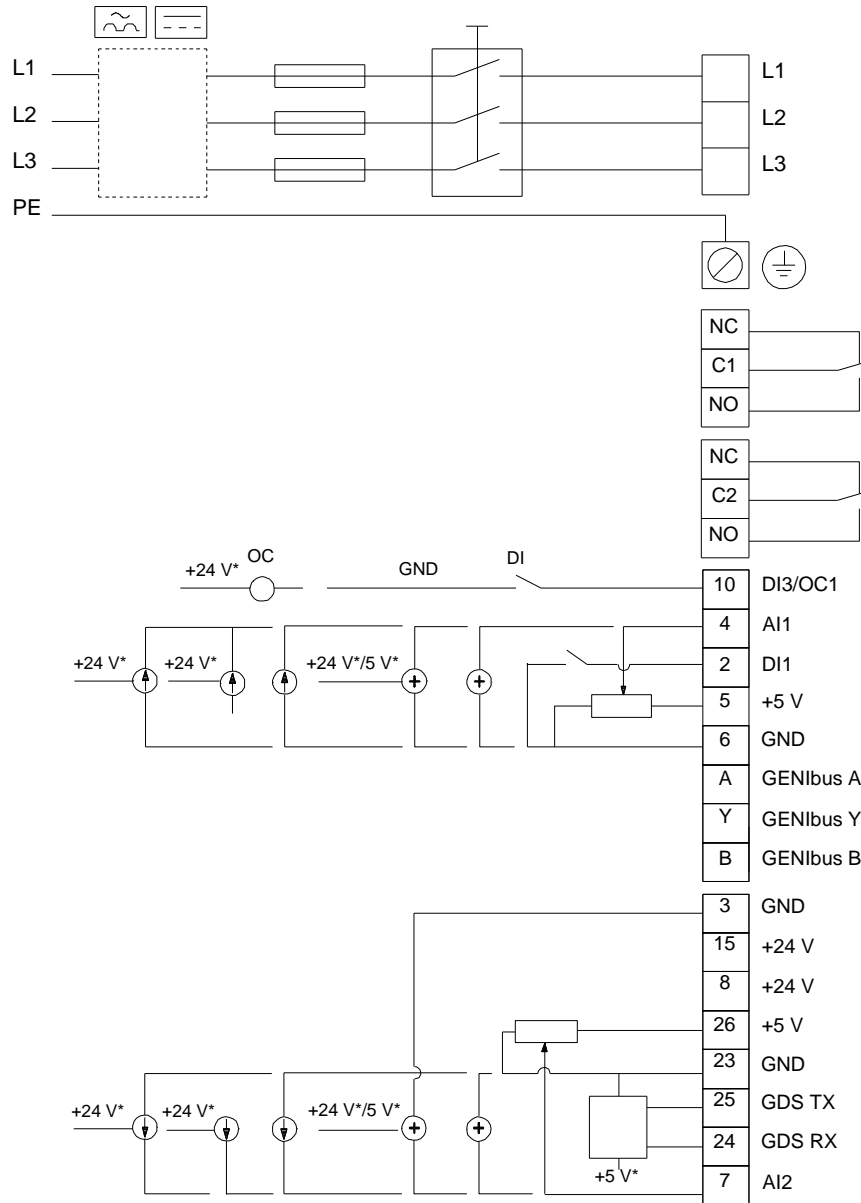

All units are [mm] unless otherwise presented.