

Position	Qty.	Description
	1	<p>CME1-3 A-R-I-E-AQQE</p>  <p>Product No.: 98394859</p> <p>Compact, reliable, horizontal, multistage, end-suction centrifugal pump with axial suction port and radial discharge port. Pump materials in contact with the liquid are in stainless steel. The mechanical shaft seal is a special designed, unbalanced O-ring seal. Pipework connection is via internal Whitworth pipe threads, Rp (ISO 7/1).</p> <p>The pump is fitted with a 3-phase, fan-cooled, permanent-magnet, synchronous motor. The motor efficiency is classified as IE5 in accordance with IEC 60034-30-2.</p> <p>The motor includes a frequency converter and PI controller in the motor terminal box. This enables continuously variable control of the motor speed, which again enables adaptation of the performance to a given requirement.</p> <p>An operating panel on the motor terminal box enables setting of required setpoint as well as setting of pump to "Min." or "Max." operation or to "Stop". The Grundfos Eye indicator on the operating panel provides visual indication of pump status:</p> <ul style="list-style-type: none"> • "Power on": Motor is running (rotating green indicator lights) or not running (permanently green indicator lights) • "Warning": Motor is still running (rotating yellow indicator lights) or has stopped (permanently yellow indicator lights) • "Alarm": Motor has stopped (flashing red indicator lights). <p>Communication with the pump is possible by means of Grundfos GO Remote (accessory). The remote control enables further settings as well as reading out of a number of parameters such as "Actual value", "Speed", "Power input" and total "Power consumption".</p> <p>The terminal box holds terminals for these connections:</p> <ul style="list-style-type: none"> • one dedicated digital input • two analog inputs, 0(4)-20 mA, 0-5 V, 0-10 V, 0.5 - 3.5 V • 5 V voltage supply to potentiometer and sensor • one configurable digital input or open-collector output • Grundfos Digital Sensor input and output • 24 V voltage supply for sensors • two signal-relay outputs (potential-free contacts) • GENIbus connection • interface for Grundfos CIM fieldbus module. <p>Liquid: Pumped liquid: Water Liquid temperature range: -20 .. 120 °C Liquid temperature during operation: 20 °C Density: 998.2 kg/m³</p> <p>Technical: Rated flow: 2 m³/h Rated head: 26.2 m Primary shaft seal: AQQE</p>

Position	Qty.	Description
		<p>Approvals on nameplate: CE,TR,CURUS,EAC Curve tolerance: ISO9906:2012 3B</p> <p>Materials: Pump housing: Stainless steel DIN W.-Nr. 1.4301 AISI 304 Impeller: Stainless steel DIN W.-Nr. 1.4301 AISI 304 Rubber: EPDM</p> <p>Installation: Maximum ambient temperature: 40 °C Maximum operating pressure: 16 bar Max pressure at stated temp: 10 bar / 120 °C 16 bar / 90 °C Flange standard: WHITWORTH THREAD RP Pump inlet: Rp 1 Pump outlet: Rp 1</p> <p>Electrical data: Motor type: 71A IE Efficiency class: IE5 Rated power - P2: 0.55 kW Mains frequency: 50 Hz Rated voltage: 3 x 380-500 V Rated current: 1.35-1.30 A Rated speed: 360-4000 rpm Enclosure class (IEC 34-5): IP55 Insulation class (IEC 85): F</p> <p>Others: Minimum efficiency index, MEI : 0.68 Net weight: 14.4 kg Gross weight: 17.9 kg</p>

98394859 CME1-3 A-R-I-E-AQQE 50 Hz

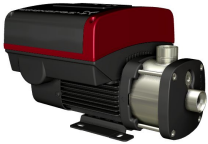
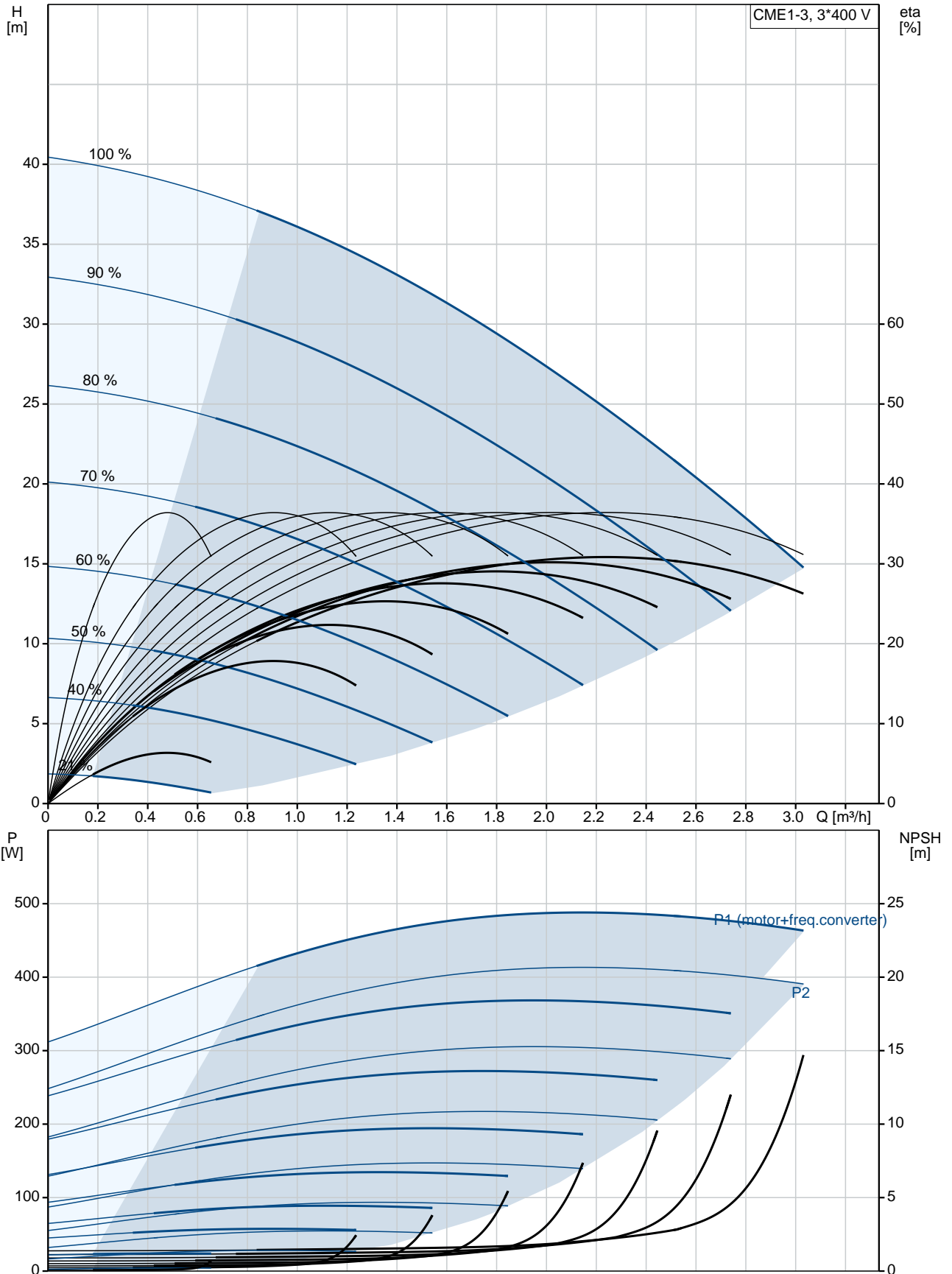

Description	Value
General information:	
Product name:	CME1-3 A-R-I-E-AQQE
Product No:	98394859
EAN number:	5711494279418
Technical:	
Rated flow:	2 m³/h
Rated head:	26.2 m
Impellers:	3
Primary shaft seal:	AQQE
Approvals on nameplate:	CE,TR,CURUS,EAC
Curve tolerance:	ISO9906:2012 3B
Pump version:	A
Model:	A
Materials:	
Pump housing:	Stainless steel DIN W.-Nr. 1.4301 AISI 304
Impeller:	Stainless steel DIN W.-Nr. 1.4301 AISI 304
Material code:	I
Rubber:	EPDM
Code for rubber:	E
Installation:	
Maximum ambient temperature:	40 °C
Maximum operating pressure:	16 bar
Max pressure at stated temp:	10 bar / 120 °C 16 bar / 90 °C
Flange standard:	WHITWORTH THREAD RP
Pump inlet:	Rp 1
Pump outlet:	Rp 1
Connect code:	R
Liquid:	
Pumped liquid:	Water
Liquid temperature range:	-20 .. 120 °C
Liquid temperature during operation:	20 °C
Density:	998.2 kg/m³
Electrical data:	
Motor type:	71A
IE Efficiency class:	IE5
Rated power - P2:	0.55 kW
Mains frequency:	50 Hz
Rated voltage:	3 x 380-500 V
Rated current:	1.35-1.30 A
Rated speed:	360-4000 rpm
Enclosure class (IEC 34-5):	IP55
Insulation class (IEC 85):	F
Others:	
Minimum efficiency index, MEI :	0.68
Net weight:	14.4 kg
Gross weight:	17.9 kg
Config. file no:	98498396

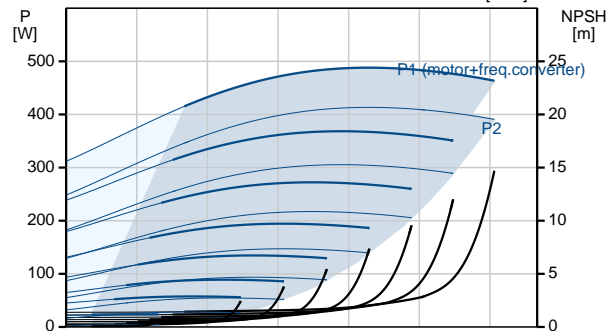
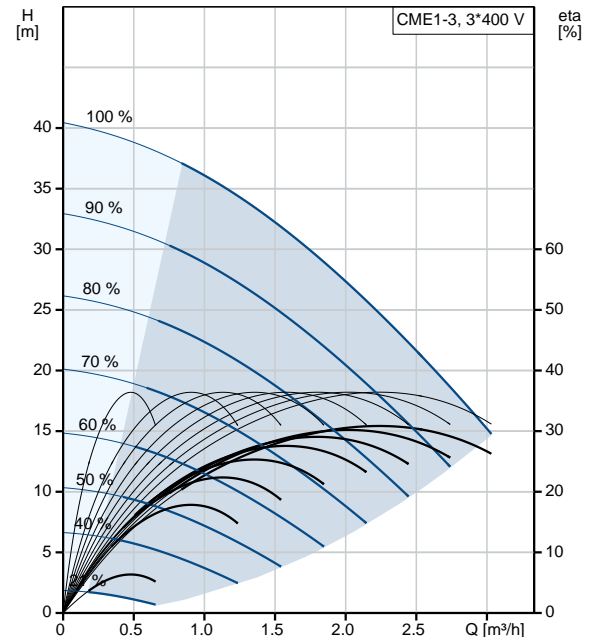

98394859 CME1-3 A-R-I-E-AQQE 50 Hz

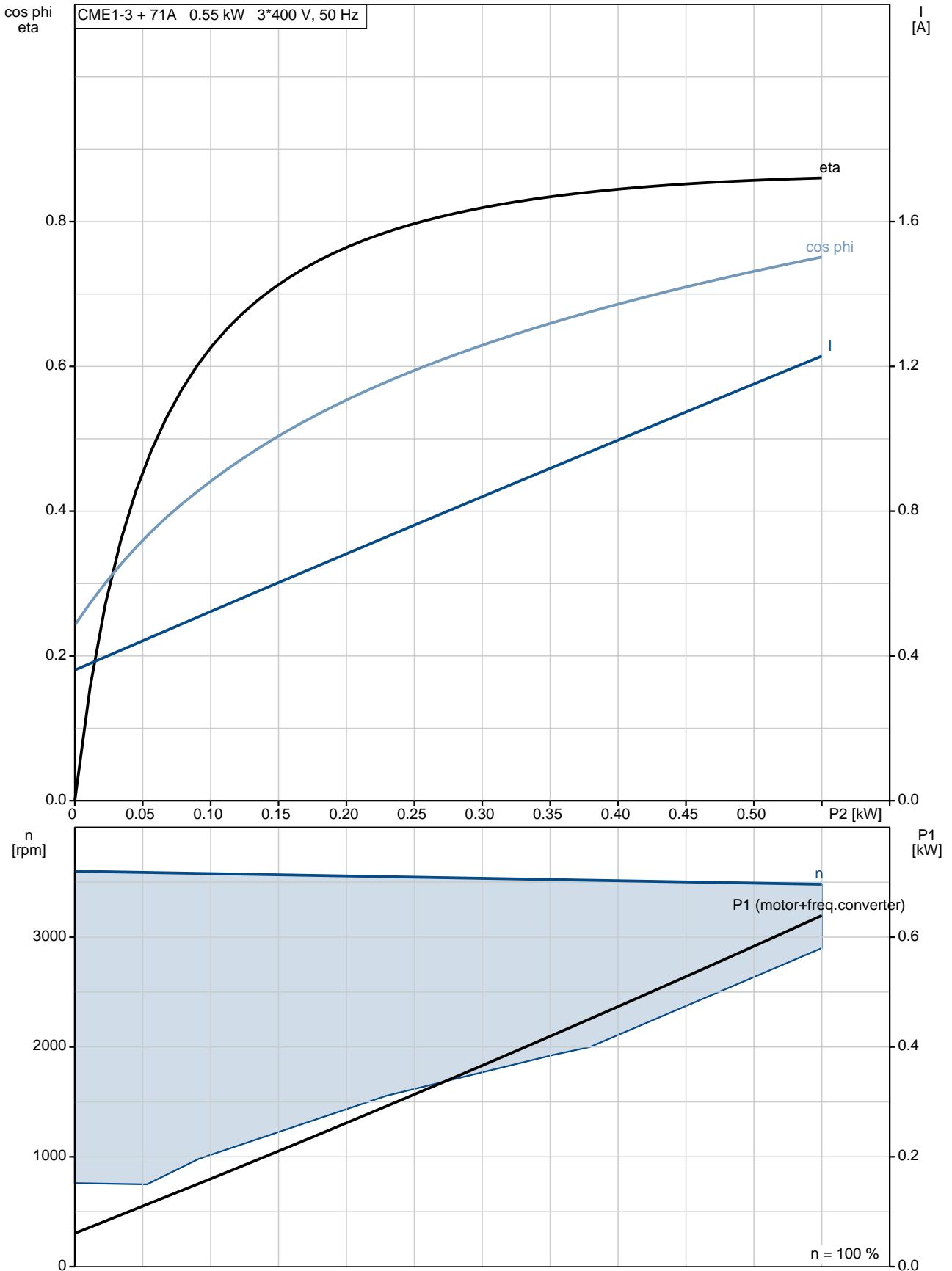

98394859 CME1-3 A-R-I-E-AQQE 50 Hz

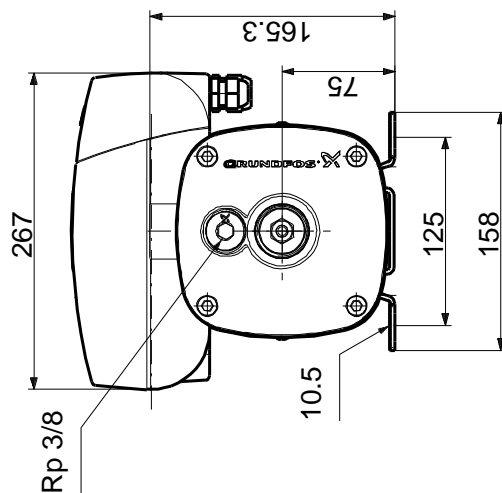
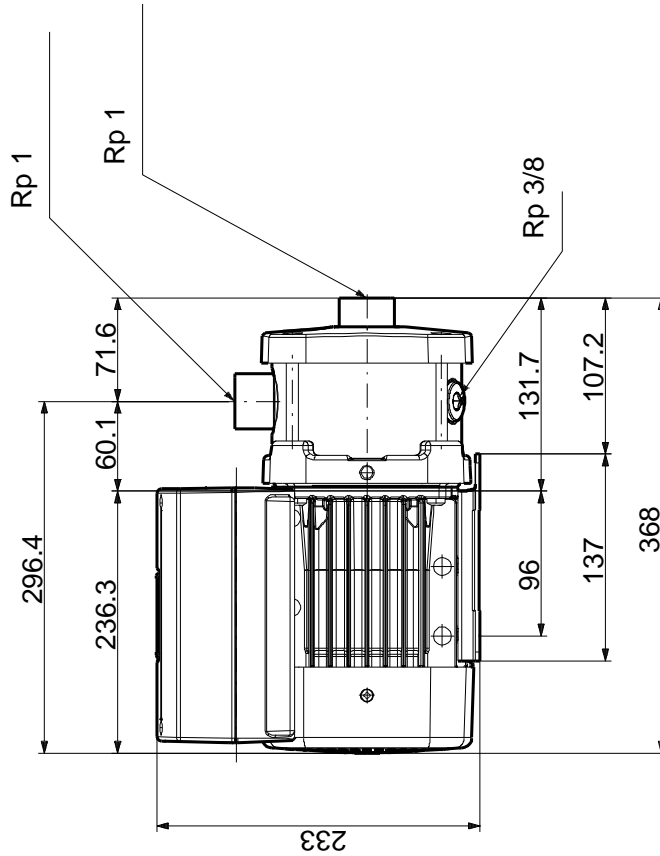

Note! All units are in [mm] unless others are stated.
 Disclaimer: This simplified dimensional drawing does not show all details.

98394859 CME1-3 A-R-I-E-AQQE 50 Hz

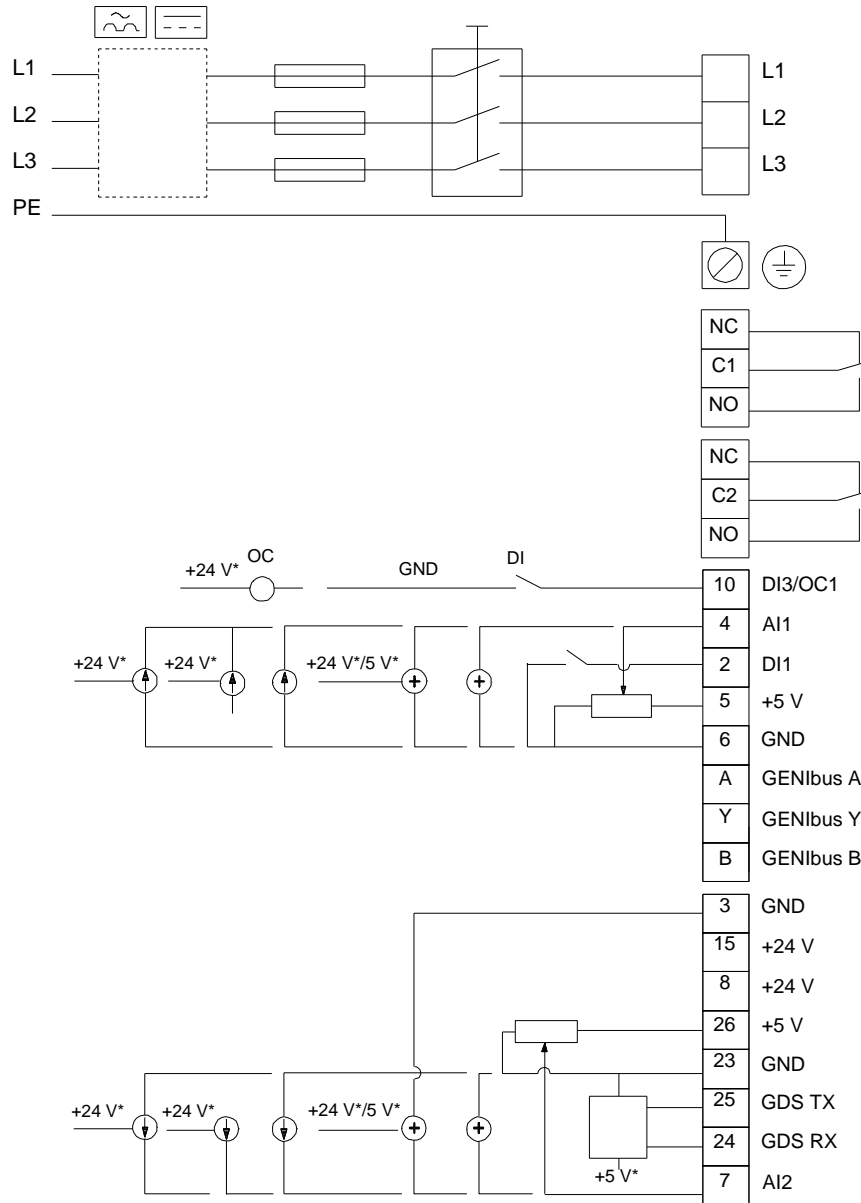

Note! All units are in [mm] unless others are stated.