

Position	Count	Description
	1	<p>CME1-4 A-R-G-E-AQQE</p>  <p>Product No.: 98394768</p> <p>Compact, reliable, horizontal, multistage, end-suction centrifugal pump with axial suction port and radial discharge port. Pump materials in contact with the liquid are in high-grade stainless steel. The mechanical shaft seal is a special designed, unbalanced O-ring seal. Pipework connection is via internal Whitworth pipe threads, Rp (ISO 7/1).</p> <p>The pump is fitted with a 1-phase, fan-cooled, permanent-magnet, synchronous motor. The motor includes a frequency converter and PI controller in the motor terminal box. This enables continuously variable control of the motor speed, which again enables adaptation of the performance to a given requirement.</p> <p>Liquid: Pumped liquid: Water Liquid temperature range: -4 .. 248 °F Liquid temperature during operation: 68 °F Density: 62.29 lb/ft³</p> <p>Technical: Rated flow: 8.81 US gpm Rated head: 114.5 ft Primary shaft seal: AQQE Approvals on nameplate: CE,TR,CURUS,EAC Curve tolerance: ISO9906:2012 3B</p> <p>Materials: Pump housing: Stainless steel DIN W.-Nr. 1.4401 AISI 316 Impeller: Stainless steel DIN W.-Nr. 1.4401 AISI 316 Rubber: EPDM</p> <p>Installation: Maximum ambient temperature: 104 °F Maximum operating pressure: 232 psi Max pressure at stated temperature: 145 psi / 250 °F 232 psi / 194 °F Flange standard: WHITWORTH THREAD RP Pump inlet: Rp 1 Pump outlet: Rp 1</p> <p>Electrical data: Motor type: 71A IE Efficiency class: IE5 Rated power - P2: 0.75 HP Main frequency: 60 Hz Rated voltage: 1 x 200-240 V Rated current: 3.45-2.90 A</p>



Company name:

Created by:

Phone:

Date:

10/9/2018

Position	Count	Description
		Rated speed: 360-4000 rpm Enclosure class (IEC 34-5): IP55 Insulation class (IEC 85): F Others: Minimum efficiency index, MEI : 0.68 Net weight: 30.7 lb Gross weight: 38.4 lb Country of origin: HU Custom tariff no.: 84137075

98394768 CME1-4 A-R-G-E-AQQE 60 Hz

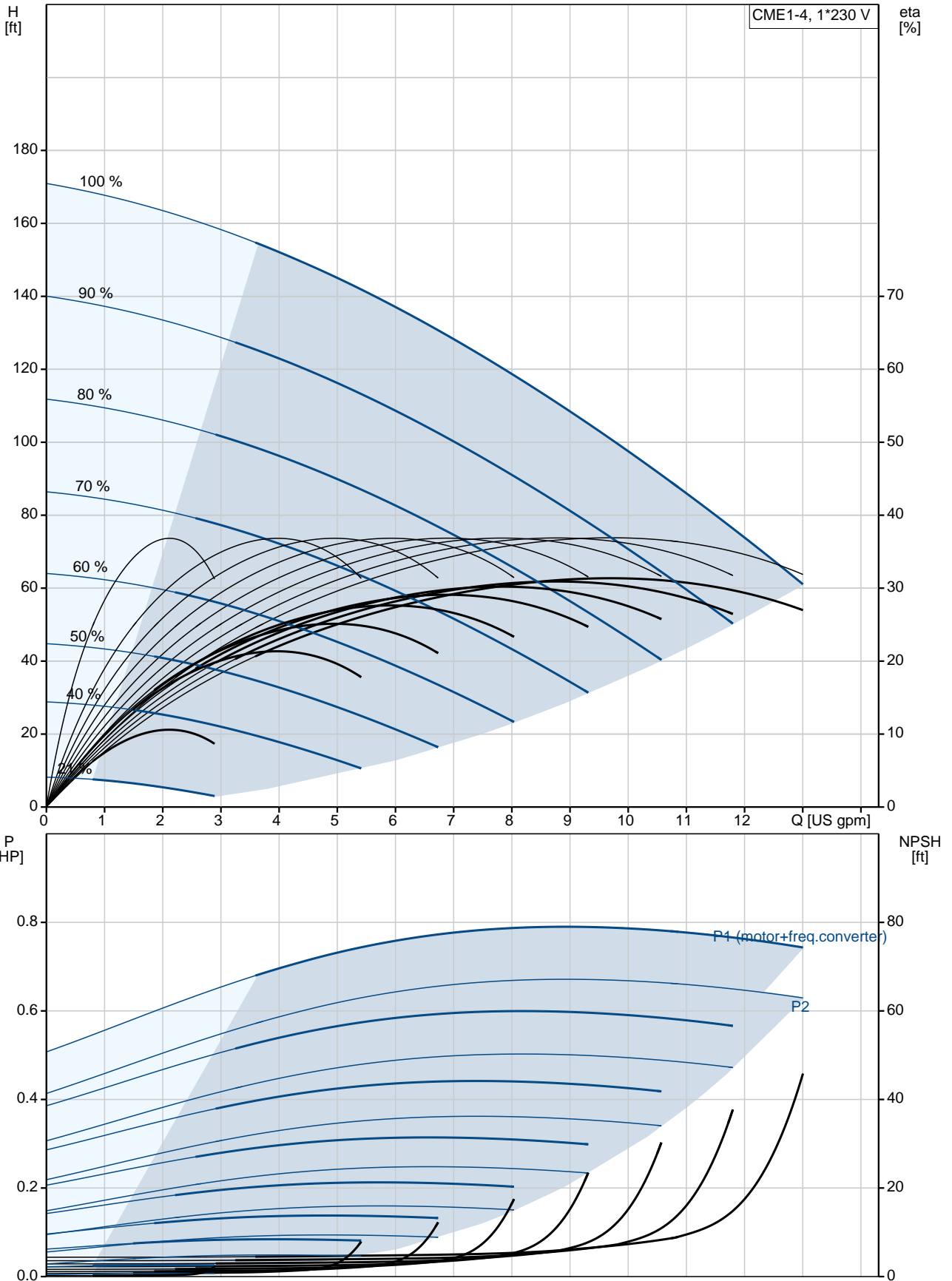

Description	Value
General information:	
Product name:	CME1-4 A-R-G-E-AQQE
Product No.:	98394768
EAN:	5711494277841
Technical:	
Rated flow:	8.81 US gpm
Rated head:	114.5 ft
Impellers:	4
Primary shaft seal:	AQQE
Approvals on nameplate:	CE,TR,CURUS,EAC
Curve tolerance:	ISO9906:2012 3B
Pump version:	A
Model:	A
Materials:	
Pump housing:	Stainless steel DIN W.-Nr. 1.4401 AISI 316
Impeller:	Stainless steel DIN W.-Nr. 1.4401 AISI 316
Material code:	G
Rubber:	EPDM
Code for rubber:	E
Installation:	
Maximum ambient temperature:	104 °F
Maximum operating pressure:	232 psi
Max pressure at stated temperature:	145 psi / 250 °F 232 psi / 194 °F
Flange standard:	WHITWORTH THREAD RP
Pump inlet:	Rp 1
Pump outlet:	Rp 1
Connect code:	R
Liquid:	
Pumped liquid:	Water
Liquid temperature range:	-4 .. 248 °F
Liquid temperature during operation:	68 °F
Density:	62.29 lb/ft³
Electrical data:	
Motor type:	71A
IE Efficiency class:	IE5
Rated power - P2:	0.75 HP
Main frequency:	60 Hz
Rated voltage:	1 x 200-240 V
Rated current:	3.45-2.90 A
Rated speed:	360-4000 rpm
Enclosure class (IEC 34-5):	IP55
Insulation class (IEC 85):	F
Others:	
Minimum efficiency index, MEI :	0.68
Net weight:	30.7 lb
Gross weight:	38.4 lb
Config. file no:	98498325
Country of origin:	HU
Custom tariff no.:	84137075

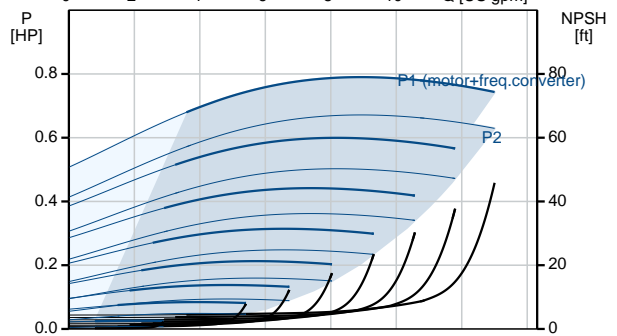
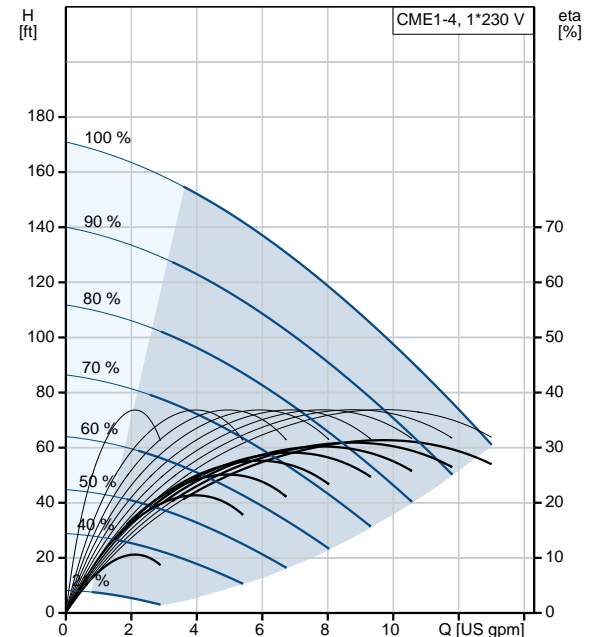

98394768 CME1-4 A-R-G-E-AQQE 60 Hz

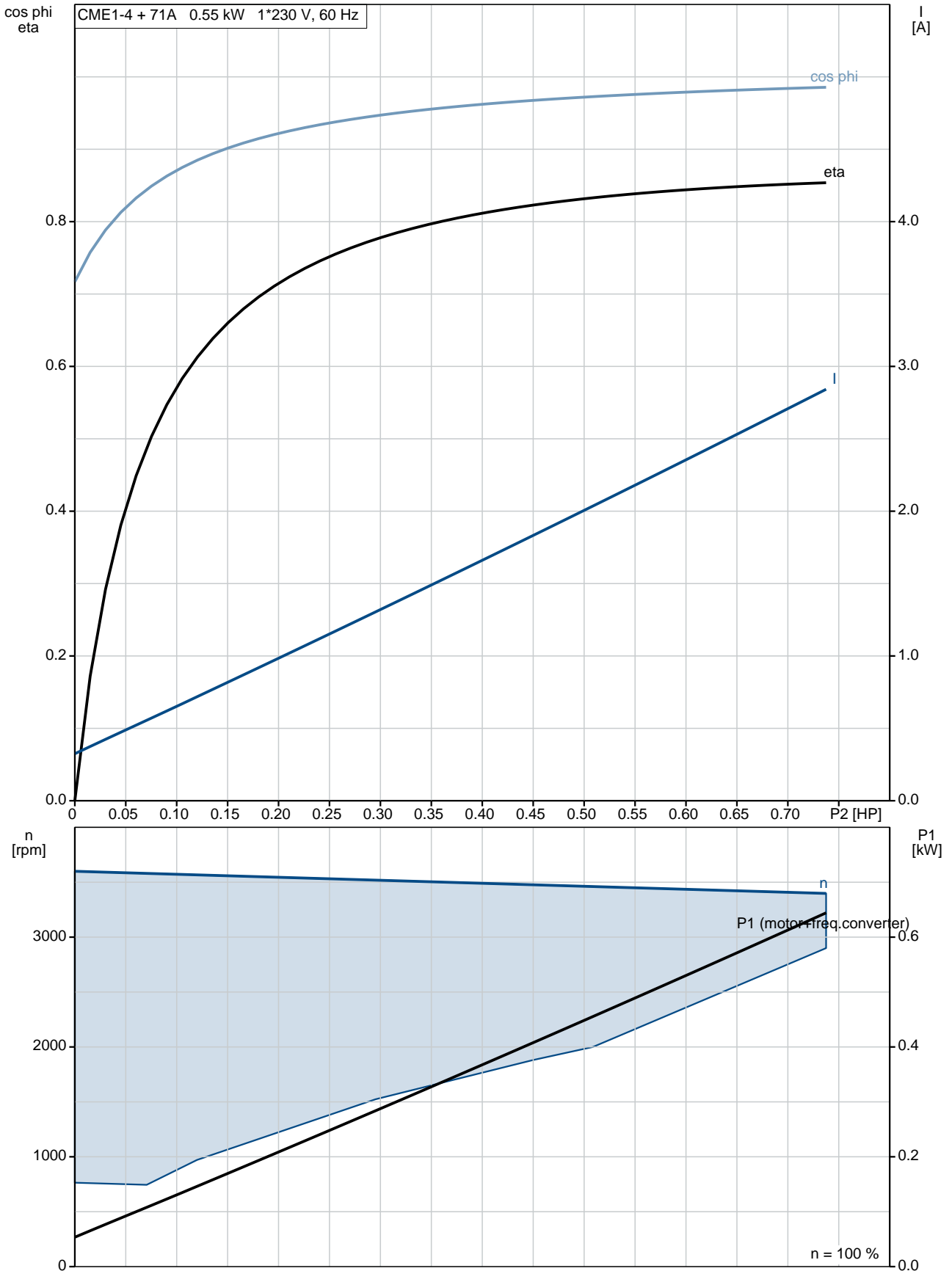

98394768 CME1-4 A-R-G-E-AQQE 60 Hz

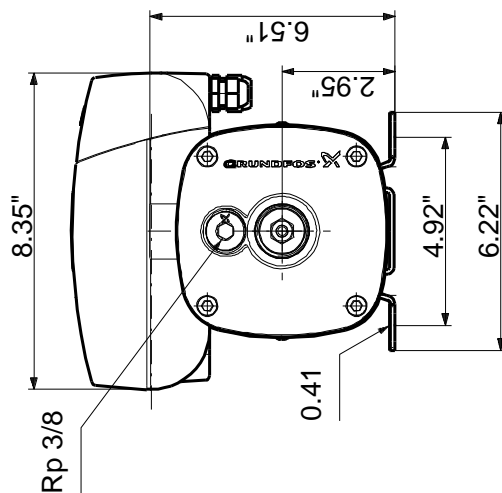
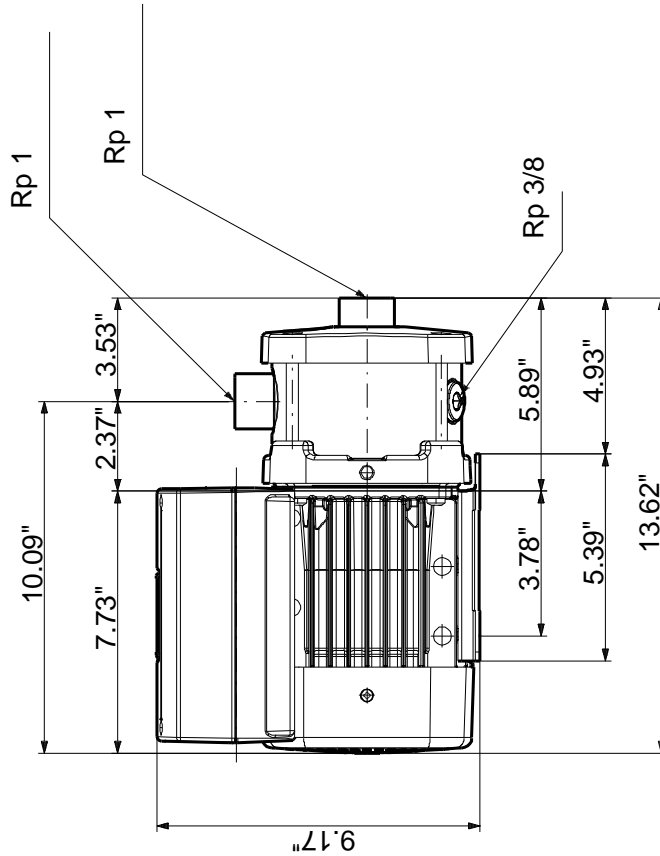

Note! All units are in [mm] unless otherwise stated.
Disclaimer: This simplified dimensional drawing does not show all details.

98394768 CME1-4 A-R-G-E-AQQE 60 Hz

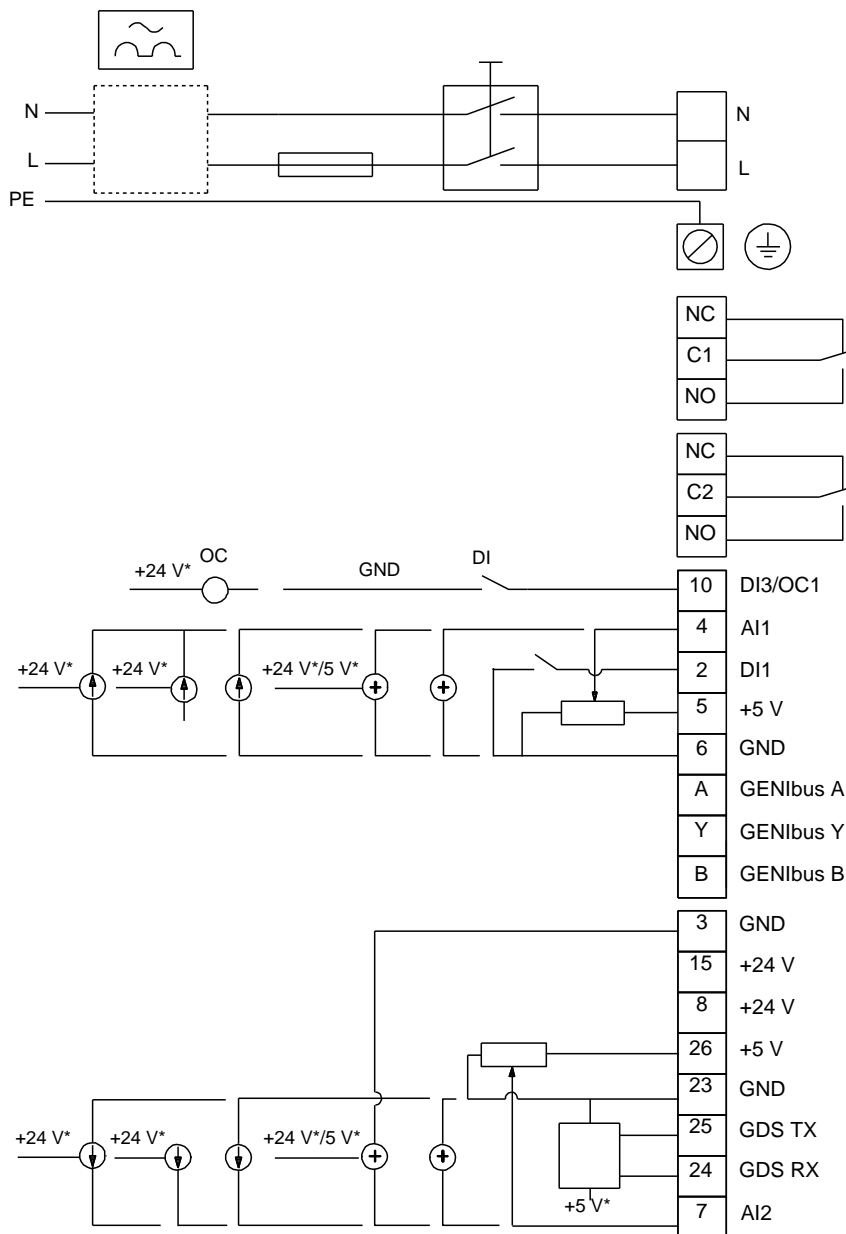

All units are [mm] unless otherwise presented.