

Position	Qty.	Description
	1	<p>MAGNA3 D 80-80 F</p>  <p>Product No.: 97924503</p> <p>MAGNA3 – More than a pump With its unrivalled efficiency, all-encompassing range and built-in communication capabilities plus functionalities replacing system components, the MAGNA3 is ideal for engineers and specifiers looking to create high-performance systems for buildings.</p> <p>This pump in the Grundfos Master Class will fit both heating and cooling applications perfectly, making it the obvious choice for almost any building project – old or new.</p> <p>The MAGNA3 is of the canned-rotor type, i.e. pump and motor form an integral unit without shaft seal and with only two gaskets for sealing. The bearings are lubricated by the pumped liquid. The innovative clamp with only one screw enables easy repositioning of the pump head. The MAGNA3 is a pump with no maintenance requirements and with extremely low Life Cycle Cost.</p> <p>The pump is characterised by the following:</p> <ul style="list-style-type: none"> • controller integrated in the control box • control panel with TFT display on the control box • control box prepared for optional CIM modules • built-in differential-pressure and temperature sensor • cast-iron pump housing (depending on model) • carbon-fibre-reinforced composite rotor can • stainless-steel bearing plate and rotor cladding • aluminium alloy stator housing • air-cooled power electronics <p>The MAGNA3 is a single-phase pump.</p> <p>Characteristic features</p> <ul style="list-style-type: none"> • AUTOADAPT. • FLOWADAPT and FLOWLIMIT (more than a pump function as it reduces the need for pump throttling valves). • Proportional-pressure control. • Constant-pressure control. • Constant-temperature control. • Constant-curve duty. • Max. or min. curve duty. • Automatic Night Setback. • No external motor protection required. • Insulating shells supplied with single-head pumps for heating systems. • Large temperature range where the liquid temperature and the ambient temperature are independent of each other. <p>Communication The MAGNA3 enables communication via the following:</p> <ul style="list-style-type: none"> • wireless Grundfos GO Remote • fieldbus communication via CIM modules • digital inputs • relay outputs • analog input (more than a pump function as heat energy meter)

Position	Qty.	Description
		<p>Motor and electronic controller The MAGNA3 incorporates a 4-pole synchronous, permanent-magnet motor (PM motor). This motor type is characterised by higher efficiency than a conventional asynchronous squirrel-cage motor. The pump speed is controlled by an integrated frequency converter. A differential-pressure and temperature sensor is incorporated in the pump.</p> <p>Liquid: Pumped liquid: Water Liquid temperature range: -10 .. 110 °C Liquid temp: 60 °C Density: 983.2 kg/m³</p> <p>Technical: TF class: 110 Approvals on nameplate: CE,VDE,EAC</p> <p>Materials: Pump housing: Cast iron EN-GJL-250 ASTM A48-250B Impeller: PES 30%GF</p> <p>Installation: Range of ambient temperature: 0 .. 40 °C Maximum operating pressure: 6 bar Flange standard: DIN Pipe connection: DN 80 Pressure stage: PN6 Port-to-port length: 360 mm</p> <p>Electrical data: Power input - P1: 26 .. 712 W Mains frequency: 50 Hz Rated voltage: 1 x 230 V Maximum current consumption: 0.28 .. 3.13 A Enclosure class (IEC 34-5): X4D Insulation class (IEC 85): F</p> <p>Others: Label: Grundfos Blueflux Energy (EEI): 0.18 Net weight: 51.4 kg Gross weight: 61.2 kg Shipping volume: 0.208 m³</p>

97924503 MAGNA3 D 80-80 F 50 Hz

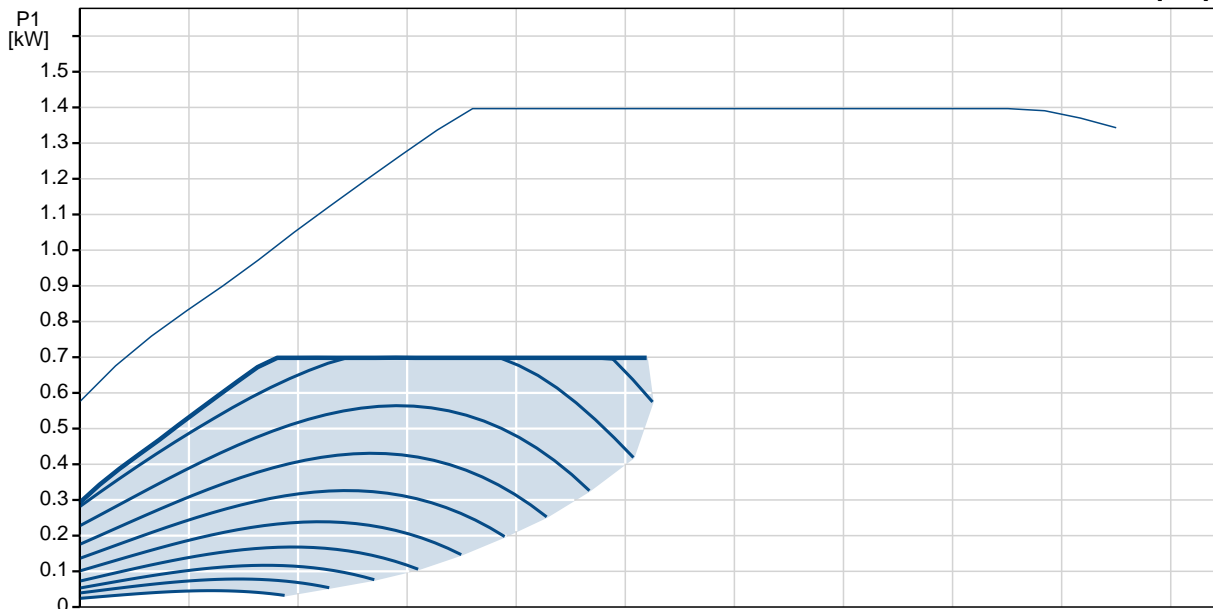
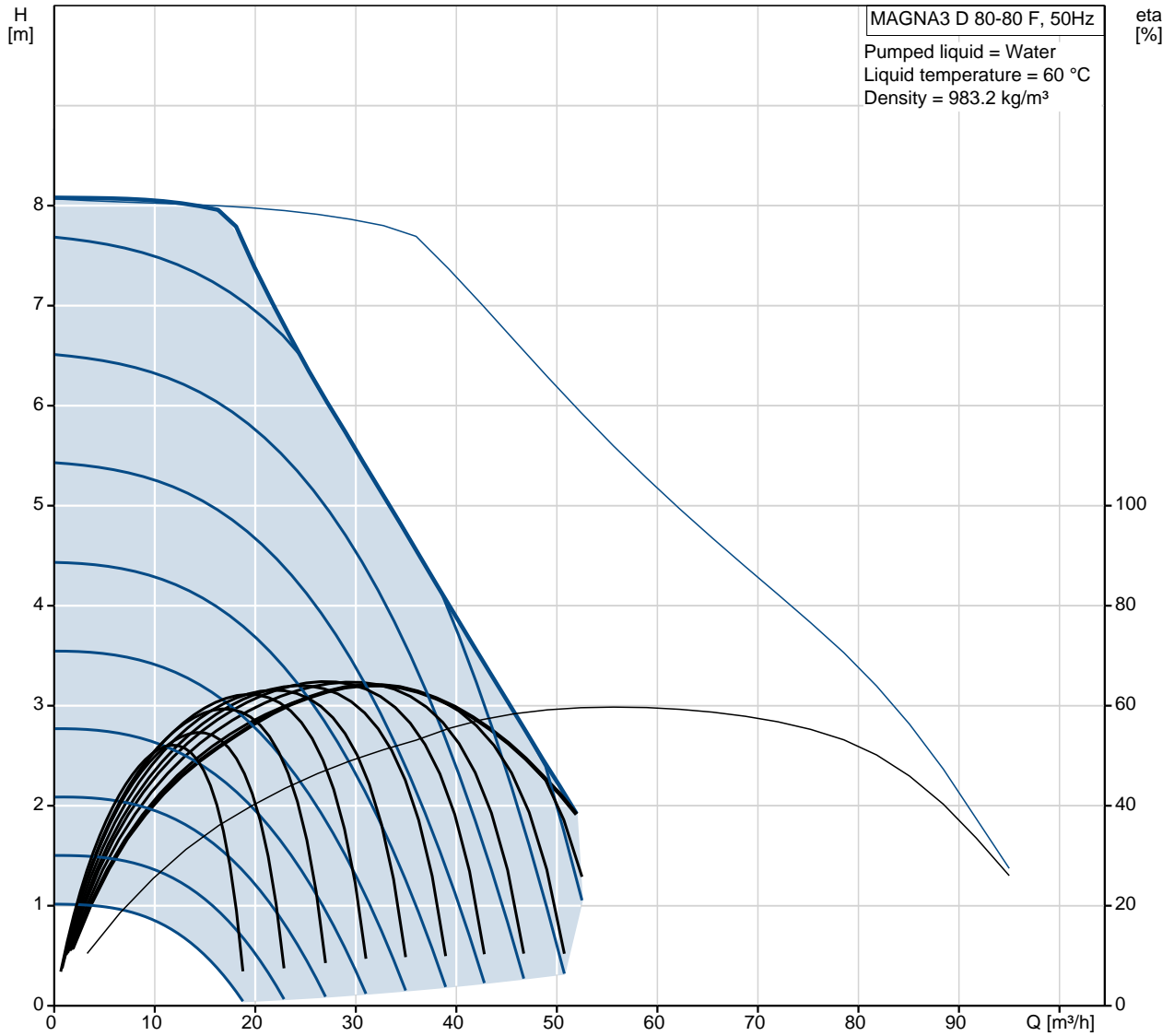

Description	Value
General information:	
Product name:	MAGNA3 D 80-80 F
Product No:	97924503
EAN number:	5710626495818
Price:	On request
Technical:	
Head max:	80 dm
TF class:	110
Approvals on nameplate:	CE,VDE,EAC
Model:	C
Materials:	
Pump housing:	Cast iron EN-GJL-250 ASTM A48-250B
Impeller:	PES 30%GF
Installation:	
Range of ambient temperature:	0 .. 40 °C
Maximum operating pressure:	6 bar
Flange standard:	DIN
Pipe connection:	DN 80
Pressure stage:	PN6
Port-to-port length:	360 mm
Liquid:	
Pumped liquid:	Water
Liquid temperature range:	-10 .. 110 °C
Liquid temp:	60 °C
Density:	983.2 kg/m ³
Electrical data:	
Power input - P1:	26 .. 712 W
Mains frequency:	50 Hz
Rated voltage:	1 x 230 V
Maximum current consumption:	0.28 .. 3.13 A
Enclosure class (IEC 34-5):	X4D
Insulation class (IEC 85):	F
Others:	
Label:	Grundfos Blueflux
Energy (EEI):	0.18
Net weight:	51.4 kg
Gross weight:	61.2 kg
Shipping volume:	0.208 m ³

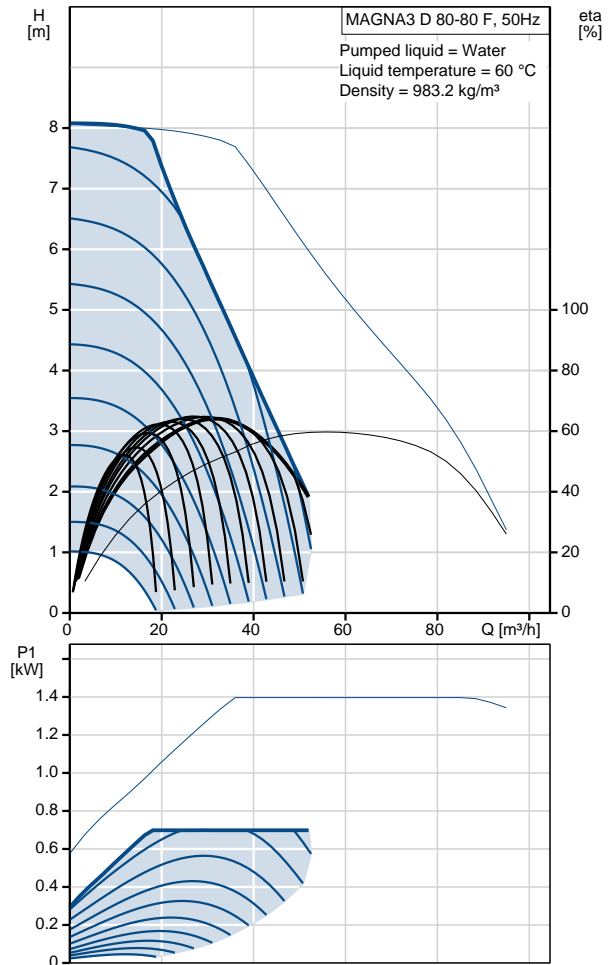

97924503 MAGNA3 D 80-80 F 50 Hz

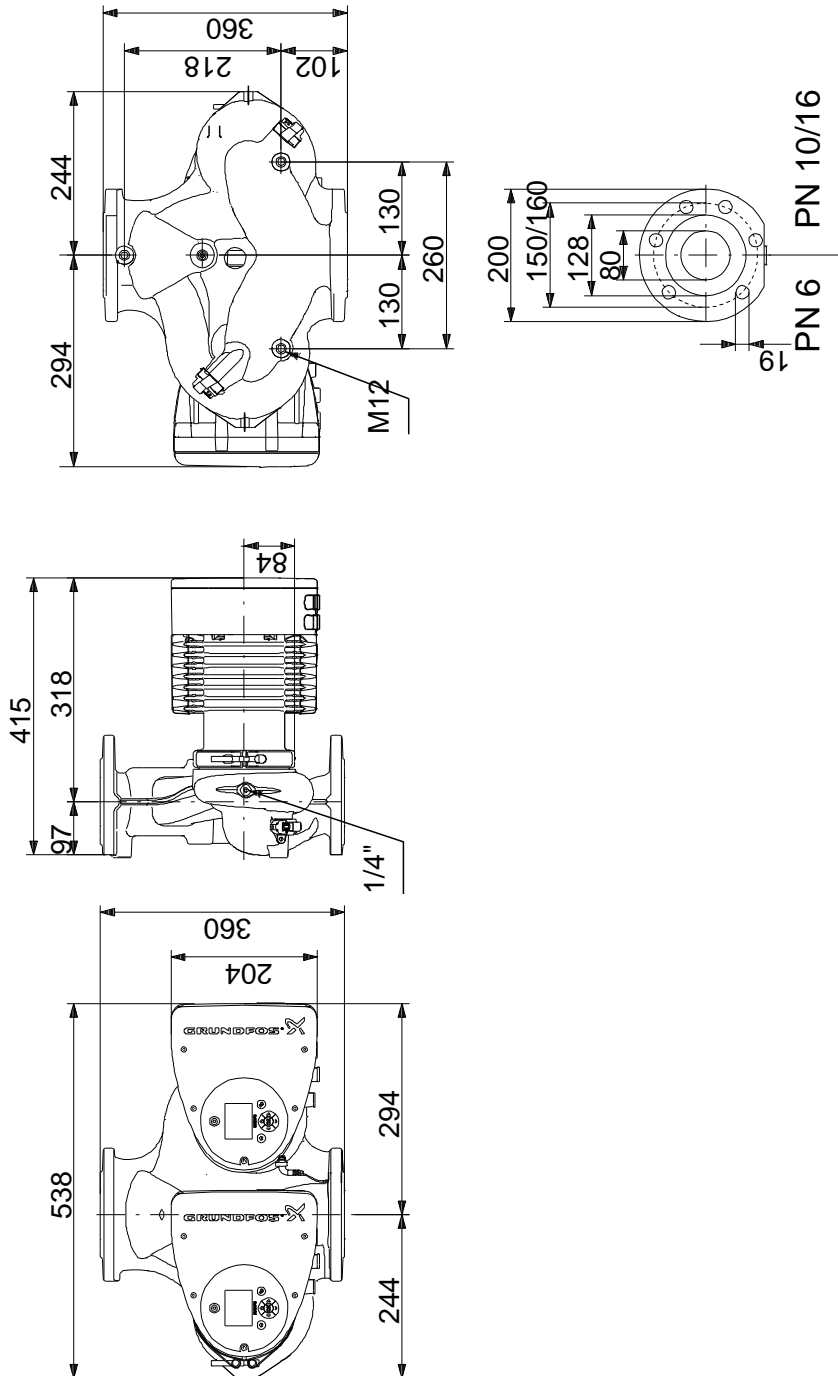

Note! All units are in [mm] unless others are stated.
Disclaimer: This simplified dimensional drawing does not show all details.

97924503 MAGNA3 D 80-80 F 50 Hz

Example of mains-connected motor with mains switch, backup fuse and additional protection

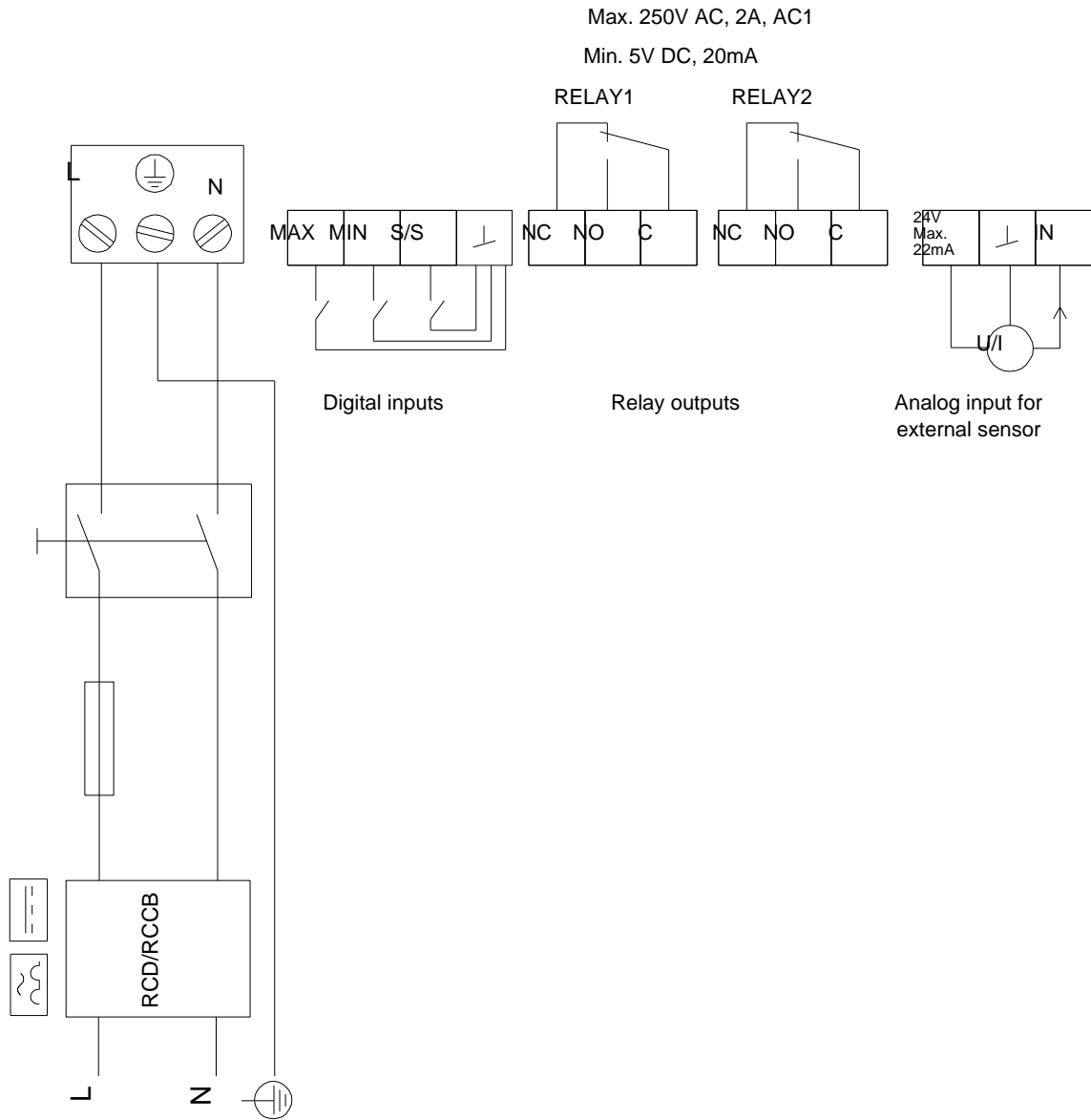

Note! All units are in [mm] unless others are stated.