

Position	Qty.	Description
	1	<p>CM3-10 A-R-I-E-AQQE</p>  <p>Product No.: 97644339</p> <p>Compact, reliable, horizontal, multistage, end-suction centrifugal pump with axial suction port and radial discharge port. Pump materials in contact with the liquid are in stainless steel. The mechanical shaft seal is a special designed, unbalanced O-ring seal. Pipework connection is via internal Whitworth pipe threads, Rp (ISO 7/1).</p> <p>The pump is fitted with a 1-phase, foot-mounted, fan-cooled asynchronous motor.</p> <p>Liquid: Pumped liquid: Water Liquid temperature range: -20 .. 120 °C Q_OpFluidTemp: 20 °C Density: 998.2 kg/m³</p> <p>Technical: Speed for pump data: 2900 rpm Rated flow: 3.1 m³/h Rated head: 69.8 m Primary shaft seal: AQQE Approvals on nameplate: CE,WRAS,ACS,TR,EAC Curve tolerance: ISO9906:2012 3B</p> <p>Materials: Pump housing: Stainless steel DIN W.-Nr. 1.4301 304 Impeller: Stainless steel DIN W.-Nr. 1.4301 AISI 304 Rubber: EPDM</p> <p>Installation: Maximum ambient temperature: 55 °C Maximum operating pressure: 10 bar Max pressure at stated temp: 10 bar / 120 °C Flange standard: WHITWORTH THREAD RP Pump inlet: Rp 1 Pump outlet: Rp 1</p> <p>Electrical data: Motor type: 90SA IE Efficiency class: NA Rated power - P2: 1.3 kW Mains frequency: 50 Hz Rated voltage: 1 x 220-240 V Service factor: 1 Rated current: 8,4-8,0 A</p>



Company name:

Created by:

Phone:

Date:

22/03/2017

Position	Qty.	Description
		Starting current: 340 % Rated speed: 2710-2710 rpm Enclosure class (IEC 34-5): IP55 Insulation class (IEC 85): F Others: Minimum efficiency index, MEI : 0,7 Net weight: 23.2 kg Gross weight: 25.7 kg

Description	Value
General information:	
Product name:	CM3-10 A-R-I-E-AQQE
Product No:	97644339
EAN number:	5710620117488
Price:	On request
Technical:	
Speed for pump data:	2900 rpm
Rated flow:	3.1 m³/h
Rated head:	69.8 m
Impellers:	10
Primary shaft seal:	AQQE
Approvals on nameplate:	CE,WRAS,ACS,TR,EAC
Curve tolerance:	ISO9906:2012 3B
Pump version:	A
Model:	A
Materials:	
Pump housing:	Stainless steel DIN W.-Nr. 1.4301 304
Impeller:	Stainless steel DIN W.-Nr. 1.4301 AISI 304
Material code:	I
Rubber:	EPDM
Code for rubber:	E
Installation:	
Maximum ambient temperature:	55 °C
Maximum operating pressure:	10 bar
Max pressure at stated temp:	10 bar / 120 °C
Flange standard:	WHITWORTH THREAD RP
Connect code:	R
Pump inlet:	Rp 1
Pump outlet:	Rp 1
Liquid:	
Pumped liquid:	Water
Liquid temperature range:	-20 .. 120 °C
Q_OpFluidTemp:	20 °C
Density:	998.2 kg/m³
Electrical data:	
Motor type:	90SA
IE Efficiency class:	NA
Rated power - P2:	1.3 kW
Mains frequency:	50 Hz
Rated voltage:	1 x 220-240 V
Service factor:	1
Rated current:	8,4-8,0 A
Starting current:	340 %
Rated speed:	2710-2710 rpm
Enclosure class (IEC 34-5):	IP55
Insulation class (IEC 85):	F
Motor protec:	TP211
Others:	
Minimum efficiency index, MEI :	0,7

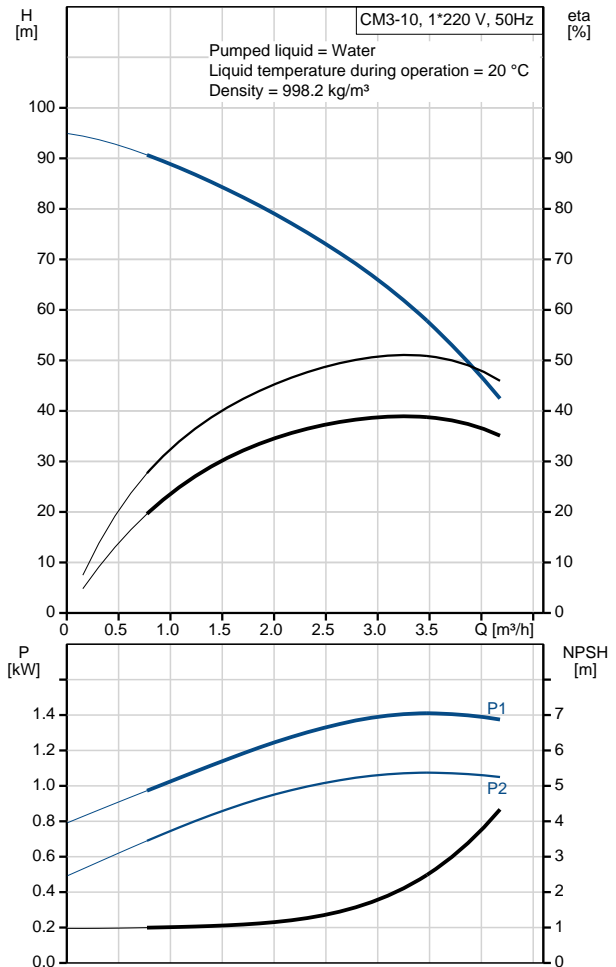



Company name:

Created by:

Phone:

Date: 22/03/2017

Description	Value
Net weight:	23.2 kg
Gross weight:	25.7 kg

97644339 CM3-10 50 Hz

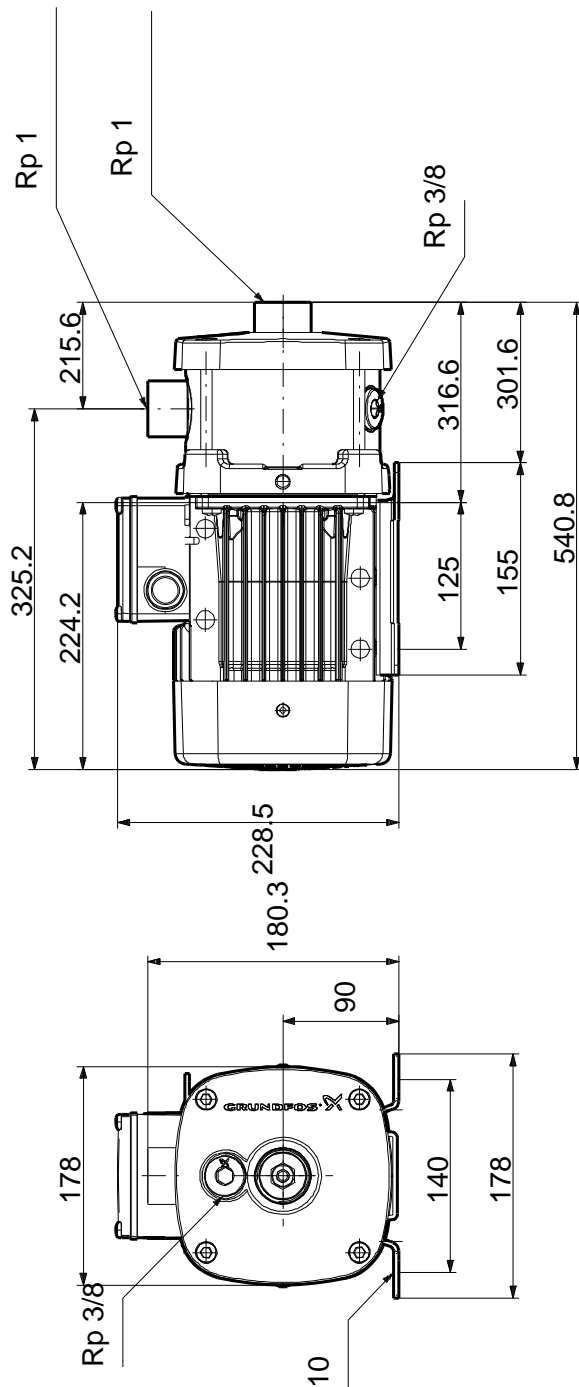

Note! All units are in [mm] unless others are stated.
Disclaimer: This simplified dimensional drawing does not show all details.

97644339 CM3-10 50 Hz

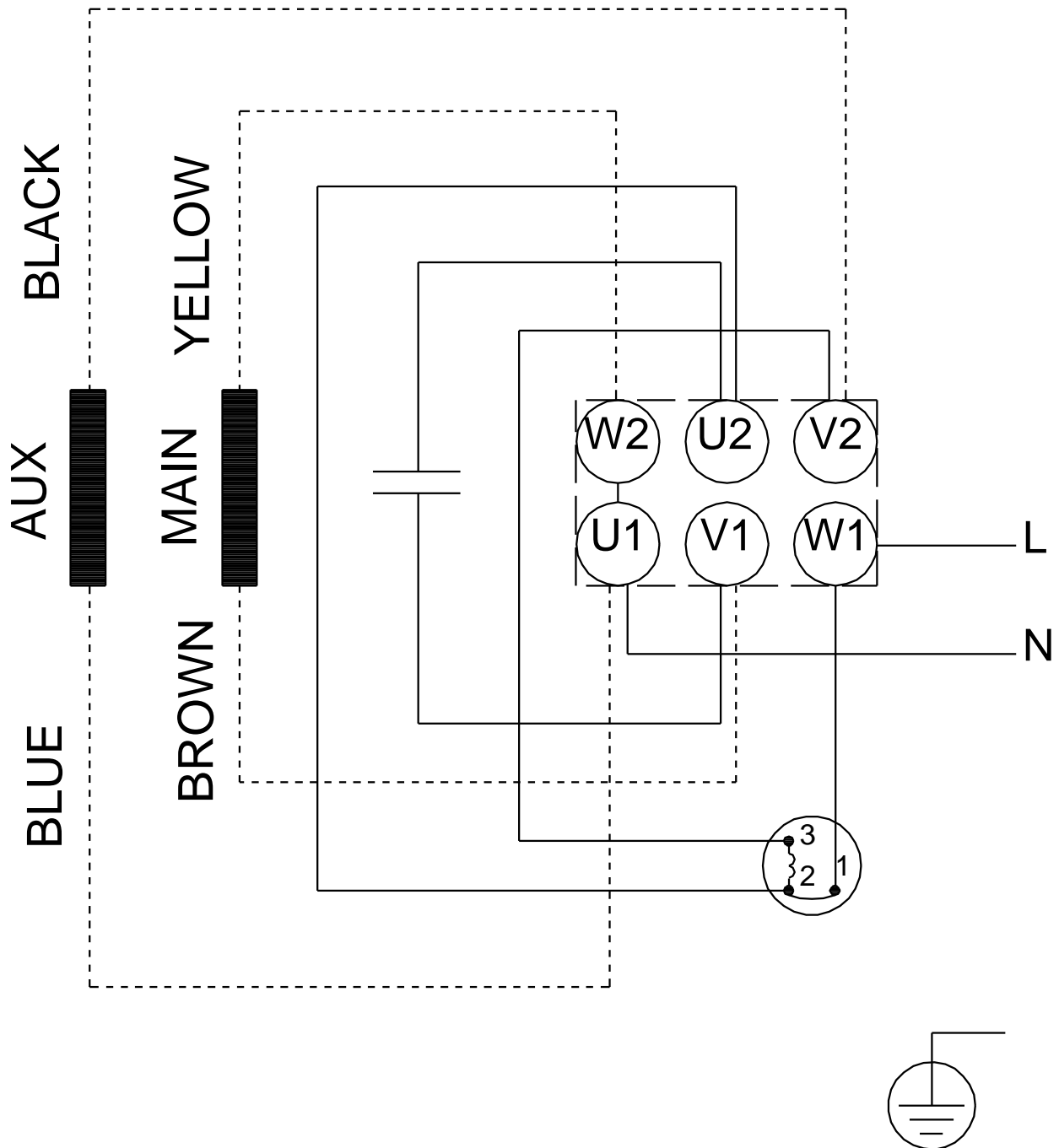

Note! All units are in [mm] unless others are stated.