

Position	Count	Description
	1	<p>CM1-9 A-R-I-E-AQQE</p>  <p>Product No.: 97644332</p> <p>Compact, reliable, horizontal, multistage, end-suction centrifugal pump with axial suction port and radial discharge port. Pump materials in contact with the liquid are in stainless steel. The mechanical shaft seal is a special designed, unbalanced O-ring seal. Pipework connection is via internal Whitworth pipe threads, Rp (ISO 7/1).</p> <p>The pump is fitted with a 3-phase, foot-mounted, fan-cooled asynchronous motor.</p> <p>Liquid: Pumped liquid: Water Liquid temperature range: -4 .. 248 °F Liquid temperature during operation: 68 °F Density: 62.29 lb/ft³</p> <p>Technical: Rated flow: 7.48 US gpm Rated head: 178.2 ft Primary shaft seal: AQQE Approvals on nameplate: CE,WRAS,ACS,TR,EAC Curve tolerance: ISO9906:2012 3B</p> <p>Materials: Pump housing: Stainless steel DIN W.-Nr. 1.4301 AISI 304 Impeller: Stainless steel DIN W.-Nr. 1.4301 AISI 304 Rubber: EPDM</p> <p>Installation: Maximum ambient temperature: 131 °F Maximum operating pressure: 145 psi Max pressure at stated temperature: 145 psi / 250 °F Flange standard: WHITWORTH THREAD RP Pump inlet: Rp 1 Pump outlet: Rp 1</p> <p>Electrical data: Motor type: 71B Rated power - P2: 0.872 HP Main frequency: 50 Hz Rated voltage: 3 x 220-240D/380-415Y V Service factor: 1 Rated current: 2,8-3,1/1,6-1,8 A Starting current: 580-620 % Rated speed: 2770-2820 rpm Enclosure class (IEC 34-5): IP55 Insulation class (IEC 85): F</p>



Company name:

Created by:

Phone:

Date:

10/4/2018

Position	Count	Description
		<p>Others: Minimum efficiency index, MEI : 0.68 Net weight: 31.8 lb Gross weight: 37.3 lb Country of origin: HU Custom tariff no.: 84137075</p>



Company name:

Created by:

Phone:

Date:

10/4/2018

97644332 CM1-9 A-R-I-E-AQQE 50 Hz

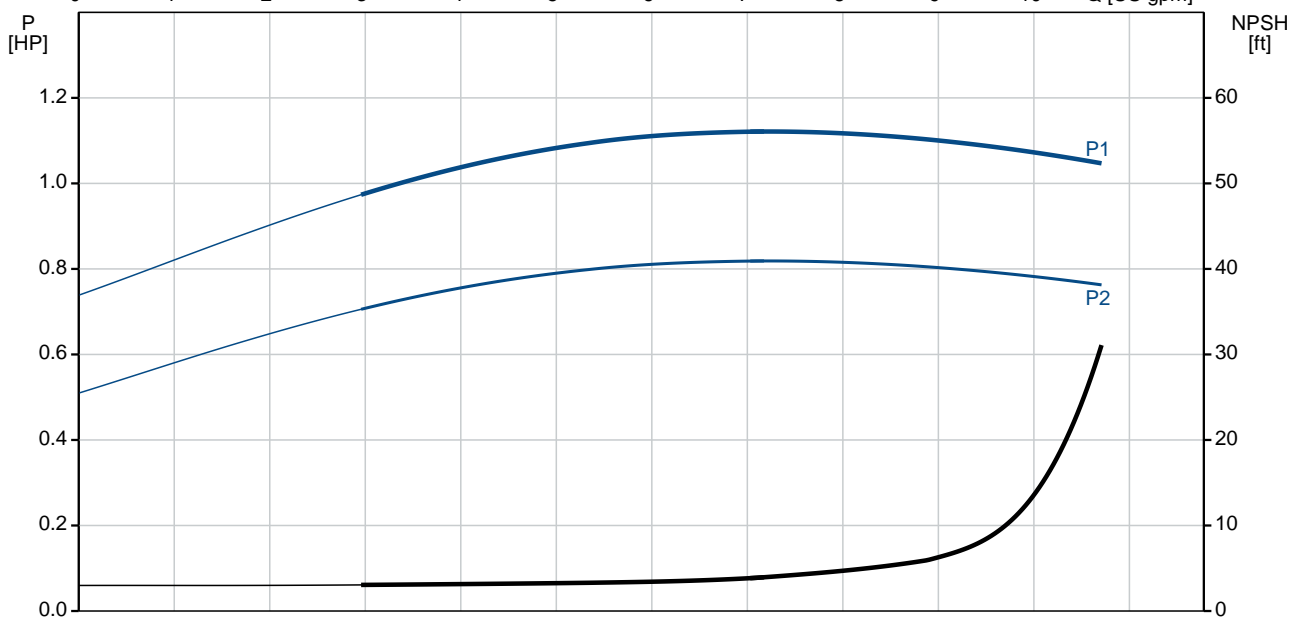
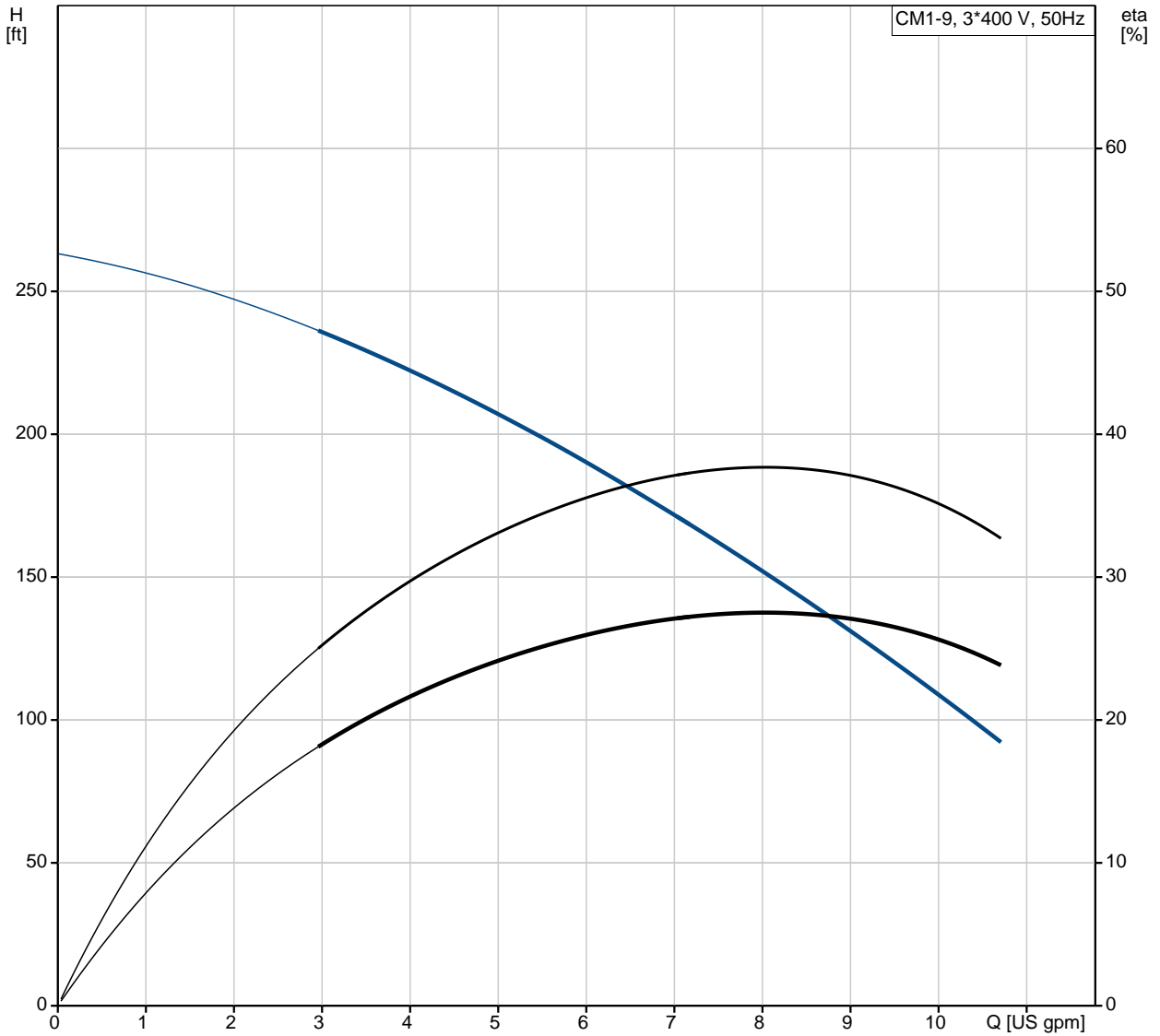

Description	Value
General information:	
Product name:	CM1-9 A-R-I-E-AQQE
Product No.:	97644332
EAN:	5710620116672
Technical:	
Rated flow:	7.48 US gpm
Rated head:	178.2 ft
Impellers:	9
Primary shaft seal:	AQQE
Approvals on nameplate:	CE,WRAS,ACS,TR,EAC
Curve tolerance:	ISO9906:2012 3B
Pump version:	A
Model:	A
Materials:	
Pump housing:	Stainless steel
	DIN W.-Nr. 1.4301
	AISI 304
Impeller:	Stainless steel
	DIN W.-Nr. 1.4301
	AISI 304
Material code:	I
Rubber:	EPDM
Code for rubber:	E
Installation:	
Maximum ambient temperature:	131 °F
Maximum operating pressure:	145 psi
Max pressure at stated temperature:	145 psi / 250 °F
Flange standard:	WHITWORTH THREAD RP
Pump inlet:	Rp 1
Pump outlet:	Rp 1
Connect code:	R
Liquid:	
Pumped liquid:	Water
Liquid temperature range:	-4 .. 248 °F
Liquid temperature during operation:	68 °F
Density:	62.29 lb/ft³
Electrical data:	
Motor type:	71B
Rated power - P2:	0.872 HP
Main frequency:	50 Hz
Rated voltage:	3 x 220-240D/380-415Y V
Service factor:	1
Rated current:	2,8-3,1/1,6-1,8 A
Starting current:	580-620 %
Rated speed:	2770-2820 rpm
Enclosure class (IEC 34-5):	IP55
Insulation class (IEC 85):	F
Motor protection:	NO
Others:	
Minimum efficiency index, MEI :	0.68
Net weight:	31.8 lb
Gross weight:	37.3 lb
Country of origin:	HU
Custom tariff no.:	84137075

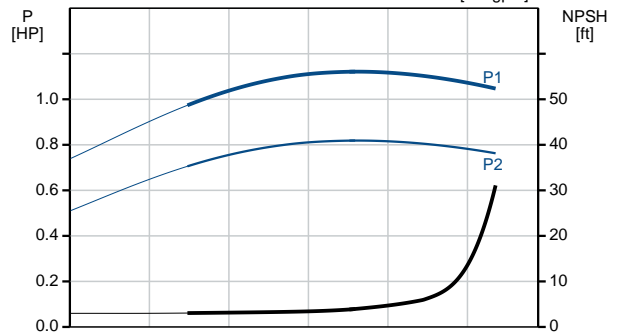
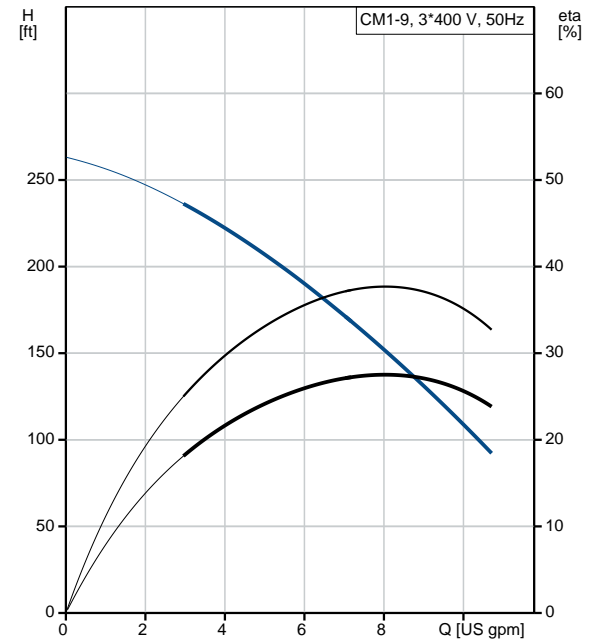

97644332 CM1-9 A-R-I-E-AQQE 50 Hz

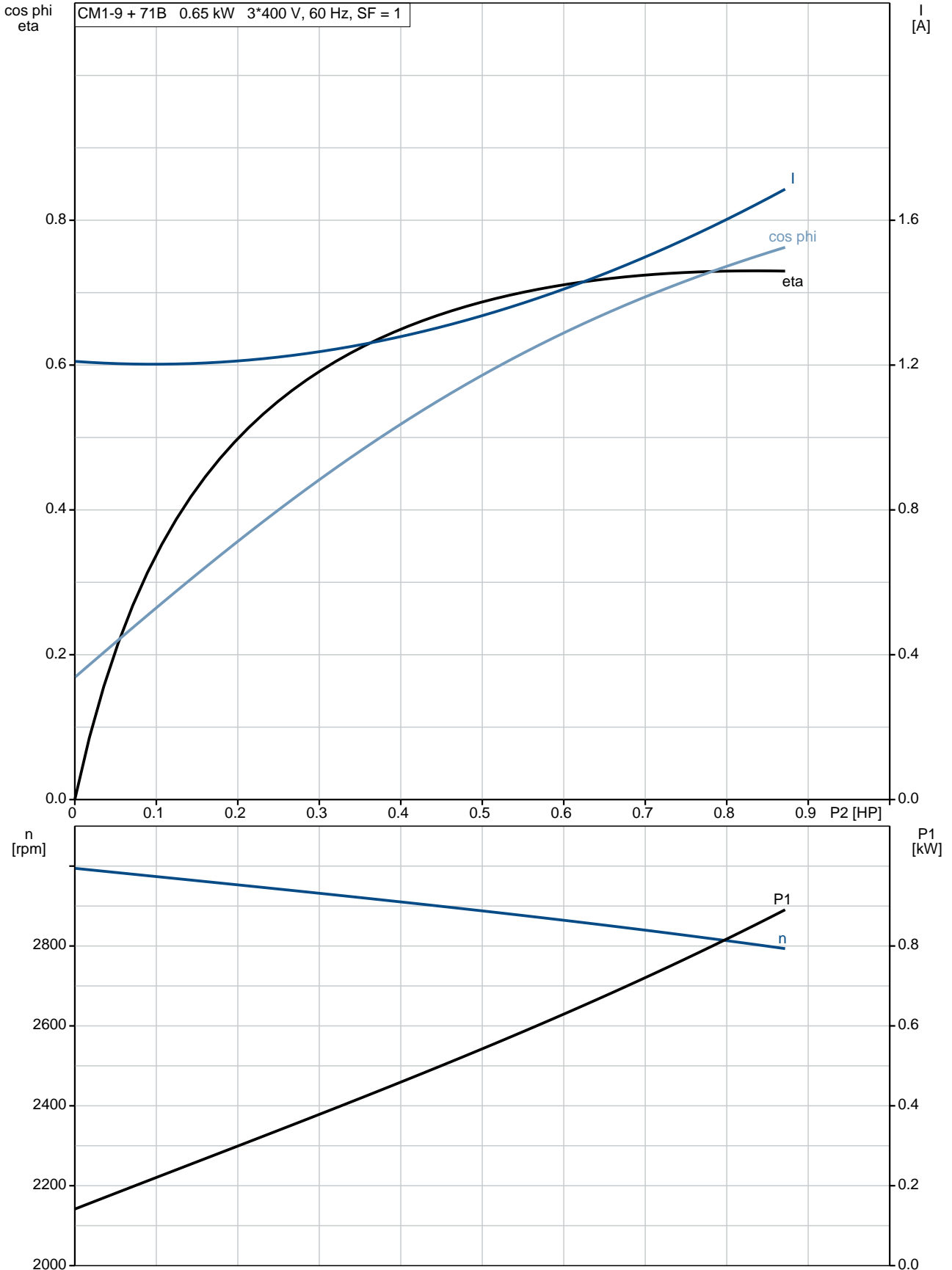

97644332 CM1-9 A-R-I-E-AQQE 50 Hz

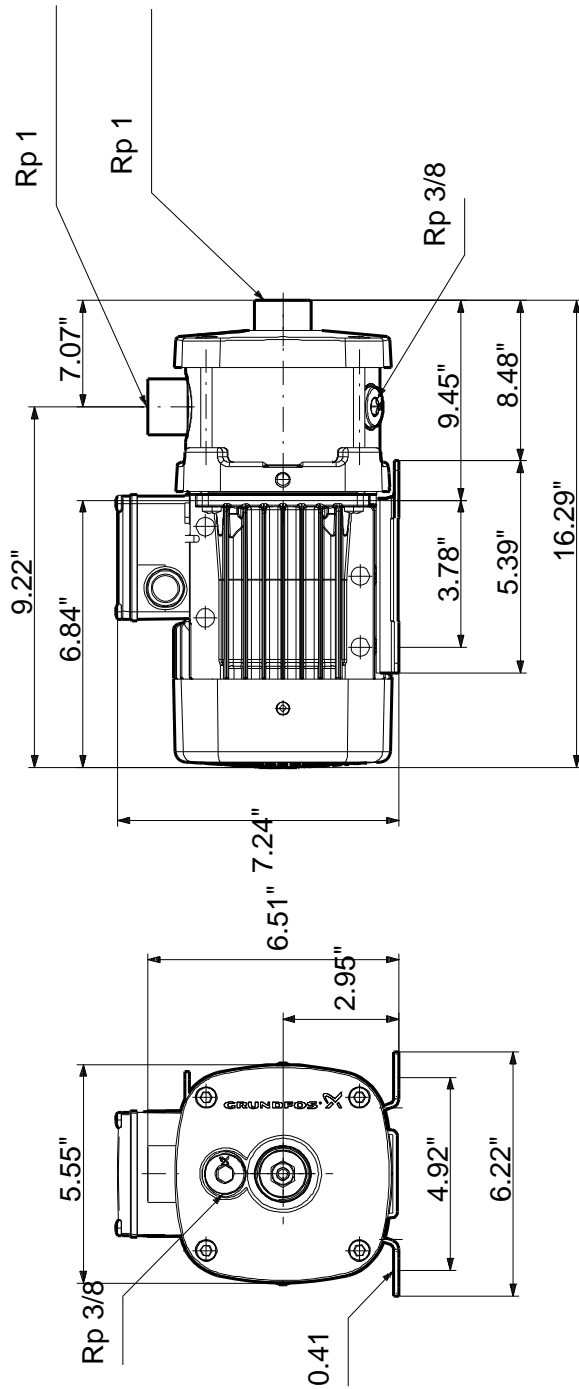

Note! All units are in [mm] unless otherwise stated.
 Disclaimer: This simplified dimensional drawing does not show all details.

97644332 CM1-9 A-R-I-E-AQQE 50 Hz



All units are [mm] unless otherwise presented.