

Position	Qty.	Description
	1	<p>CM1-8 A-R-G-E-AQQE</p>  <p>Product No.: 97516647</p> <p>Compact, reliable, horizontal, multistage, end-suction centrifugal pump with axial suction port and radial discharge port. Pump materials in contact with the liquid are in high-grade stainless steel. The mechanical shaft seal is a special designed, unbalanced O-ring seal. Pipework connection is via internal Whitworth pipe threads, Rp (ISO 7/1).</p> <p>The pump is fitted with a 3-phase, foot-mounted, fan-cooled asynchronous motor.</p> <p>Liquid: Pumped liquid: Water Liquid temperature range: -20 .. 120 °C Liquid temperature during operation: 20 °C Density: 998.2 kg/m³</p> <p>Technical: Rated flow: 1.7 m³/h Rated head: 48.3 m Primary shaft seal: AQQE Approvals on nameplate: CE,WRAS,ACS,TR,EAC Curve tolerance: ISO9906:2012 3B</p> <p>Materials: Pump housing: Stainless steel DIN W.-Nr. 1.4401 AISI 316 Impeller: Stainless steel DIN W.-Nr. 1.4401 AISI 316 Rubber: EPDM</p> <p>Installation: Maximum ambient temperature: 55 °C Maximum operating pressure: 16 bar Max pressure at stated temp: 10 bar / 120 °C 16 bar / 90 °C Flange standard: WHITWORTH THREAD RP Pump inlet: Rp 1 Pump outlet: Rp 1</p> <p>Electrical data: Motor type: 71B Rated power - P2: 0.65 kW Mains frequency: 50 Hz Rated voltage: 3 x 220-240D/380-415Y V Service factor: 1 Rated current: 2,8-3,1/1,6-1,8 A Starting current: 580-620 %</p>



Company name:

Created by:

Phone:

Date:

08/10/2018

Position	Qty.	Description
		Rated speed: 2770-2820 rpm Enclosure class (IEC 34-5): IP55 Insulation class (IEC 85): F Others: Minimum efficiency index, MEI : 0.68 Net weight: 14.4 kg Gross weight: 16.8 kg Country of origin: HU Custom tariff no.: 84137075

97516647 CM1-8 A-R-G-E-AQQE 50 Hz

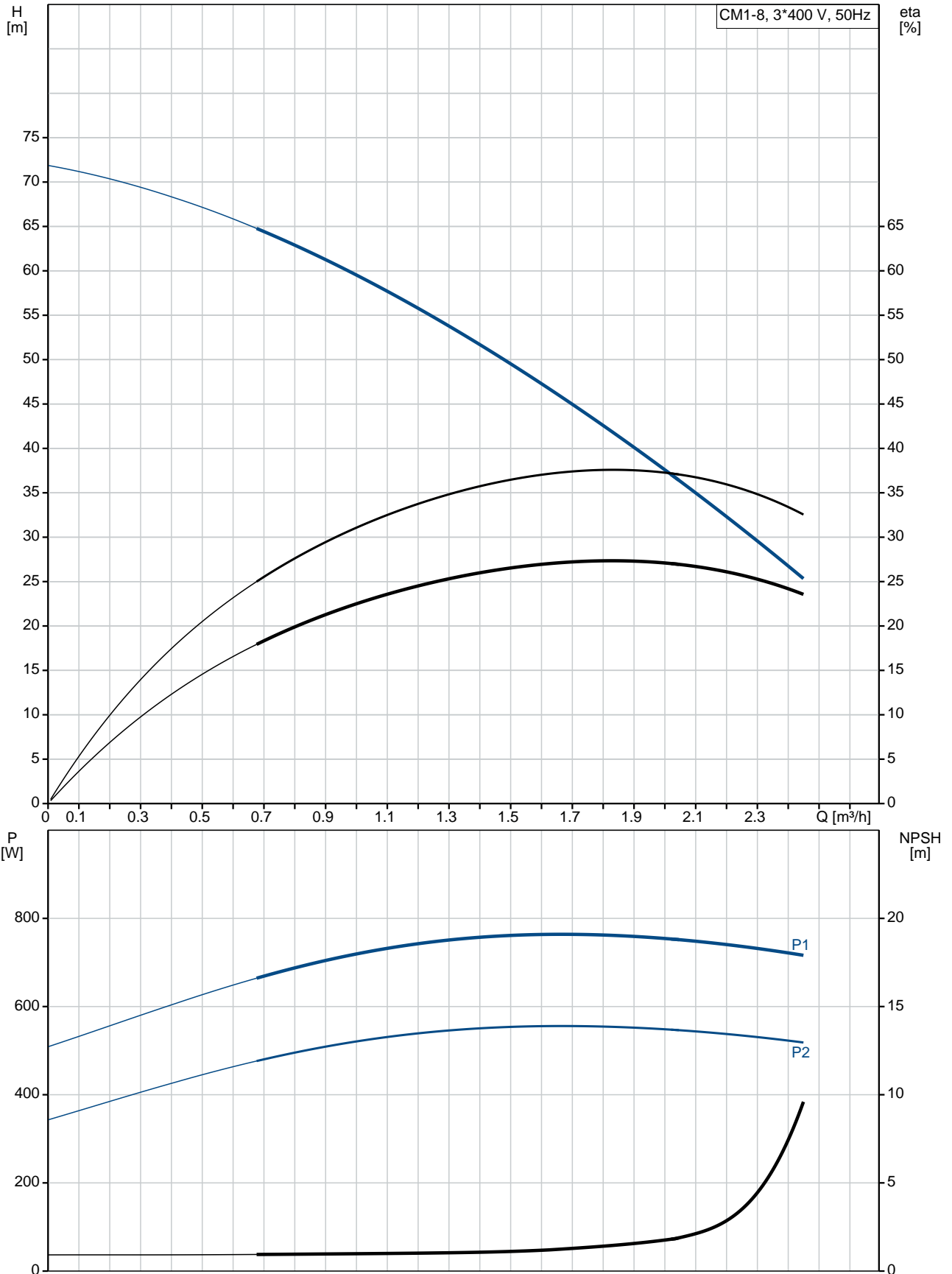

Description	Value
General information:	
Product name:	CM1-8 A-R-G-E-AQQE
Product No:	97516647
EAN number:	5700317302730
Price:	851,00 GBP
Technical:	
Rated flow:	1.7 m³/h
Rated head:	48.3 m
Impellers:	8
Primary shaft seal:	AQQE
Approvals on nameplate:	CE,WRAS,ACS,TR,EAC
Curve tolerance:	ISO9906:2012 3B
Pump version:	A
Model:	A
Materials:	
Pump housing:	Stainless steel DIN W.-Nr. 1.4401 AISI 316
Impeller:	Stainless steel DIN W.-Nr. 1.4401 AISI 316
Material code:	G
Rubber:	EPDM
Code for rubber:	E
Installation:	
Maximum ambient temperature:	55 °C
Maximum operating pressure:	16 bar
Max pressure at stated temp:	10 bar / 120 °C 16 bar / 90 °C
Flange standard:	WHITWORTH THREAD RP
Pump inlet:	Rp 1
Pump outlet:	Rp 1
Connect code:	R
Liquid:	
Pumped liquid:	Water
Liquid temperature range:	-20 .. 120 °C
Liquid temperature during operation:	20 °C
Density:	998.2 kg/m³
Electrical data:	
Motor type:	71B
Rated power - P2:	0.65 kW
Mains frequency:	50 Hz
Rated voltage:	3 x 220-240D/380-415Y V
Service factor:	1
Rated current:	2,8-3,1/1,6-1,8 A
Starting current:	580-620 %
Rated speed:	2770-2820 rpm
Enclosure class (IEC 34-5):	IP55
Insulation class (IEC 85):	F
Motor protec:	NO
Others:	
Minimum efficiency index, MEI :	0.68
Net weight:	14.4 kg
Gross weight:	16.8 kg
Country of origin:	HU
Custom tariff no.:	84137075

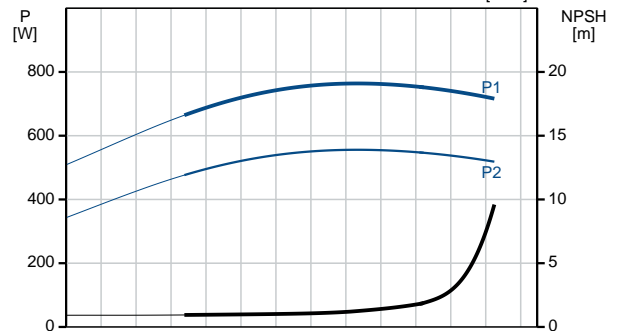
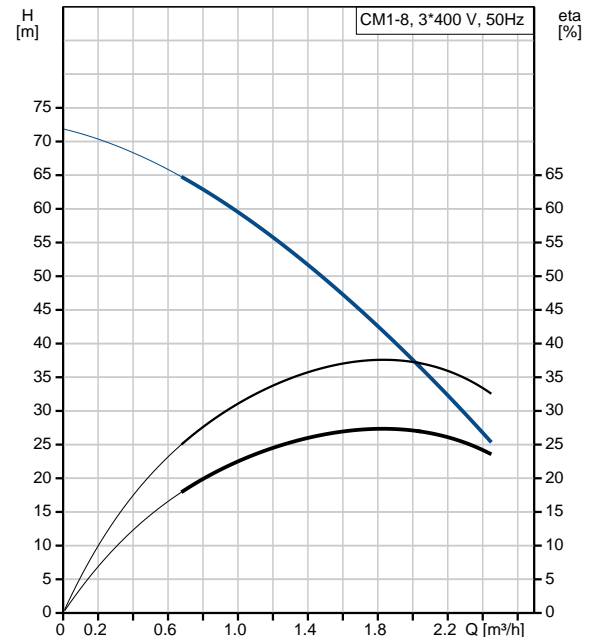

97516647 CM1-8 A-R-G-E-AQQE 50 Hz

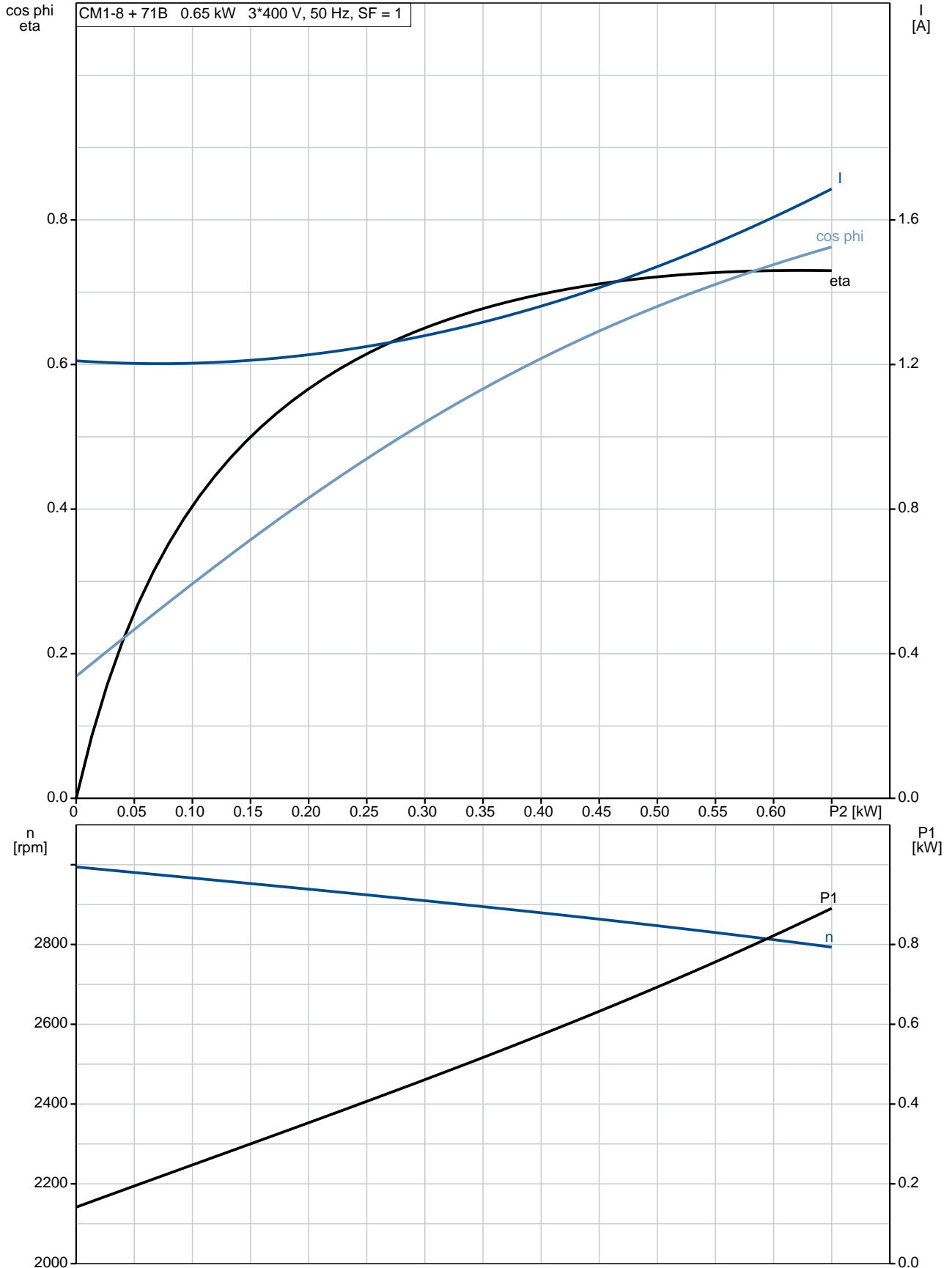

97516647 CM1-8 A-R-G-E-AQQE 50 Hz

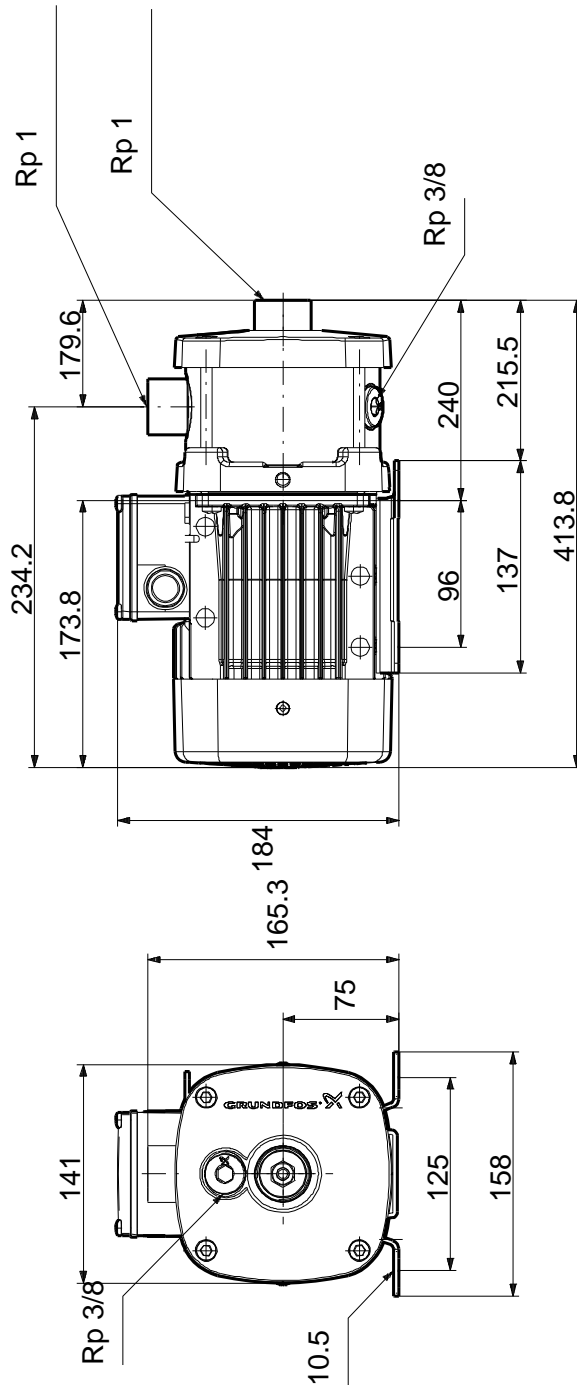

Note! All units are in [mm] unless others are stated.
 Disclaimer: This simplified dimensional drawing does not show all details.

97516647 CM1-8 A-R-G-E-AQQE 50 Hz



98.3169

Note! All units are in [mm] unless others are stated.