

Qty.	Description
1	<p data-bbox="199 336 518 369">CRN 3-8 A-FGJ-H-E-HQQE</p>  <p data-bbox="199 660 470 694">Product No.: 96533236</p> <p data-bbox="199 716 1404 817">Vertical, multistage centrifugal pump with inlet and outlet ports on same the level (inline). Pump materials in contact with the liquid are in high-grade stainless steel. A cartridge shaft seal ensures high reliability, safe handling, and easy access and service. Power transmission is via a rigid split coupling. Pipe connection is via combined DIN-ANSI-JIS flanges.</p> <p data-bbox="199 862 933 896">The pump is fitted with a 1-phase, fan-cooled asynchronous motor.</p> <p data-bbox="199 918 319 952">Controls:</p> <p data-bbox="199 952 638 985">Frequency converter: NONE</p> <p data-bbox="199 1008 295 1041">Liquid:</p> <p data-bbox="199 1041 638 1075">Pumped liquid: Water</p> <p data-bbox="199 1075 710 1108">Liquid temperature range: -20 .. 120 °C</p> <p data-bbox="199 1108 694 1142">Liquid temperature during operation: 20 °C</p> <p data-bbox="199 1142 702 1176">Density: 998.2 kg/m³</p> <p data-bbox="199 1198 327 1232">Technical:</p> <p data-bbox="199 1232 821 1265">Pump speed on which pump data are based: 2759 rpm</p> <p data-bbox="199 1265 638 1299">Rated flow: 3 m³/h</p> <p data-bbox="199 1299 638 1332">Rated head: 36.1 m</p> <p data-bbox="199 1332 638 1366">Pump orientation: Vertical</p> <p data-bbox="199 1366 638 1400">Shaft seal arrangement: Single</p> <p data-bbox="199 1400 638 1433">Code for shaft seal: HQQE</p> <p data-bbox="199 1433 726 1467">Approvals on nameplate: CE, EAC, ACS</p> <p data-bbox="199 1467 766 1500">Curve tolerance: ISO9906:2012 3B</p> <p data-bbox="199 1523 327 1556">Materials:</p> <p data-bbox="199 1556 726 1590">Base: Stainless steel</p> <p data-bbox="566 1590 686 1624">EN 1.4408</p> <p data-bbox="566 1624 662 1657">AISI 316</p> <p data-bbox="199 1657 726 1691">Impeller: Stainless steel</p> <p data-bbox="566 1691 686 1724">EN 1.4401</p> <p data-bbox="566 1724 662 1758">AISI 316</p> <p data-bbox="199 1758 614 1792">Bearing: SIC</p> <p data-bbox="199 1814 343 1848">Installation:</p> <p data-bbox="199 1848 630 1881">Maximum ambient temperature: 40 °C</p> <p data-bbox="199 1881 638 1915">Maximum operating pressure: 25 bar</p> <p data-bbox="199 1915 742 1948">Max pressure at stated temp: 25 bar / 120 °C</p> <p data-bbox="566 1948 742 1982">25 bar / -20 °C</p> <p data-bbox="199 1982 742 2016">Type of connection: DIN / ANSI / JIS</p> <p data-bbox="199 2016 678 2049">Size of inlet connection: DN 25/32</p> <p data-bbox="566 2049 678 2083">1 1/4 inch</p> <p data-bbox="199 2083 678 2116">Size of outlet connection: DN 25/32</p> <p data-bbox="566 2116 678 2150">1 1/4 inch</p> <p data-bbox="199 2150 686 2184">Pressure rating for pipe connection: PN 25</p> <p data-bbox="199 2184 638 2217">Flange rating inlet: 300 lb</p>

Qty.	Description
	<p>Flange size for motor: FT100</p> <p>Electrical data:</p> <p>Motor standard: IEC</p> <p>Motor type: 80B</p> <p>Rated power - P2: 0.75 kW</p> <p>Power (P2) required by pump: 0.75 kW</p> <p>Mains frequency: 50 Hz</p> <p>Rated voltage: 1 x 220-230/240 V</p> <p>Rated current: 5.10/4.75 A</p> <p>Starting current: 300 %</p> <p>Cos phi - power factor: 0.99</p> <p>Rated speed: 2780 rpm</p> <p>Efficiency: 72.1%</p> <p>Motor efficiency at full load: 72.1 %</p> <p>Number of poles: 2</p> <p>Enclosure class (IEC 34-5): 55 Dust/Jetting</p> <p>Insulation class (IEC 85): F</p> <p>Others:</p> <p>Minimum efficiency index, MEI $\hat{\alpha}\%$: 0.70</p> <p>Net weight: 25.6 kg</p> <p>Gross weight: 28 kg</p> <p>Shipping volume: 0.08 m³</p> <p>Country of origin: GB</p> <p>Custom tariff no.: 84137075</p>

96533236 CRN 3-8 A-FGJ-H-E-HQQE 50 Hz

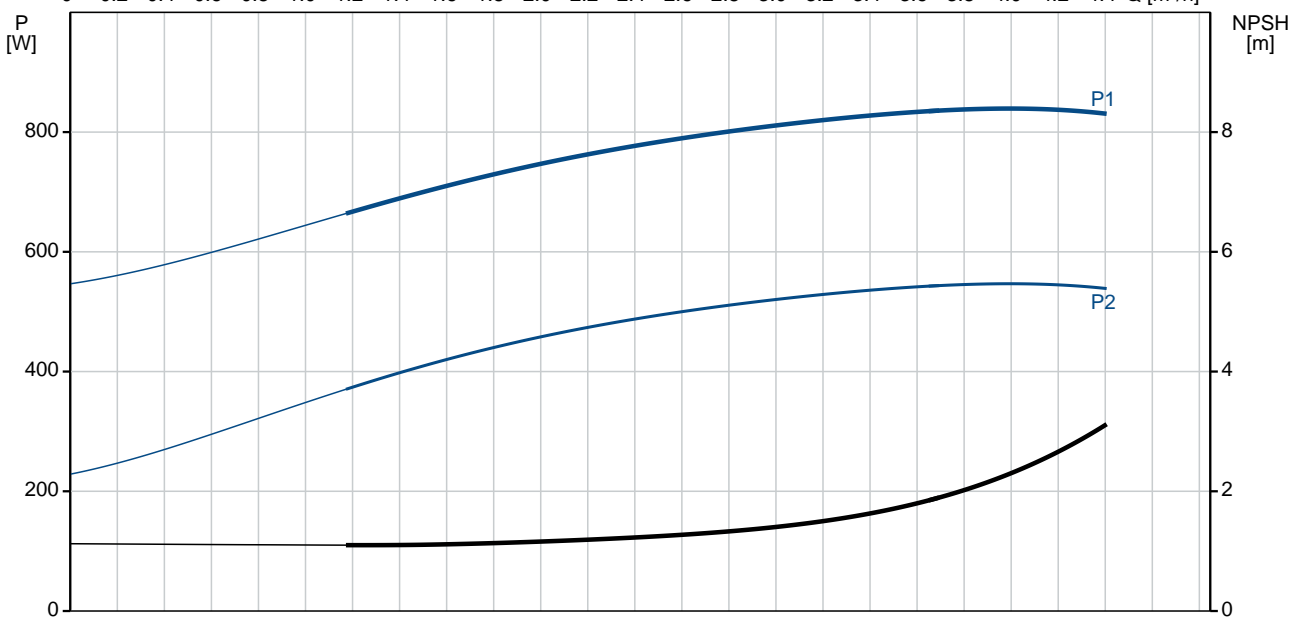
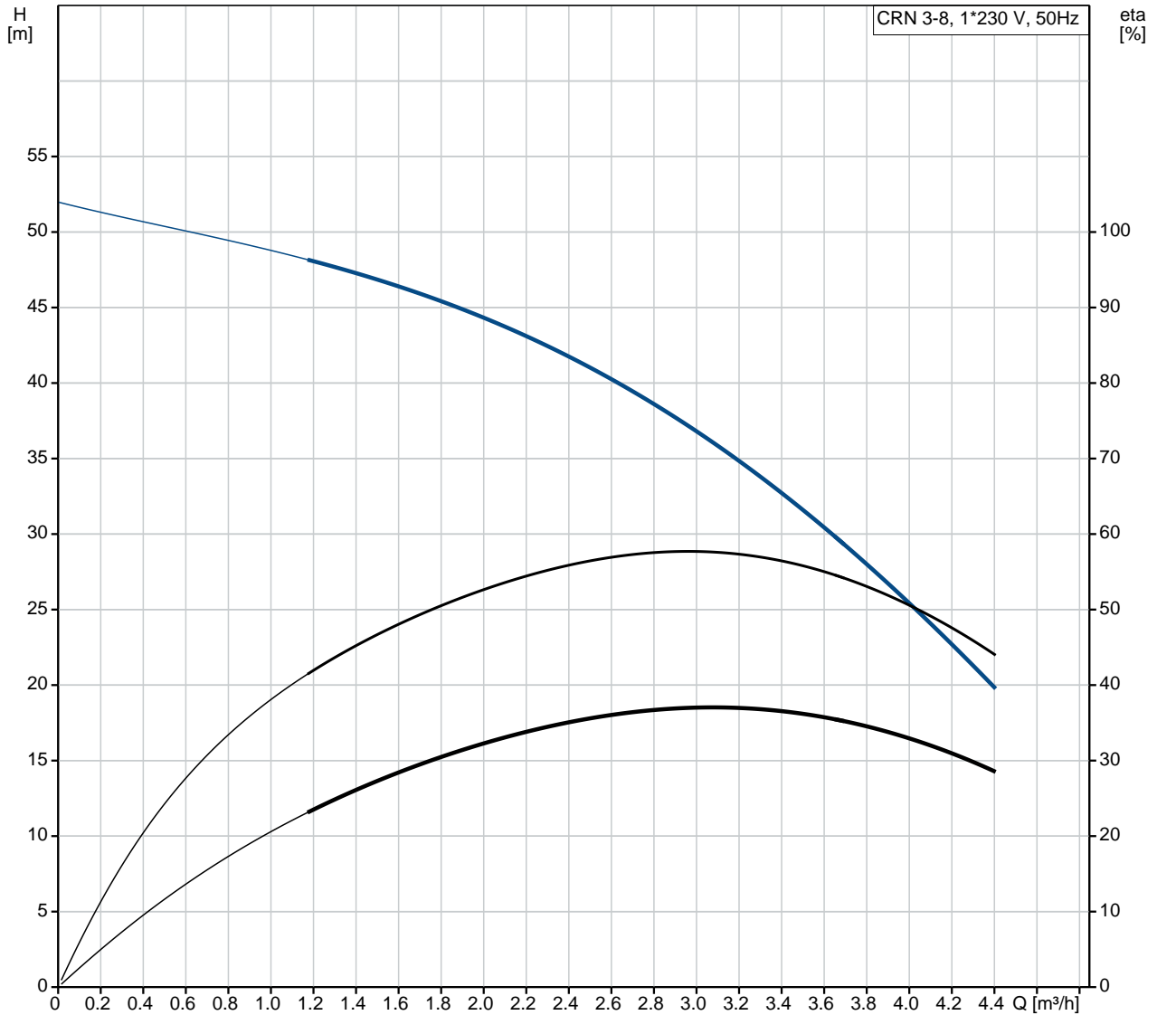

Description	Value
-------------	-------

General information:

Product name: CRN 3-8
 A-FGJ-H-E-HQQE
 Product No: 96533236
 EAN number: 5700397437025
 Price: 1.224,00 GBP

Technical:

Pump speed on which pump data are based: 2759 rpm
 Rated flow: 3 m³/h
 Rated head: 36.1 m
 Head max: 51.7 m
 Stages: 8
 Impellers: 8
 Number of reduced-diameter impellers: 0
 Low NPSH: N
 Pump orientation: Vertical
 Shaft seal arrangement: Single
 Code for shaft seal: HQQE
 Approvals on nameplate: CE, EAC, ACS
 Curve tolerance: ISO9906:2012 3B
 Pump version: A
 Model: A

Materials:

Base: Stainless steel
 EN 1.4408
 AISI 316
 Impeller: Stainless steel
 EN 1.4401
 AISI 316

Material code: H

Code for rubber: E

Bearing: SIC

Installation:

Maximum ambient temperature: 40 °C
 Maximum operating pressure: 25 bar
 Max pressure at stated temp: 25 bar / 120 °C
 25 bar / -20 °C

Type of connection: DIN / ANSI / JIS

Size of inlet connection: DN 25/32
 1 1/4 inch

Size of outlet connection: DN 25/32
 1 1/4 inch

Pressure rating for pipe connection: PN 25

Flange rating inlet: 300 lb

Flange size for motor: FT100

Connect code: FGJ

Liquid:

Pumped liquid: Water
 Liquid temperature range: -20 .. 120 °C
 Liquid temperature during operation: 20 °C
 Density: 998.2 kg/m³

Electrical data:

Motor standard: IEC
 Motor type: 80B
 Rated power - P2: 0.75 kW
 Power (P2) required by pump: 0.75 kW
 Mains frequency: 50 Hz
 Rated voltage: 1 x 220-230/240 V

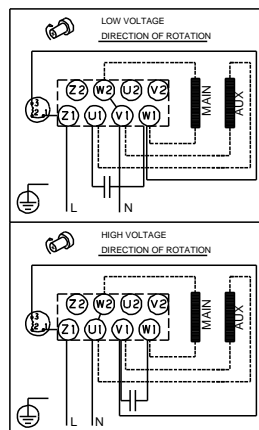
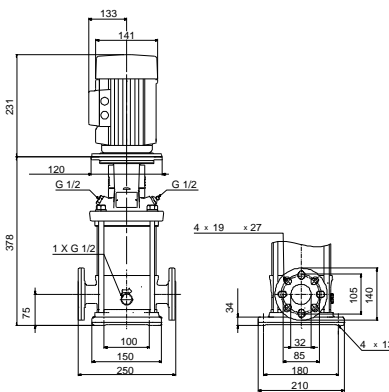
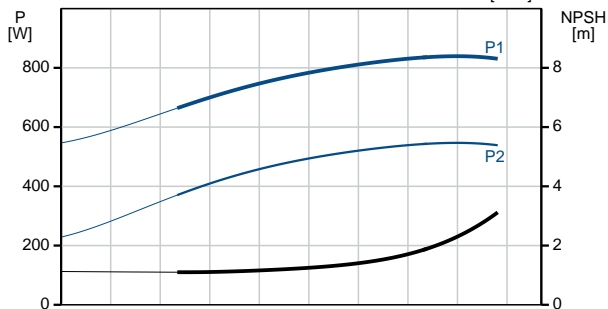
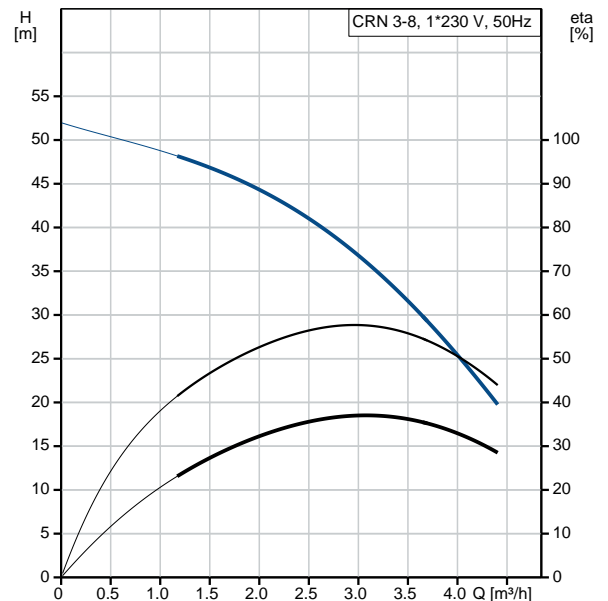



Company name:

Created by:

Phone:

Date:

07/03/2019

Description	Value
Rated current:	5.10/4.75 A
Starting current:	300 %
Cos phi - power factor:	0.99
Rated speed:	2780 rpm
Efficiency:	72.1%
Motor efficiency at full load:	72.1 %
Number of poles:	2
Enclosure class (IEC 34-5):	55 Dust/Jetting
Insulation class (IEC 85):	F
Motor protec:	PTO
Motor No:	85215104
Controls:	
Frequency converter:	NONE
Others:	
Minimum efficiency index, MEI η_{min} :	0.70
Net weight:	25.6 kg
Gross weight:	28 kg
Shipping volume:	0.08 m ³
Sales region:	Great Britain
Country of origin:	GB
Custom tariff no.:	84137075

96533236 CRN 3-8 A-FGJ-H-E-HQQE 50 Hz

