

Qty.	Description
1	<p data-bbox="199 338 497 367">CRN 1S-3 A-P-A-E-HQQE</p>  <p data-bbox="199 660 467 689">Product No.: 96532147</p> <p data-bbox="199 719 1380 797">Vertical, multistage centrifugal pump with inlet and outlet ports on same the level (inline). Pump materials in contact with the liquid are in high-grade stainless steel. Power transmission is via a rigid split coupling. Pipe connection is via PJE (Victaulic®) couplings.</p> <p data-bbox="199 835 935 864">The pump is fitted with a 1-phase, fan-cooled asynchronous motor.</p> <p data-bbox="199 896 316 925">Controls:</p> <p data-bbox="199 925 638 954">Frequency converter: NONE</p> <p data-bbox="199 985 287 1014">Liquid:</p> <p data-bbox="199 1014 707 1133">Pumped liquid: Water Liquid temperature range: -20 .. 120 °C Liquid temperature during operation: 20 °C Density: 998.2 kg/m³</p> <p data-bbox="199 1164 327 1193">Technical:</p> <p data-bbox="199 1193 821 1429">Pump speed on which pump data are based: 2757 rpm Rated flow: 0.9 m³/h Rated head: 14.6 m Pump orientation: Vertical Shaft seal arrangement: Single Code for shaft seal: HQQE Approvals on nameplate: CE, EAC, ACS Curve tolerance: ISO9906:2012 3B</p> <p data-bbox="199 1460 319 1489">Materials:</p> <p data-bbox="199 1489 727 1697">Base: Stainless steel EN 1.4408 AISI 316 Impeller: Stainless steel EN 1.4401 AISI 316 Bearing: SIC</p> <p data-bbox="199 1729 343 1758">Installation:</p> <p data-bbox="199 1758 742 2085">Maximum ambient temperature: 40 °C Maximum operating pressure: 25 bar Max pressure at stated temp: 25 bar / 120 °C 25 bar / -20 °C Type of connection: PJE Size of inlet connection: DN 32 1 1/4 inch Size of outlet connection: DN 32 1 1/4 inch Pressure rating for pipe connection: PN 50 Flange size for motor: FT85</p>

Qty.	Description
------	-------------

Electrical data:

Motor standard:	IEC
Motor type:	71B
Rated power - P2:	0.37 kW
Power (P2) required by pump:	0.37 kW
Mains frequency:	50 Hz
Rated voltage:	1 x 220-230/240 V
Rated current:	2.95/2.70 A
Starting current:	280 %
Cos phi - power factor:	0.99
Rated speed:	2770 rpm
Motor efficiency at full load:	60.0-56.0 %
Number of poles:	2
Enclosure class (IEC 34-5):	55 Dust/Jetting
Insulation class (IEC 85):	F

Others:

Minimum efficiency index, MEI η_{min} :	0.54
Net weight:	17.3 kg
Gross weight:	19.9 kg
Shipping volume:	0.054 m ³
Country of origin:	GB
Custom tariff no.:	84137075

96532147 CRN 1S-3 A-P-A-E-HQQE 50 Hz

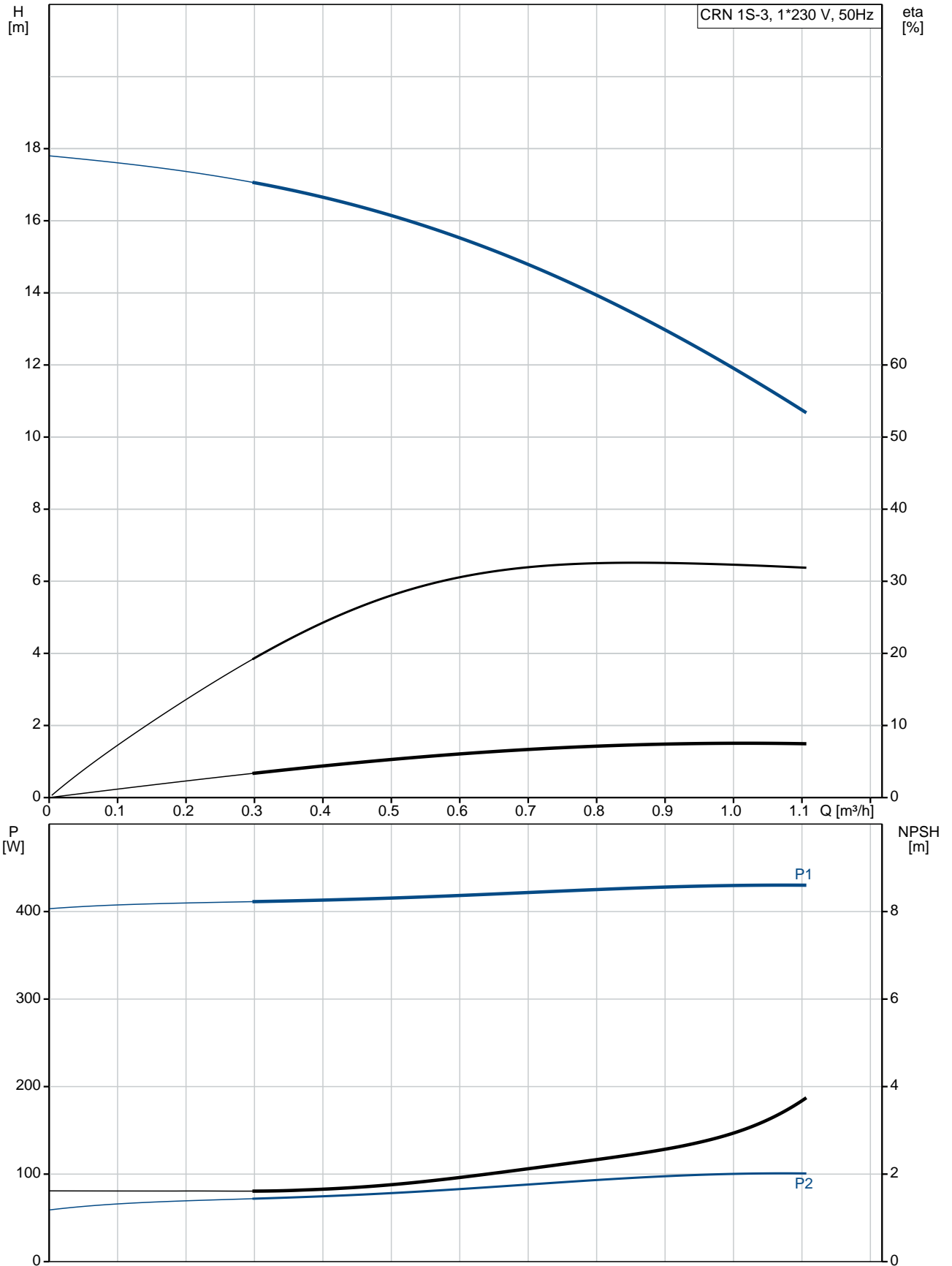

Description	Value
General information:	
Product name:	CRN 1S-3 A-P-A-E-HQQE
Product No:	96532147
EAN number:	5700397364970
Price:	769,00 GBP
Technical:	
Pump speed on which pump data are based:	2757 rpm
Rated flow:	0.9 m³/h
Rated head:	14.6 m
Head max:	18.2 m
Stages:	3
Impellers:	3
Number of reduced-diameter impellers:	0
Low NPSH:	N
Pump orientation:	Vertical
Shaft seal arrangement:	Single
Code for shaft seal:	HQQE
Approvals on nameplate:	CE, EAC, ACS
Curve tolerance:	ISO9906:2012 3B
Pump version:	A
Model:	A
Materials:	
Base:	Stainless steel EN 1.4408 AISI 316
Impeller:	Stainless steel EN 1.4401 AISI 316
Material code:	A
Code for rubber:	E
Bearing:	SIC
Installation:	
Maximum ambient temperature:	40 °C
Maximum operating pressure:	25 bar
Max pressure at stated temp:	25 bar / 120 °C 25 bar / -20 °C
Type of connection:	PJE
Size of inlet connection:	DN 32 1 1/4 inch
Size of outlet connection:	DN 32 1 1/4 inch
Pressure rating for pipe connection:	PN 50
Flange size for motor:	FT85
Connect code:	P
Liquid:	
Pumped liquid:	Water
Liquid temperature range:	-20 .. 120 °C
Liquid temperature during operation:	20 °C
Density:	998.2 kg/m³
Electrical data:	
Motor standard:	IEC
Motor type:	71B
Rated power - P2:	0.37 kW
Power (P2) required by pump:	0.37 kW
Mains frequency:	50 Hz
Rated voltage:	1 x 220-230/240 V
Rated current:	2.95/2.70 A

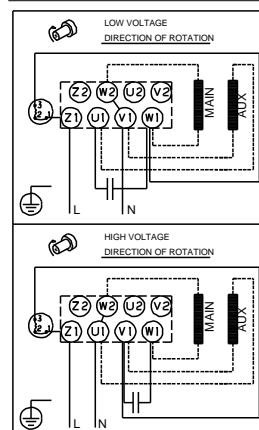
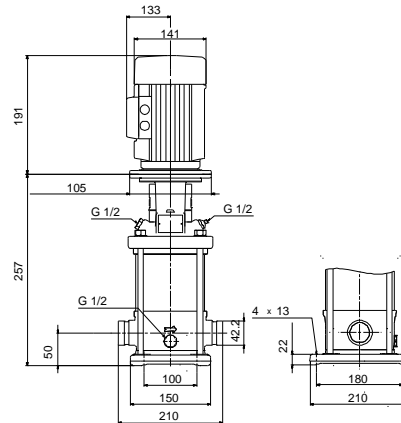
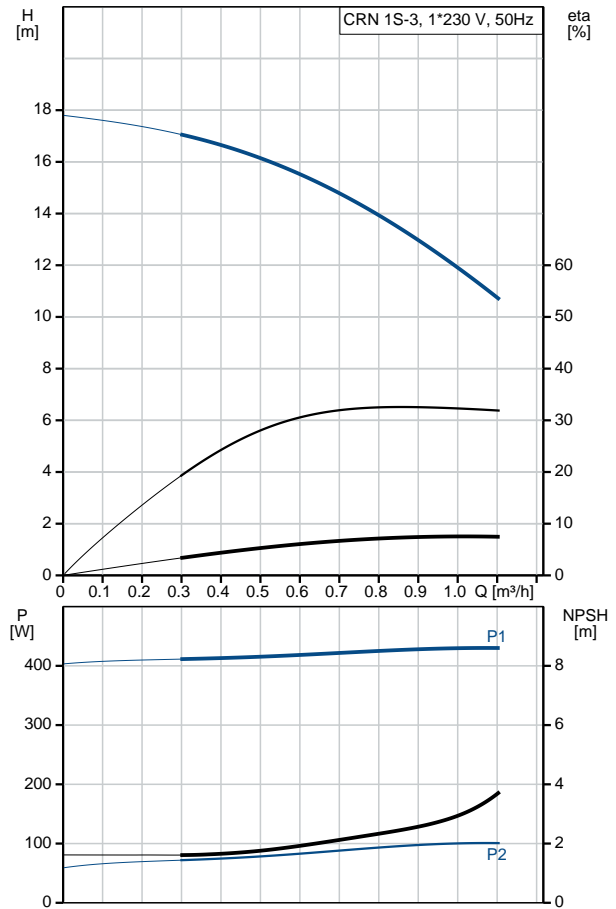



Company name:

Created by:

Phone:

Date:

07/03/2019

Description	Value
Starting current:	280 %
Cos phi - power factor:	0.99
Rated speed:	2770 rpm
Motor efficiency at full load:	60.0-56.0 %
Number of poles:	2
Enclosure class (IEC 34-5):	55 Dust/Jetting
Insulation class (IEC 85):	F
Motor protec:	PTO
Motor No:	85215102
Controls:	
Frequency converter:	NONE
Others:	
Minimum efficiency index, MEI %:	0.54
Net weight:	17.3 kg
Gross weight:	19.9 kg
Shipping volume:	0.054 m ³
Sales region:	GB
Country of origin:	GB
Custom tariff no.:	84137075

96532147 CRN 1S-3 A-P-A-E-HQQE 50 Hz

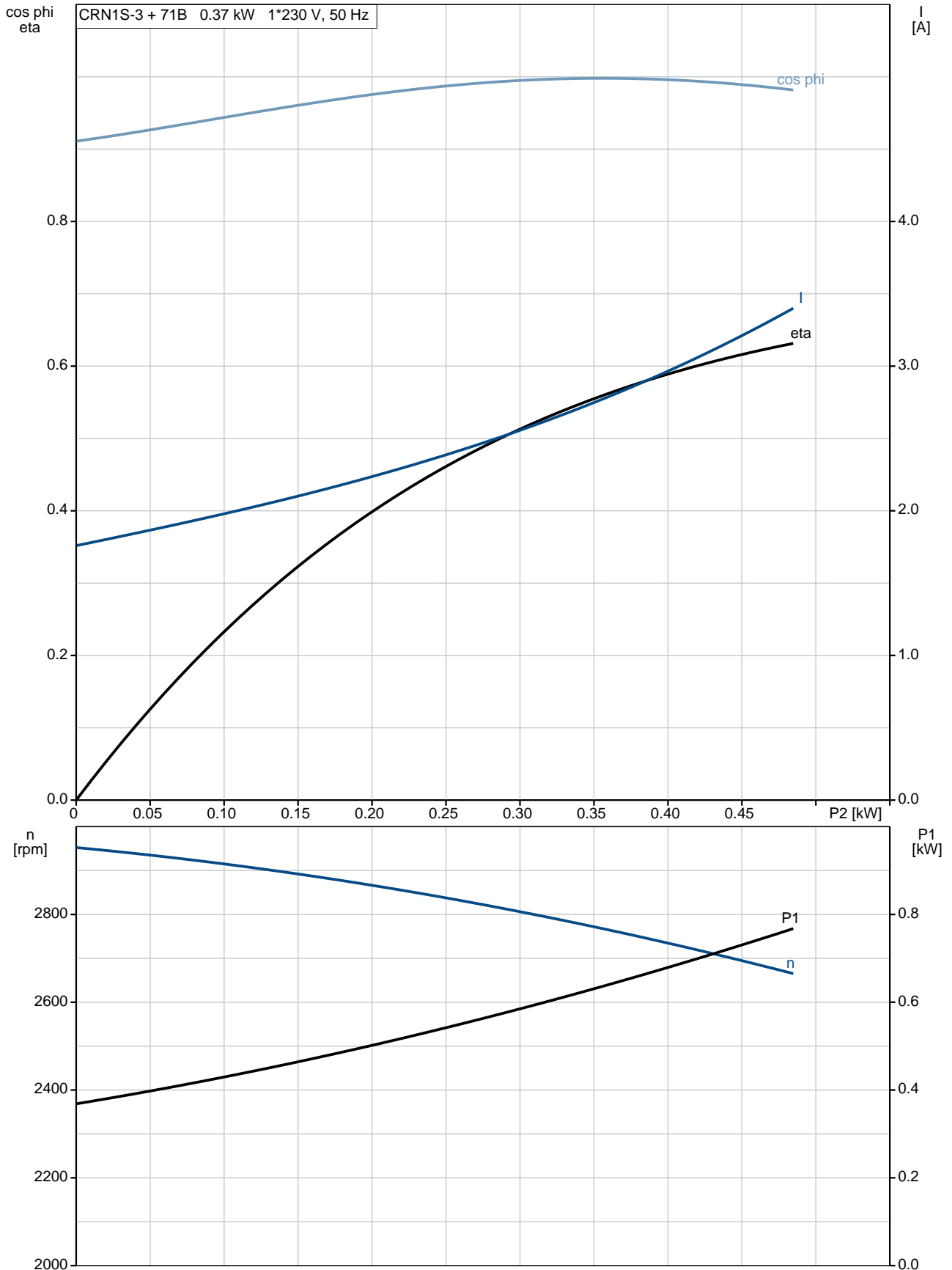

96532147 CRN 1S-3 A-P-A-E-HQQE 50 Hz

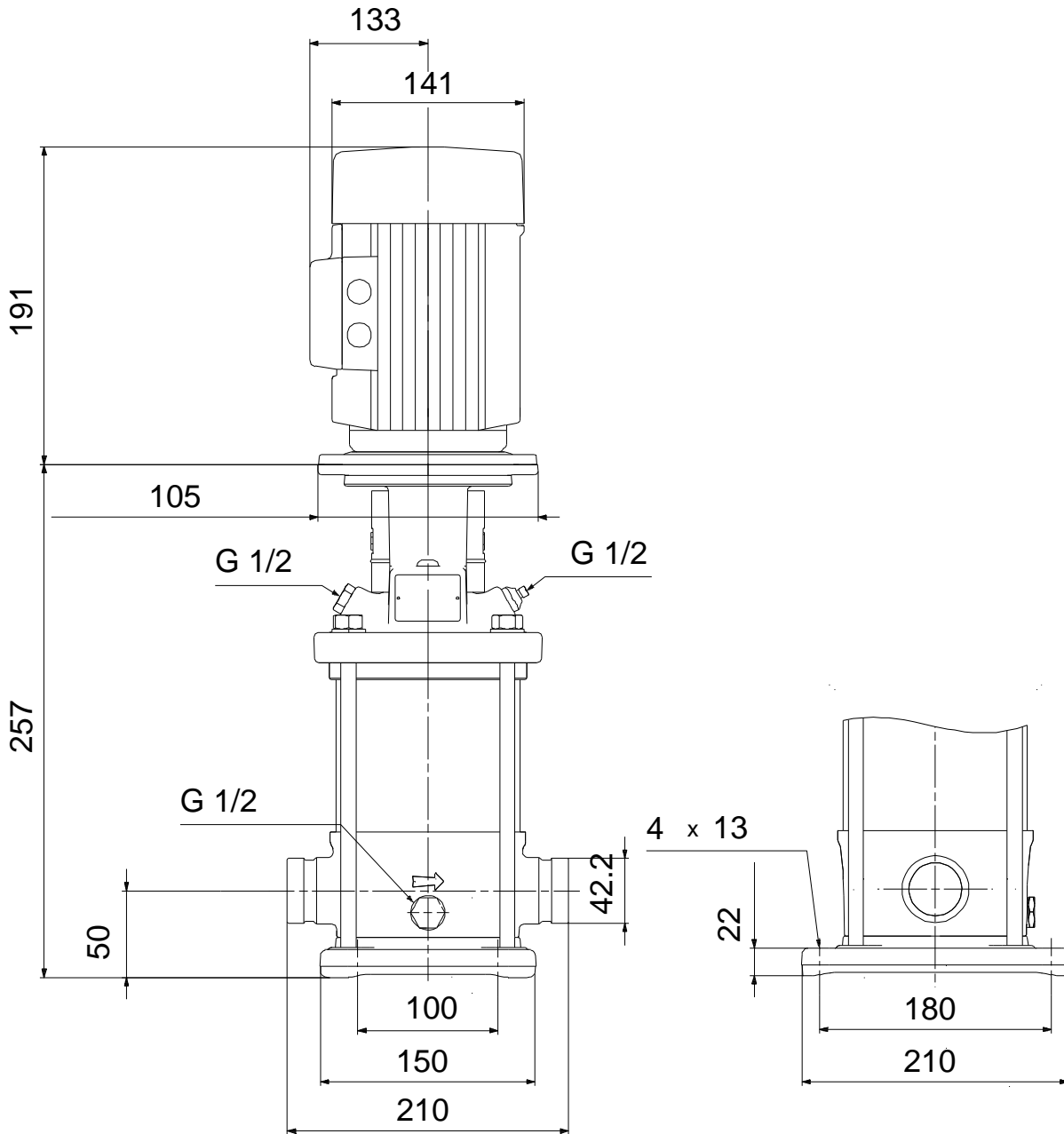

Note! All units are in [mm] unless others are stated.
Disclaimer: This simplified dimensional drawing does not show all details.