

Qty.	Description
1	<p data-bbox="199 336 526 369"><b>CRN 3-10 A-FGJ-H-E-HQQE</b></p> <div data-bbox="343 380 438 638" style="text-align: center;">  </div> <p data-bbox="199 660 470 694">Product No.: <a href="#">96531549</a></p> <p data-bbox="199 716 1404 817">Vertical, multistage centrifugal pump with inlet and outlet ports on same the level (inline). Pump materials in contact with the liquid are in high-grade stainless steel. A cartridge shaft seal ensures high reliability, safe handling, and easy access and service. Power transmission is via a rigid split coupling. Pipe connection is via combined DIN-ANSI-JIS flanges.</p> <p data-bbox="199 862 933 896">The pump is fitted with a 3-phase, fan-cooled asynchronous motor.</p> <p data-bbox="199 918 319 952"><b>Controls:</b></p> <p data-bbox="199 952 638 985">Frequency converter:                    NONE</p> <p data-bbox="199 1008 287 1041"><b>Liquid:</b></p> <p data-bbox="199 1041 638 1075">Pumped liquid:                            Water</p> <p data-bbox="199 1075 710 1108">Liquid temperature range:            -20 .. 120 °C</p> <p data-bbox="199 1108 686 1142">Liquid temperature during operation: 20 °C</p> <p data-bbox="199 1142 702 1176">Density:                                      998.2 kg/m<sup>3</sup></p> <p data-bbox="199 1198 327 1232"><b>Technical:</b></p> <p data-bbox="199 1232 821 1265">Pump speed on which pump data are based: 2864 rpm</p> <p data-bbox="199 1265 638 1299">Rated flow:                                  3 m<sup>3</sup>/h</p> <p data-bbox="199 1299 638 1332">Rated head:                                  46.4 m</p> <p data-bbox="199 1332 638 1366">Pump orientation:                        Vertical</p> <p data-bbox="199 1366 638 1400">Shaft seal arrangement:                Single</p> <p data-bbox="199 1400 638 1433">Code for shaft seal:                      HQQE</p> <p data-bbox="199 1433 726 1467">Approvals on nameplate:               CE, EAC, ACS</p> <p data-bbox="199 1467 766 1500">Curve tolerance:                          ISO9906:2012 3B</p> <p data-bbox="199 1523 327 1556"><b>Materials:</b></p> <p data-bbox="199 1556 726 1590">Base:    Stainless steel</p> <p data-bbox="566 1590 686 1624">EN 1.4408</p> <p data-bbox="566 1624 662 1657">AISI 316</p> <p data-bbox="199 1657 726 1691">Impeller:                                    Stainless steel</p> <p data-bbox="566 1691 686 1724">EN 1.4401</p> <p data-bbox="566 1724 662 1758">AISI 316</p> <p data-bbox="199 1758 606 1792">Bearing:                                      SIC</p> <p data-bbox="199 1814 343 1848"><b>Installation:</b></p> <p data-bbox="199 1848 630 1881">Maximum ambient temperature: 60 °C</p> <p data-bbox="199 1881 638 1915">Maximum operating pressure: 25 bar</p> <p data-bbox="199 1915 742 1948">Max pressure at stated temp: 25 bar / 120 °C</p> <p data-bbox="566 1948 734 1982">25 bar / -20 °C</p> <p data-bbox="199 1982 742 2016">Type of connection:                      DIN / ANSI / JIS</p> <p data-bbox="199 2016 678 2049">Size of inlet connection:                DN 25/32</p> <p data-bbox="566 2049 678 2083">1 1/4 inch</p> <p data-bbox="199 2083 678 2116">Size of outlet connection:               DN 25/32</p> <p data-bbox="566 2116 678 2150">1 1/4 inch</p> <p data-bbox="199 2150 686 2184">Pressure rating for pipe connection: PN 25</p> <p data-bbox="199 2184 638 2217">Flange rating inlet:                       300 lb</p>

Qty.	Description
	<p>Flange size for motor: FT100</p> <p><b>Electrical data:</b></p> <p>Motor standard: IEC</p> <p>Motor type: 80A</p> <p>IE Efficiency class: IE3</p> <p>Rated power - P2: 0.75 kW</p> <p>Power (P2) required by pump: 0.75 kW</p> <p>Mains frequency: 50 Hz</p> <p>Rated voltage: 3 x 220-240D/380-415Y V</p> <p>Rated current: 3.30/1.90 A</p> <p>Starting current: 580-620 %</p> <p>Cos phi - power factor: 0.81-0.71</p> <p>Rated speed: 2840-2870 rpm</p> <p>Efficiency: IE3 80,7%</p> <p>Motor efficiency at full load: 80.7 %</p> <p>Motor efficiency at 3/4 load: 82.7 %</p> <p>Motor efficiency at 1/2 load: 81.7 %</p> <p>Number of poles: 2</p> <p>Enclosure class (IEC 34-5): 55 Dust/Jetting</p> <p>Insulation class (IEC 85): F</p> <p><b>Others:</b></p> <p>Minimum efficiency index, MEI <math>\hat{\alpha}\%</math>: 0.70</p> <p>Net weight: 24.8 kg</p> <p>Gross weight: 27.7 kg</p> <p>Shipping volume: 0.074 m<sup>3</sup></p> <p>Country of origin: GB</p> <p>Custom tariff no.: 84137075</p>

## 96531549 CRN 3-10 A-FGJ-H-E-HQQE 50 Hz

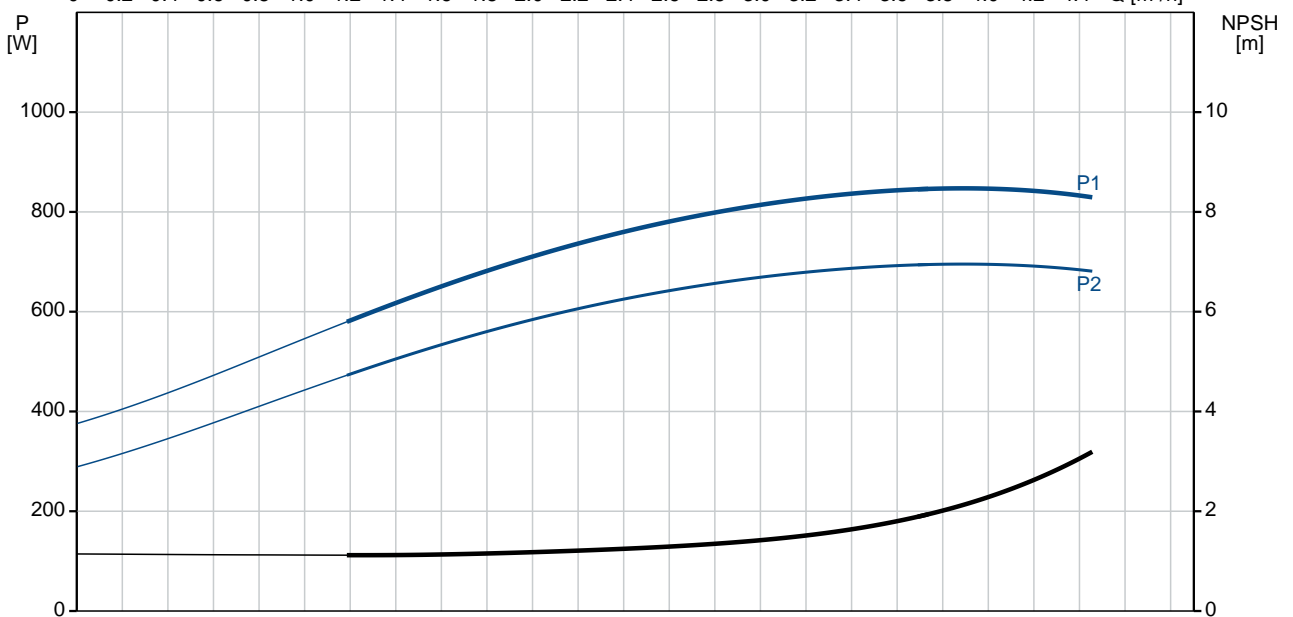
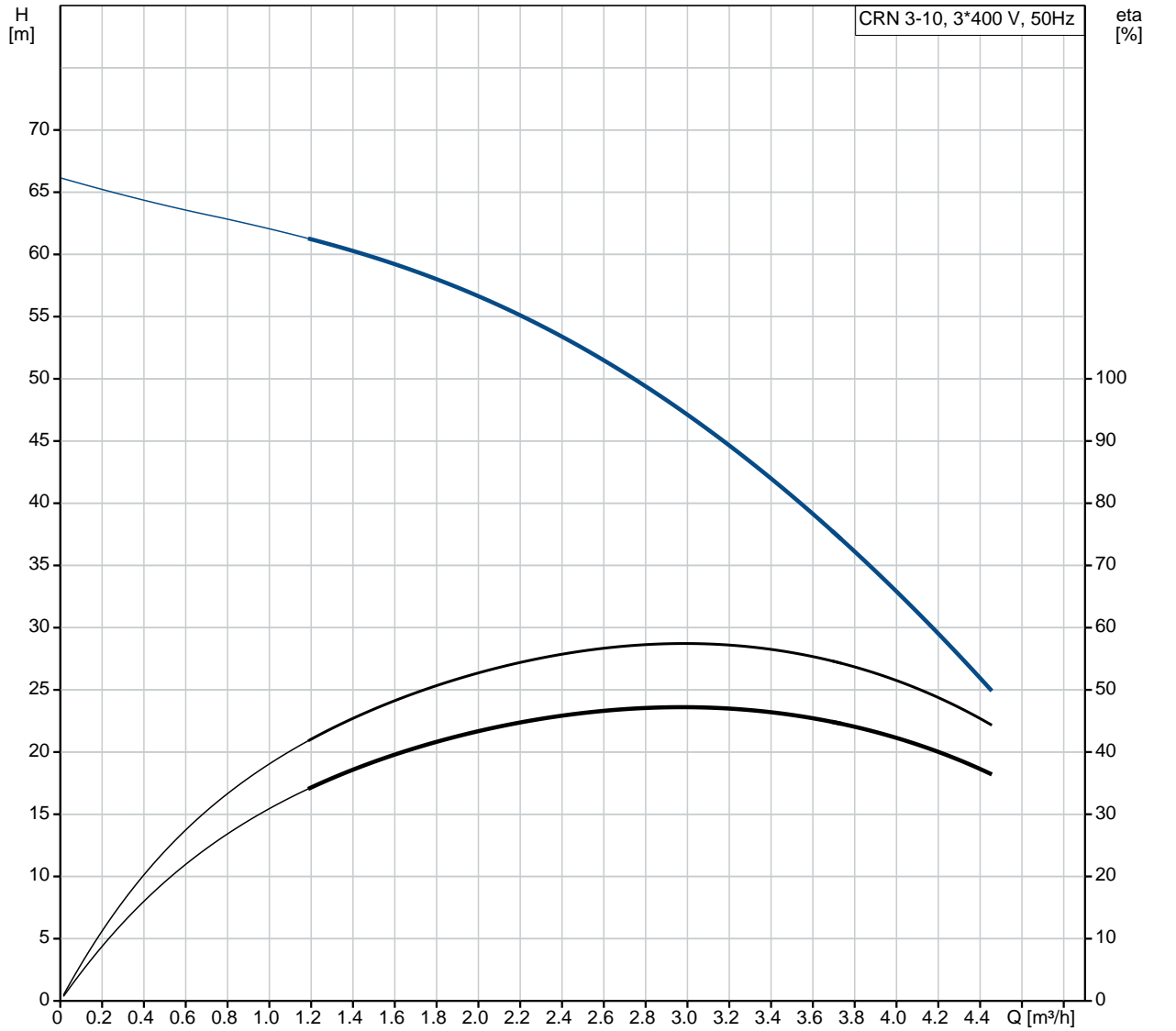

Description	Value
<b>General information:</b>	
Product name:	CRN 3-10 A-FGJ-H-E-HQQE
Product No:	96531549
EAN number:	5700397295694
Price:	1.209,00 GBP
<b>Technical:</b>	
Pump speed on which pump data are based:	2864 rpm
Rated flow:	3 m <sup>3</sup> /h
Rated head:	46.4 m
Head max:	65.6 m
Stages:	10
Impellers:	10
Number of reduced-diameter impellers:	0
Low NPSH:	N
Pump orientation:	Vertical
Shaft seal arrangement:	Single
Code for shaft seal:	HQQE
Approvals on nameplate:	CE, EAC, ACS
Curve tolerance:	ISO9906:2012 3B
Pump version:	A
Model:	A
<b>Materials:</b>	
Base:	Stainless steel EN 1.4408 AISI 316
Impeller:	Stainless steel EN 1.4401 AISI 316
Material code:	H
Code for rubber:	E
Bearing:	SIC
<b>Installation:</b>	
Maximum ambient temperature:	60 °C
Maximum operating pressure:	25 bar
Max pressure at stated temp:	25 bar / 120 °C 25 bar / -20 °C
Type of connection:	DIN / ANSI / JIS
Size of inlet connection:	DN 25/32 1 1/4 inch
Size of outlet connection:	DN 25/32 1 1/4 inch
Pressure rating for pipe connection:	PN 25
Flange rating inlet:	300 lb
Flange size for motor:	FT100
Connect code:	FGJ
<b>Liquid:</b>	
Pumped liquid:	Water
Liquid temperature range:	-20 .. 120 °C
Liquid temperature during operation:	20 °C
Density:	998.2 kg/m <sup>3</sup>
<b>Electrical data:</b>	
Motor standard:	IEC
Motor type:	80A
IE Efficiency class:	IE3
Rated power - P2:	0.75 kW
Power (P2) required by pump:	0.75 kW
Mains frequency:	50 Hz

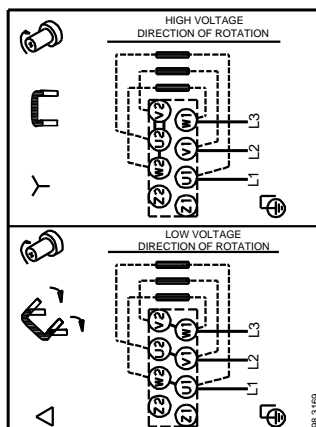
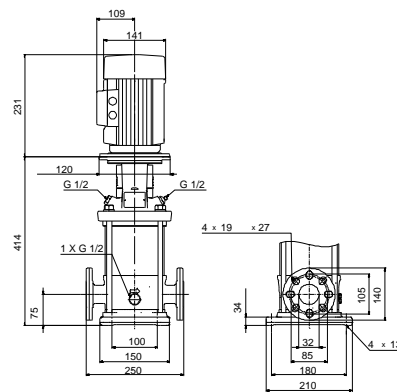
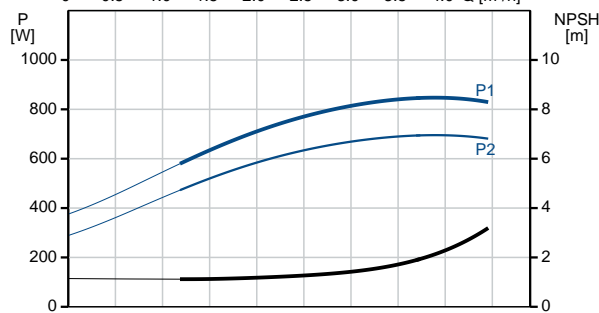
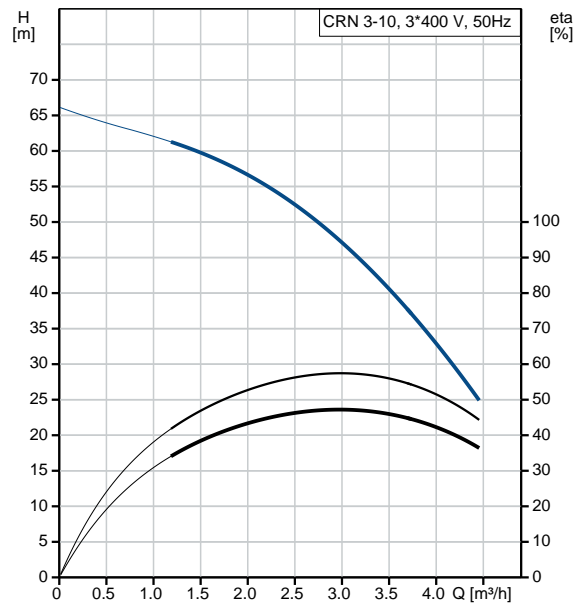



Company name:

Created by:

Phone:

Date:

07/03/2019

Description	Value
Rated voltage:	3 x 220-240D/380-415Y V
Rated current:	3.30/1.90 A
Starting current:	580-620 %
Cos phi - power factor:	0.81-0.71
Rated speed:	2840-2870 rpm
Efficiency:	IE3 80,7%
Motor efficiency at full load:	80.7 %
Motor efficiency at 3/4 load:	82.7 %
Motor efficiency at 1/2 load:	81.7 %
Number of poles:	2
Enclosure class (IEC 34-5):	55 Dust/Jetting
Insulation class (IEC 85):	F
Motor protec:	NONE
Motor No:	85U05104
<b>Controls:</b>	
Frequency converter:	NONE
<b>Others:</b>	
Minimum efficiency index, MEI $\hat{\alpha}\%$ :	0.70
Net weight:	24.8 kg
Gross weight:	27.7 kg
Shipping volume:	0.074 m <sup>3</sup>
Sales region:	Great Britain
Country of origin:	GB
Custom tariff no.:	84137075

## 96531549 CRN 3-10 A-FGJ-H-E-HQQE 50 Hz

