

Qty.	Description
1	<p data-bbox="199 338 544 367">CRN 1S-10 A-FGJ-H-E-HQQE</p>  <p data-bbox="199 660 469 689">Product No.: 96531238</p> <p data-bbox="199 719 1382 797">Vertical, multistage centrifugal pump with inlet and outlet ports on same the level (inline). Pump materials in contact with the liquid are in high-grade stainless steel. Power transmission is via a rigid split coupling. Pipe connection is via combined DIN-ANSI-JIS flanges.</p> <p data-bbox="199 835 935 864">The pump is fitted with a 3-phase, fan-cooled asynchronous motor.</p> <p data-bbox="199 896 316 925">Controls:</p> <p data-bbox="199 925 638 954">Frequency converter: NONE</p> <p data-bbox="199 985 288 1014">Liquid:</p> <p data-bbox="199 1014 707 1133">Pumped liquid: Water Liquid temperature range: -20 .. 120 °C Liquid temperature during operation: 20 °C Density: 998.2 kg/m³</p> <p data-bbox="199 1164 328 1193">Technical:</p> <p data-bbox="199 1193 821 1429">Pump speed on which pump data are based: 2873 rpm Rated flow: 0.9 m³/h Rated head: 39.9 m Pump orientation: Vertical Shaft seal arrangement: Single Code for shaft seal: HQQE Approvals on nameplate: CE, EAC, ACS Curve tolerance: ISO9906:2012 3B</p> <p data-bbox="199 1460 320 1489">Materials:</p> <p data-bbox="199 1489 727 1697">Base: Stainless steel EN 1.4408 AISI 316 Impeller: Stainless steel EN 1.4401 AISI 316 Bearing: SIC</p> <p data-bbox="199 1729 344 1758">Installation:</p> <p data-bbox="199 1758 743 2085">Maximum ambient temperature: 40 °C Maximum operating pressure: 25 bar Max pressure at stated temp: 25 bar / 120 °C 25 bar / -20 °C Type of connection: DIN / ANSI / JIS Size of inlet connection: DN 25/32 1 1/4 inch Size of outlet connection: DN 25/32 1 1/4 inch Pressure rating for pipe connection: PN 25 Flange rating inlet: 300 lb</p>

Qty.	Description
	<p>Flange size for motor: FT85</p> <p>Electrical data:</p> <p>Motor standard: IEC</p> <p>Motor type: 71A</p> <p>IE Efficiency class: IE3</p> <p>Rated power - P2: 0.37 kW</p> <p>Power (P2) required by pump: 0.37 kW</p> <p>Mains frequency: 50 Hz</p> <p>Rated voltage: 3 x 220-240D/380-415Y V</p> <p>Rated current: 1.74/1.00 A</p> <p>Starting current: 490-530 %</p> <p>Cos phi - power factor: 0.80-0.70</p> <p>Rated speed: 2850-2880 rpm</p> <p>Efficiency: IE3 73,8%</p> <p>Motor efficiency at full load: 73.8 %</p> <p>Motor efficiency at 3/4 load: 79.0 %</p> <p>Motor efficiency at 1/2 load: 75.5 %</p> <p>Number of poles: 2</p> <p>Enclosure class (IEC 34-5): 55 Dust/Jetting</p> <p>Insulation class (IEC 85): F</p> <p>Others:</p> <p>Minimum efficiency index, MEI $\hat{\alpha}\%$: 0.54</p> <p>Net weight: 21.8 kg</p> <p>Gross weight: 24.5 kg</p> <p>Shipping volume: 0.063 m³</p> <p>Country of origin: GB</p> <p>Custom tariff no.: 84137075</p>

96531238 CRN 1S-10 A-FGJ-H-E-HQQE 50 Hz

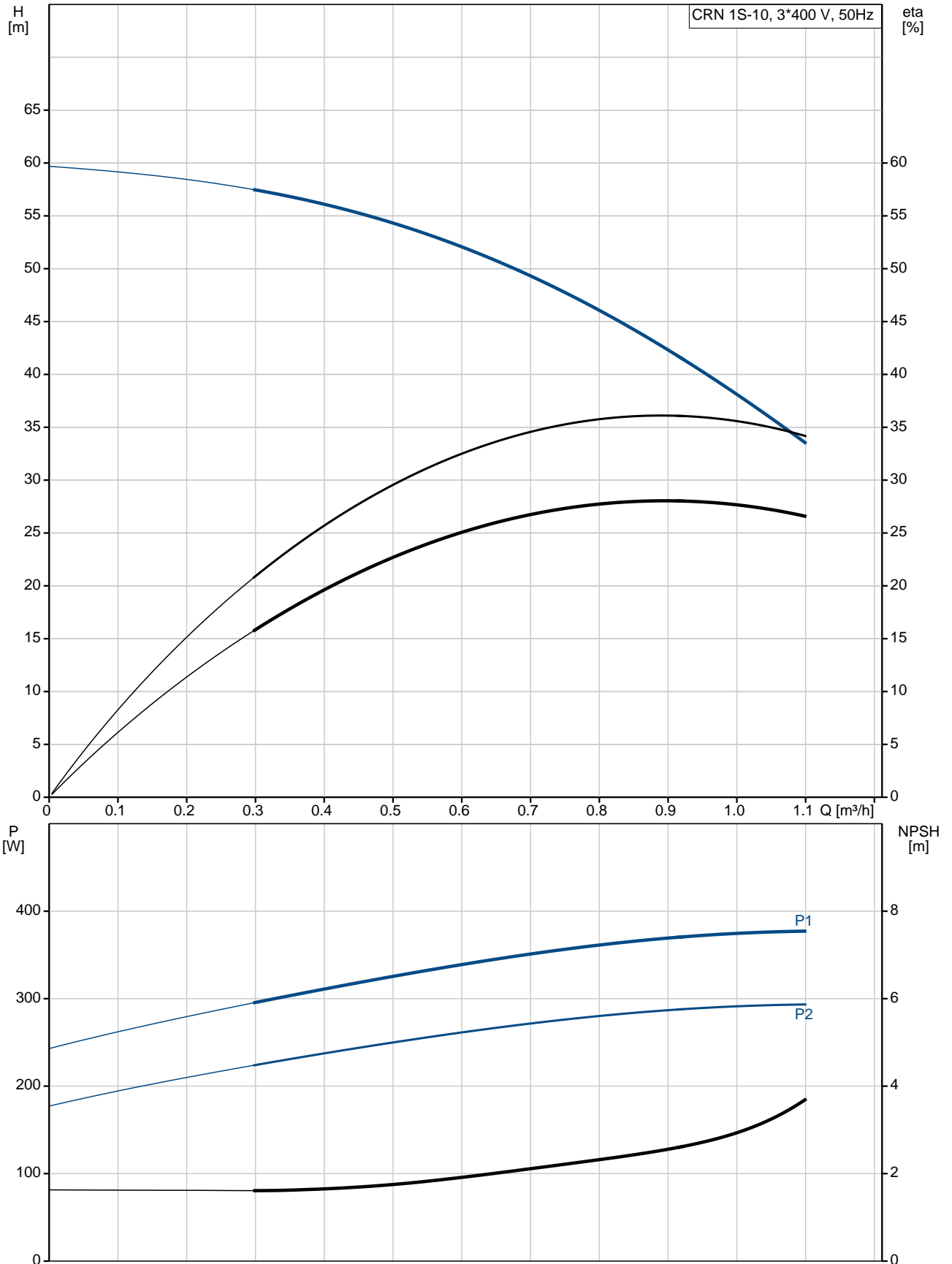

Description	Value
General information:	
Product name:	CRN 1S-10 A-FGJ-H-E-HQQE
Product No:	96531238
EAN number:	5700397252475
Price:	1.119,00 GBP
Technical:	
Pump speed on which pump data are based:	2873 rpm
Rated flow:	0.9 m³/h
Rated head:	39.9 m
Head max:	58.9 m
Stages:	10
Impellers:	10
Number of reduced-diameter impellers:	0
Low NPSH:	N
Pump orientation:	Vertical
Shaft seal arrangement:	Single
Code for shaft seal:	HQQE
Approvals on nameplate:	CE, EAC, ACS
Curve tolerance:	ISO9906:2012 3B
Pump version:	A
Model:	A
Materials:	
Base:	Stainless steel EN 1.4408 AISI 316
Impeller:	Stainless steel EN 1.4401 AISI 316
Material code:	H
Code for rubber:	E
Bearing:	SIC
Installation:	
Maximum ambient temperature:	40 °C
Maximum operating pressure:	25 bar
Max pressure at stated temp:	25 bar / 120 °C 25 bar / -20 °C
Type of connection:	DIN / ANSI / JIS
Size of inlet connection:	DN 25/32 1 1/4 inch
Size of outlet connection:	DN 25/32 1 1/4 inch
Pressure rating for pipe connection:	PN 25
Flange rating inlet:	300 lb
Flange size for motor:	FT85
Connect code:	FGJ
Liquid:	
Pumped liquid:	Water
Liquid temperature range:	-20 .. 120 °C
Liquid temperature during operation:	20 °C
Density:	998.2 kg/m³
Electrical data:	
Motor standard:	IEC
Motor type:	71A
IE Efficiency class:	IE3
Rated power - P2:	0.37 kW
Power (P2) required by pump:	0.37 kW

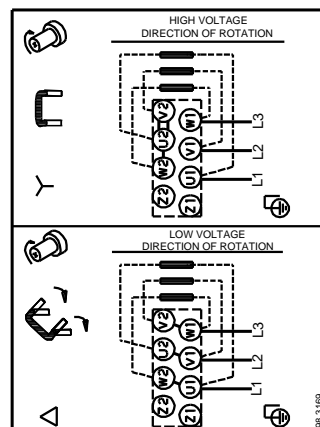
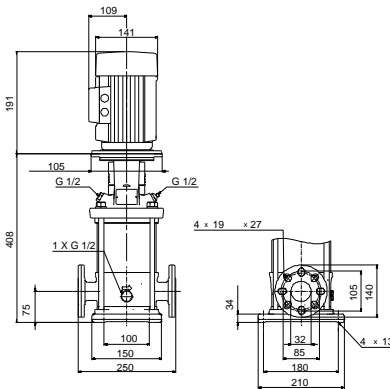
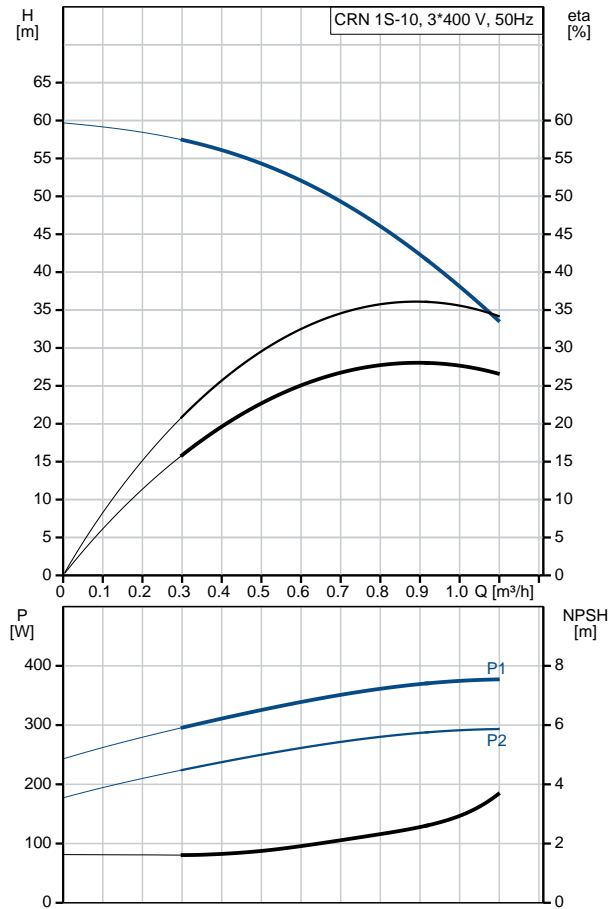



Company name:

Created by:

Phone:

Date: 07/03/2019

Description	Value
Mains frequency:	50 Hz
Rated voltage:	3 x 220-240D/380-415Y V
Rated current:	1.74/1.00 A
Starting current:	490-530 %
Cos phi - power factor:	0.80-0.70
Rated speed:	2850-2880 rpm
Efficiency:	IE3 73,8%
Motor efficiency at full load:	73.8 %
Motor efficiency at 3/4 load:	79.0 %
Motor efficiency at 1/2 load:	75.5 %
Number of poles:	2
Enclosure class (IEC 34-5):	55 Dust/Jetting
Insulation class (IEC 85):	F
Motor protec:	NONE
Motor No:	85805102
Controls:	
Frequency converter:	NONE
Others:	
Minimum efficiency index, MEI $\hat{a}\%$ ¥:	0.54
Net weight:	21.8 kg
Gross weight:	24.5 kg
Shipping volume:	0.063 m ³
Sales region:	Great Britain
Country of origin:	GB
Custom tariff no.:	84137075

96531238 CRN 1S-10 A-FGJ-H-E-HQQE 50 Hz

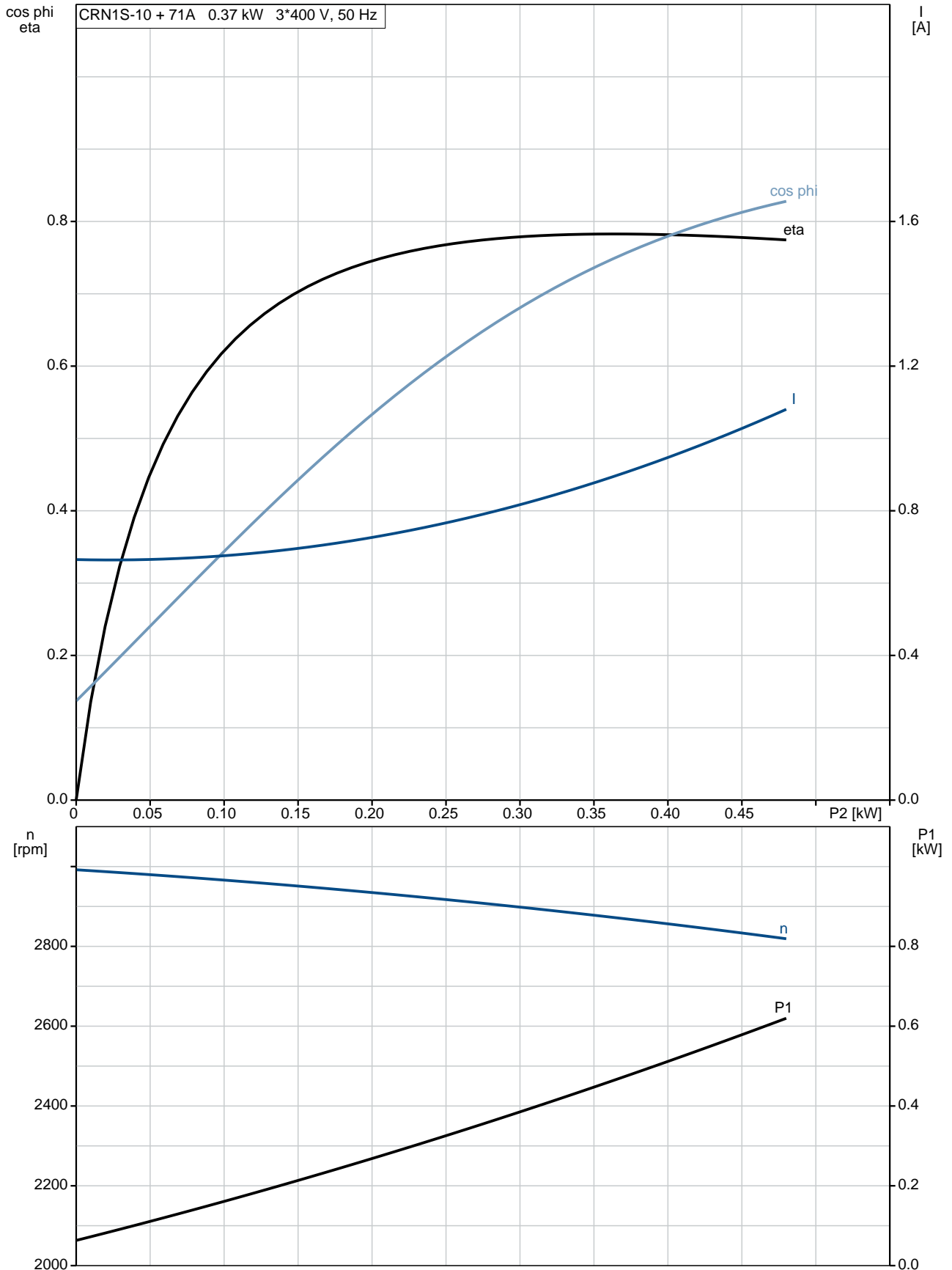

96531238 CRN 1S-10 A-FGJ-H-E-HQQE 50 Hz

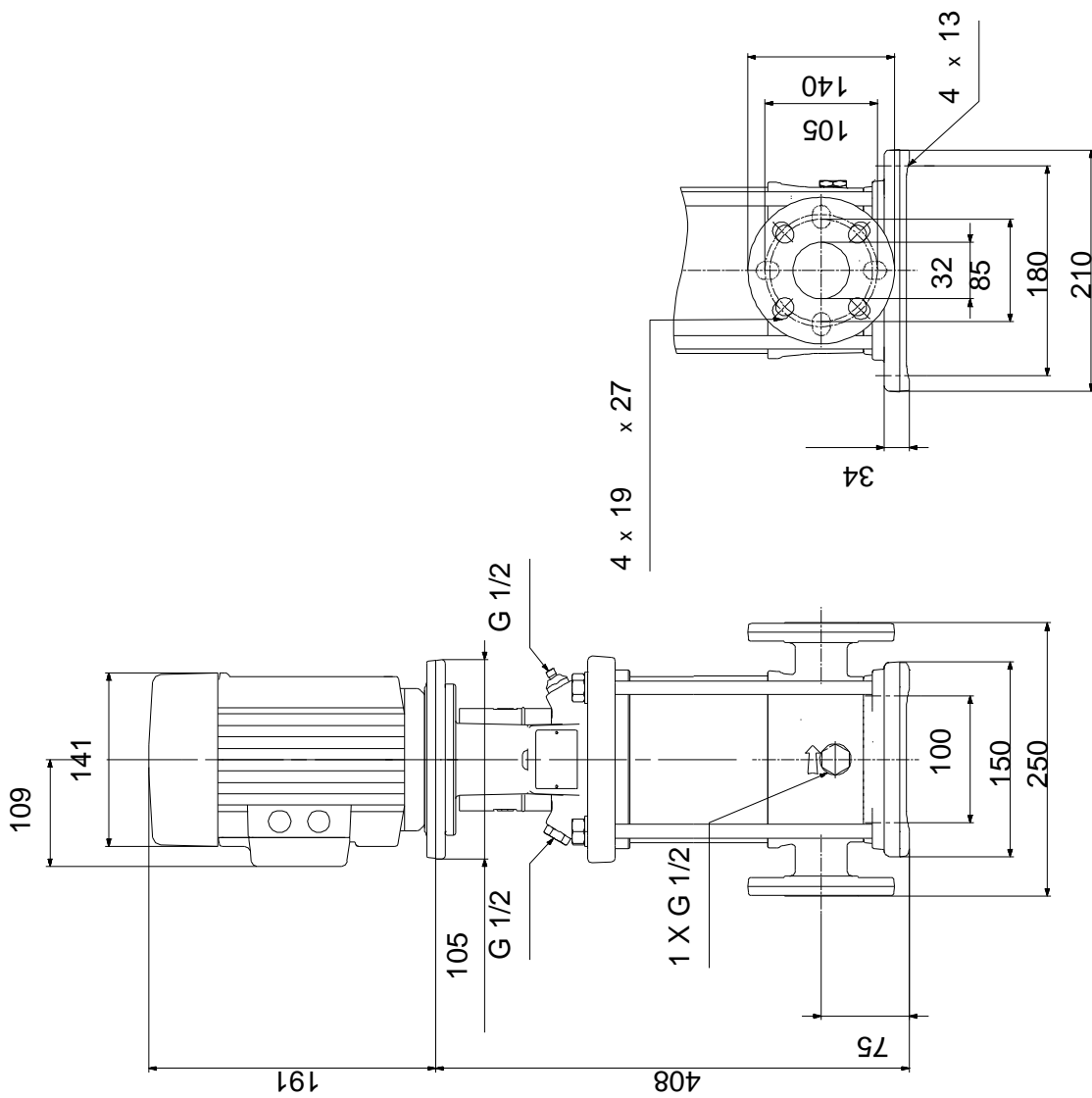

Note! All units are in [mm] unless others are stated.
Disclaimer: This simplified dimensional drawing does not show all details.