

Position	Qty.	Description
	1	<p><b>GT-H-60 PN10 G1 V</b></p>  <p><b>Note! Product picture may differ from actual product</b></p> <p>Product No.: <a href="#">96528341</a></p> <p>Grundfos GT-H-60 PN10 G1 V is a Diaphragm pressure tank, with a capacity of 60.0 l and Vertical installation. The tanks are approved for drinking water. The GT-H-60 PN10 G1 V is designed for a maximum operation pressure of 10 bar and a maximum liquid temperature of 90 °C.</p> <p>The tank is a steel pressure tank with a non-toxic butyl rubber diaphragm with a precision-moulded polypropylene liner for superior air and water separation.</p> <p>A pressure tank ensures controlled pressure in the water supply and thereby limits the switching frequency of the pump in case of low water consumption or leakage loss. The result is increased comfort in your installation by limiting the start/stop frequency of your pump, and it increases system comfort by compensating for pressure drops when a tap is opened, while reducing problems with water hammer in the pipework.</p> <p><b>Liquid:</b> Maximum liquid temperature: 90 °C</p> <p><b>Technical:</b> Membrane type: Diaphragm</p> <p><b>Materials:</b> Material: Carbon steel / Polypropylene</p> <p><b>Installation:</b> Maximum operating pressure: 10 bar Size: 60.0</p> <p><b>Others:</b> Net weight: 10.9 kg Gross weight: 12.4 kg Applicat. typ: Standard Danish VVS No.: 398254760</p>



Company name:

Created by:

Phone:

Date:

01/11/2018

Description	Value
<b>General information:</b>	
Product name:	GT-H-60 PN10 G1 V
Product No:	<a href="#">96528341</a>
EAN number:	5700397133422
<b>Technical:</b>	
Membrane type:	Diaphragm
<b>Materials:</b>	
Material:	Carbon steel / Polypropylene
<b>Installation:</b>	
Maximum operating pressure:	10 bar
Pre-pressure:	1.9 bar
Installation:	Vertical
Size:	60.0
<b>Liquid:</b>	
Maximum liquid temperature:	90 °C
<b>Others:</b>	
Net weight:	10.9 kg
Gross weight:	12.4 kg
Applicat. typ:	Standard
Danish VVS No.:	398254760

**96528341 GT-H-60 PN10 G1 V 50 Hz**

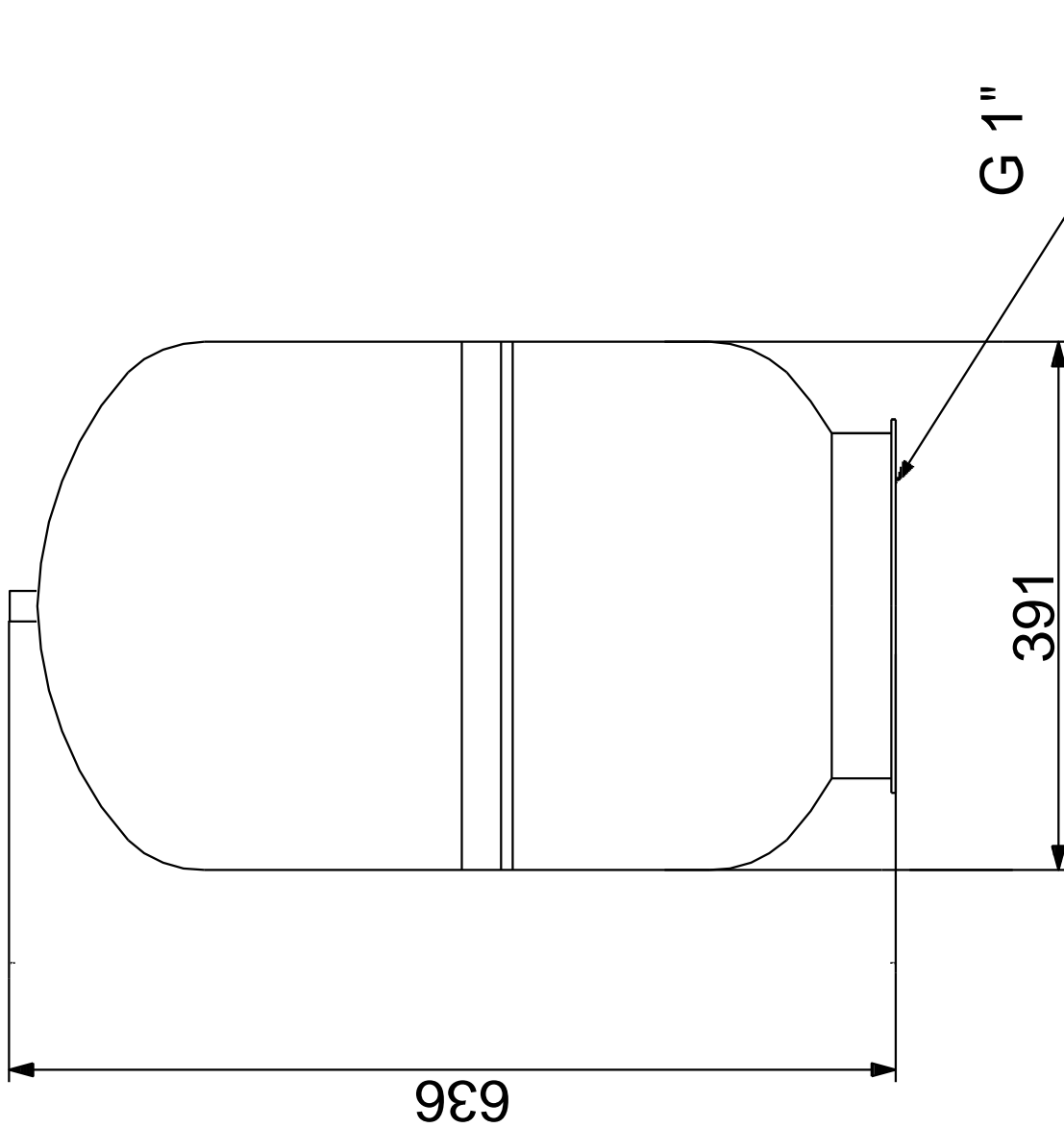

Note! All units are in [mm] unless others are stated.  
Disclaimer: This simplified dimensional drawing does not show all details.