

Position	Qty.	Description
	1	<p><b>CRI 1-3 A-CA-I-V-HQQV</b></p>  <p>Product No.: <a href="#">96516339</a></p> <p>Vertical, multistage centrifugal pump with suction and discharge ports on same the level (in-line) enabling installation in a horizontal one-pipe system. Pump materials in contact with the liquid are in stainless steel. A cartridge shaft seal ensures high reliability, safe handling and easy service and access. Power transmission is via a rigid split coupling. Pipework connection is via FlexiClamps.</p> <p>The pump is fitted with a 3-phase, fan-cooled asynchronous motor.</p> <p><b>Liquid:</b>  Pumped liquid: Water  Liquid temperature range: -20 .. 90 °C  Liquid temperature during operation: 20 °C  Density: 998.2 kg/m<sup>3</sup></p> <p><b>Technical:</b>  Rated flow: 1.8 m<sup>3</sup>/h  Rated head: 15.6 m  Pump orientation: Vertical  Shaft seal arrangement: Single  Code for shaft seal: HQQV  Approvals on nameplate: CE, EAC  Curve tolerance: ISO9906:2012 3B</p> <p><b>Materials:</b>  Base: Stainless steel  EN 1.4408  AISI 316  Impeller: Stainless steel  EN 1.4301  AISI 304  Bearing: SIC</p> <p><b>Installation:</b>  Maximum ambient temperature: 40 °C  Maximum operating pressure: 25 bar  Max pressure at stated temp: 25 bar / 90 °C  25 bar / -20 °C  Type of connection: FlexiClamp  Size of inlet connection: DN 32  1 1/4 inch  Size of outlet connection: DN 32  1 1/4 inch  Pressure rating for pipe connection: PN 25  Flange size for motor: FT85</p> <p><b>Electrical data:</b>  Motor standard: IEC</p>

Position	Qty.	Description
		<p>Motor type: 71A</p> <p>IE Efficiency class: IE3</p> <p>Rated power - P2: 0.37 kW</p> <p>Power (P2) required by pump: 0.37 kW</p> <p>Mains frequency: 50 Hz</p> <p>Rated voltage: 3 x 220-240D/380-415Y V</p> <p>Rated current: 1.74/1.00 A</p> <p>Starting current: 490-530 %</p> <p>Cos phi - power factor: 0.80-0.70</p> <p>Rated speed: 2850-2880 rpm</p> <p>Efficiency: IE3 73,8%</p> <p>Motor efficiency at full load: 73.8 %</p> <p>Motor efficiency at 3/4 load: 79.0 %</p> <p>Motor efficiency at 1/2 load: 75.5 %</p> <p>Number of poles: 2</p> <p>Enclosure class (IEC 34-5): 55 Dust/Jetting</p> <p>Insulation class (IEC 85): F</p> <p><b>Controls:</b></p> <p>Frequency converter: NONE</p> <p><b>Others:</b></p> <p>Minimum efficiency index, MEI : 0.7</p> <p>Net weight: 16.7 kg</p> <p>Gross weight: 19.3 kg</p> <p>Shipping volume: 0.054 m<sup>3</sup></p> <p>Country of origin: GB</p> <p>Custom tariff no.: 84137075</p>

## 96516339 CRI 1-3 A-CA-I-V-HQQV 50 Hz

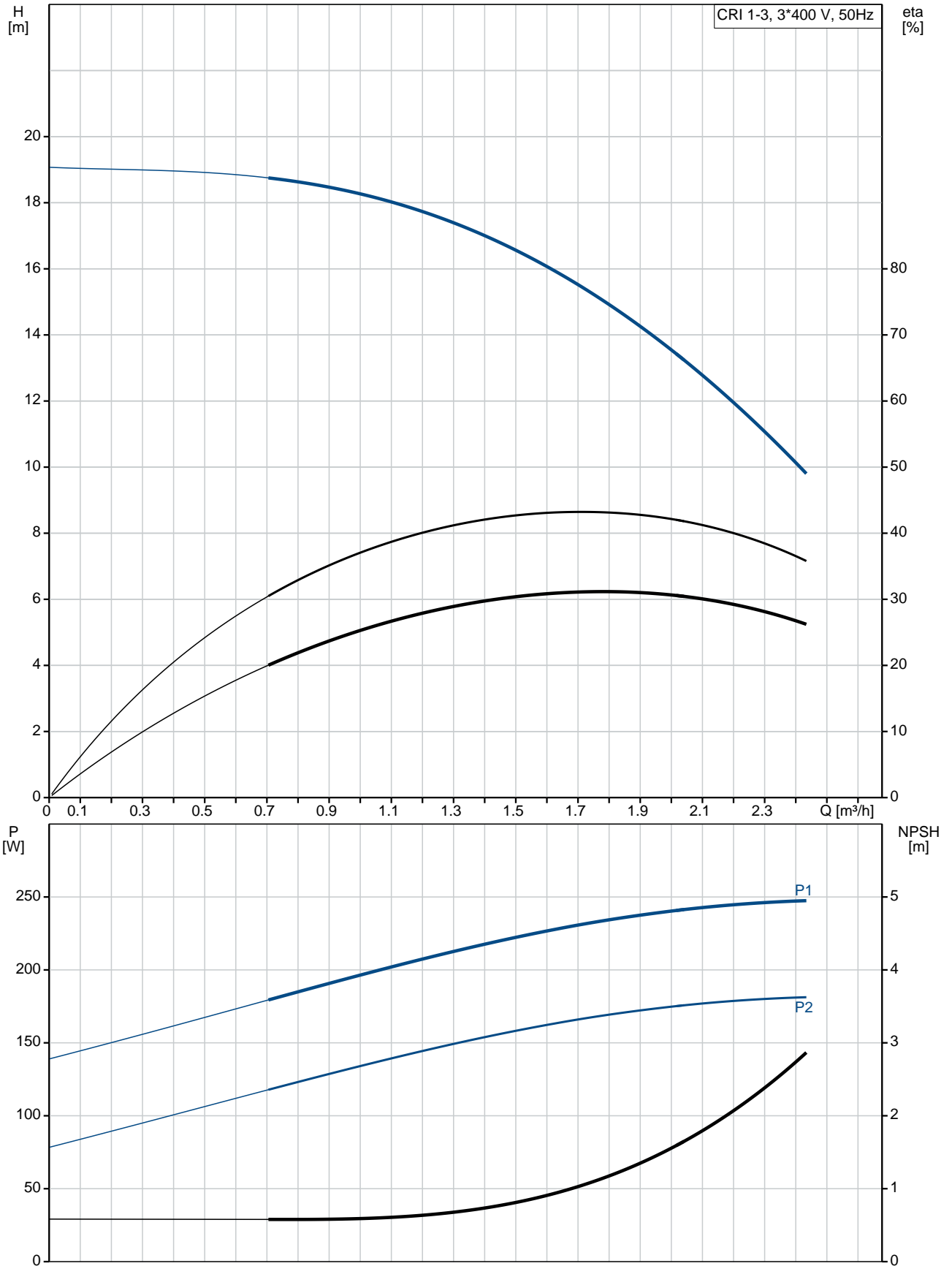

Description	Value
<b>General information:</b>	
Product name:	CRI 1-3 A-CA-I-V-HQQV
Product No:	96516339
EAN number:	5700396741239
Price:	690,00 GBP
<b>Technical:</b>	
Rated flow:	1.8 m <sup>3</sup> /h
Rated head:	15.6 m
Stages:	3
Impellers:	3
Low NPSH:	N
Pump orientation:	Vertical
Shaft seal arrangement:	Single
Code for shaft seal:	HQQV
Approvals on nameplate:	CE, EAC
Curve tolerance:	ISO9906:2012 3B
Pump version:	A
Model:	A
<b>Materials:</b>	
Base:	Stainless steel
	EN 1.4408
	AISI 316
Impeller:	Stainless steel
	EN 1.4301
	AISI 304
Material code:	I
Code for rubber:	V
Bearing:	SIC
<b>Installation:</b>	
Maximum ambient temperature:	40 °C
Maximum operating pressure:	25 bar
Max pressure at stated temp:	25 bar / 90 °C
	25 bar / -20 °C
Type of connection:	FlexiClamp
Size of inlet connection:	DN 32
	1 1/4 inch
Size of outlet connection:	DN 32
	1 1/4 inch
Pressure rating for pipe connection:	PN 25
Flange size for motor:	FT85
Connect code:	CA
<b>Liquid:</b>	
Pumped liquid:	Water
Liquid temperature range:	-20 .. 90 °C
Liquid temperature during operation:	20 °C
Density:	998.2 kg/m <sup>3</sup>
<b>Electrical data:</b>	
Motor standard:	IEC
Motor type:	71A
IE Efficiency class:	IE3
Rated power - P2:	0.37 kW
Power (P2) required by pump:	0.37 kW
Mains frequency:	50 Hz
Rated voltage:	3 x 220-240D/380-415Y V
Rated current:	1.74/1.00 A
Starting current:	490-530 %
Cos phi - power factor:	0.80-0.70
Rated speed:	2850-2880 rpm

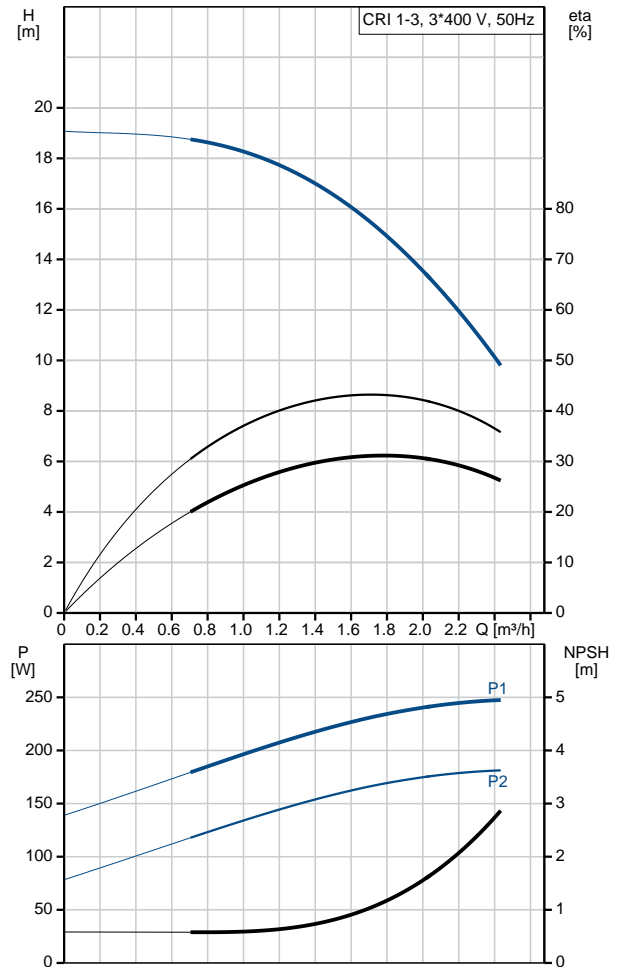



Company name:

Created by:

Phone:

Date:

12/09/2018

Description	Value
Efficiency:	IE3 73,8%
Motor efficiency at full load:	73.8 %
Motor efficiency at 3/4 load:	79.0 %
Motor efficiency at 1/2 load:	75.5 %
Number of poles:	2
Enclosure class (IEC 34-5):	55 Dust/Jetting
Insulation class (IEC 85):	F
Motor protec:	NONE
Motor No:	85805102
<b>Controls:</b>	
Frequency converter:	NONE
<b>Others:</b>	
Minimum efficiency index, MEI :	0.7
Net weight:	16.7 kg
Gross weight:	19.3 kg
Shipping volume:	0.054 m <sup>3</sup>
Country of origin:	GB
Custom tariff no.:	84137075

## 96516339 CRI 1-3 A-CA-I-V-HQQV 50 Hz

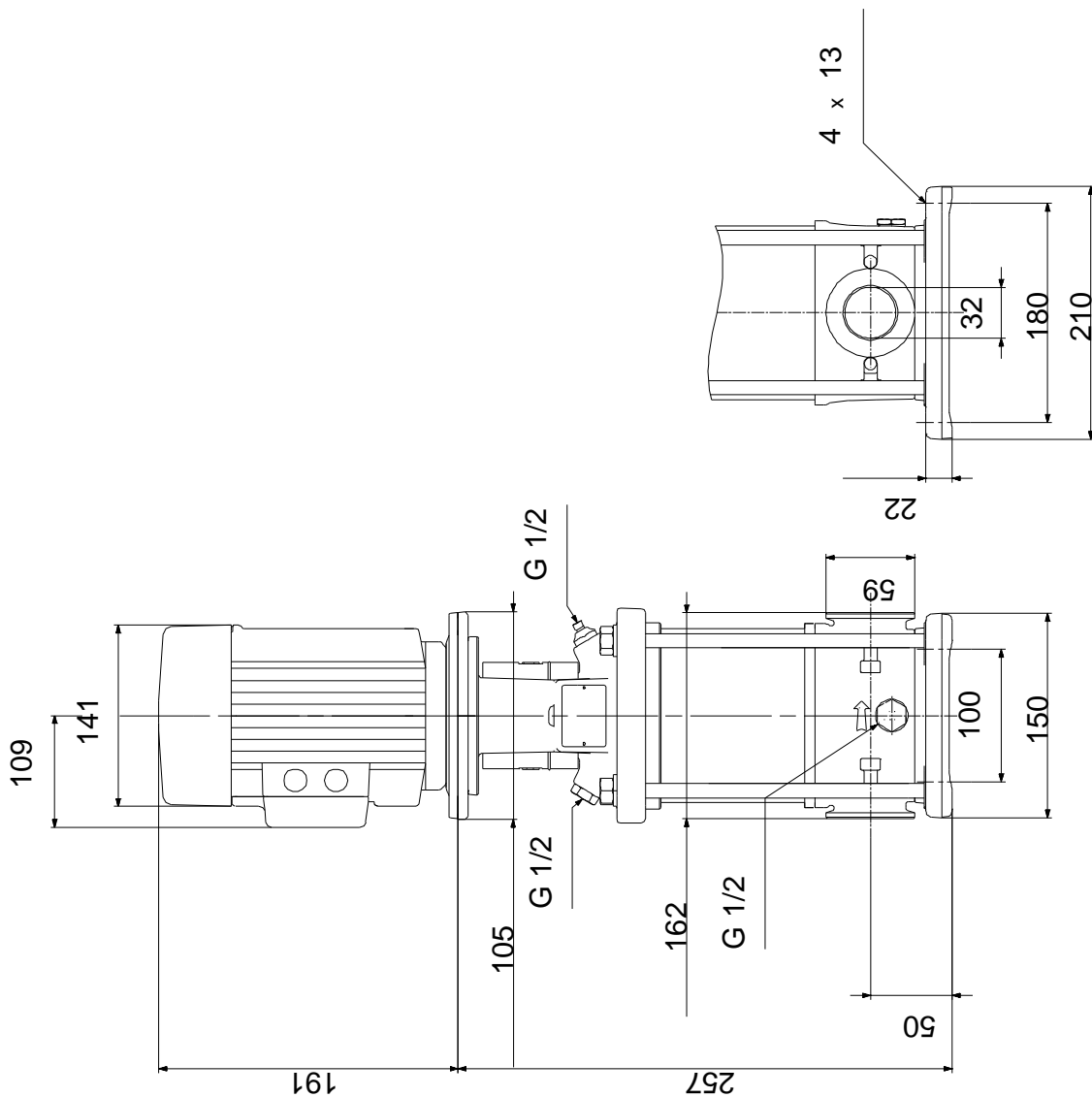

Note! All units are in [mm] unless others are stated.  
Disclaimer: This simplified dimensional drawing does not show all details.

**96516339 CRI 1-3 A-CA-I-V-HQQV 50 Hz**

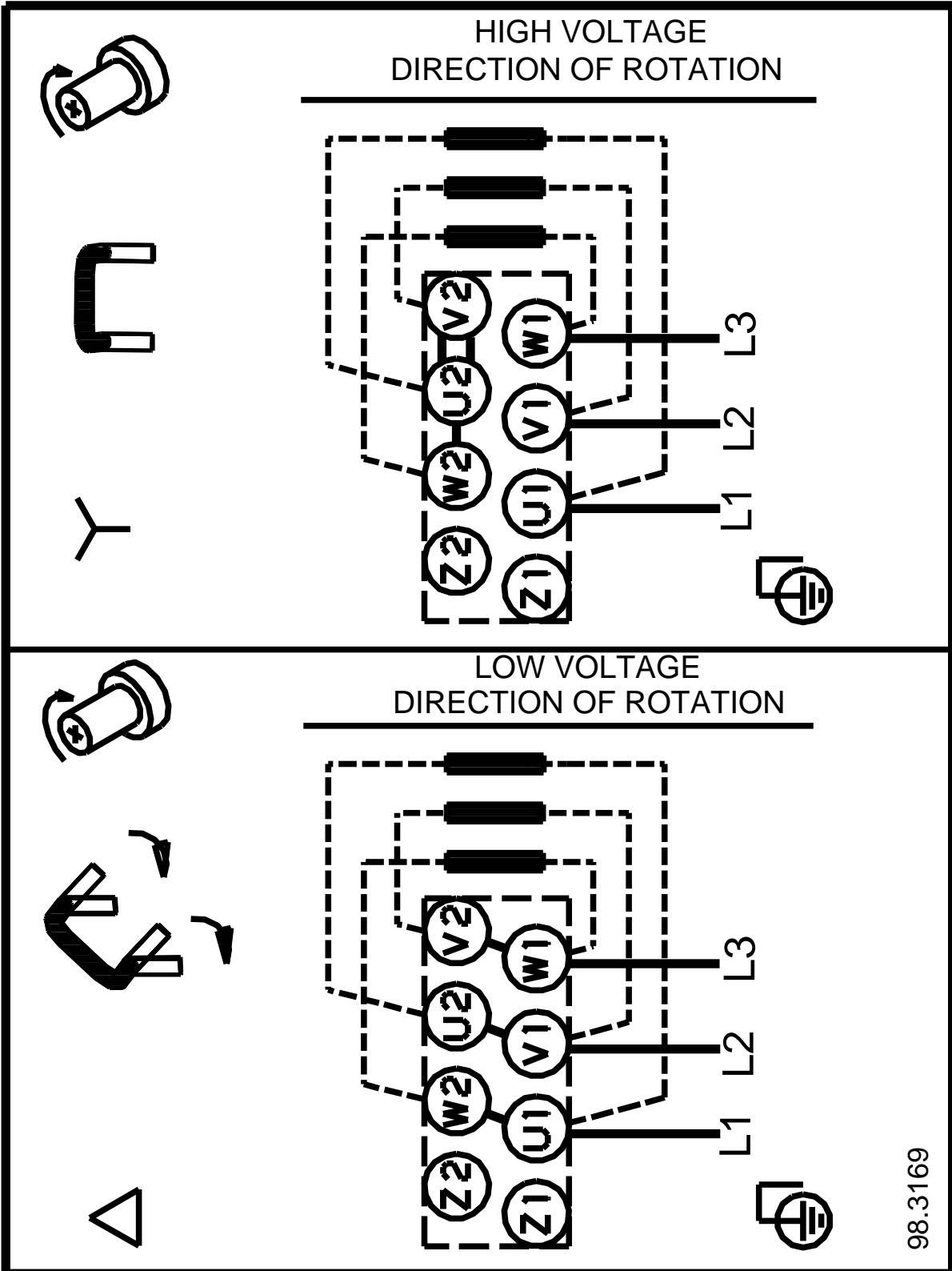

Note! All units are in [mm] unless others are stated.