

Qty. Description

1 CRN 1S-3 A-P-A-E-HQQE



Product No.: [96516036](#)

Vertical, multistage centrifugal pump with inlet and outlet ports on same the level (inline). Pump materials in contact with the liquid are in high-grade stainless steel. Power transmission is via a rigid split coupling. Pipe connection is via PJE (Victaulic®) couplings.

The pump is fitted with a 3-phase, fan-cooled asynchronous motor.

Controls:

Frequency converter: NONE

Liquid:

Pumped liquid: Water
 Liquid temperature range: -20 .. 120 °C
 Liquid temperature during operation: 20 °C
 Density: 998.2 kg/m³

Technical:

Pump speed on which pump data are based: 2873 rpm
 Rated flow: 0.9 m³/h
 Rated head: 12.8 m
 Pump orientation: Vertical
 Shaft seal arrangement: Single
 Code for shaft seal: HQQE
 Approvals on nameplate: CE, EAC, ACS
 Curve tolerance: ISO9906:2012 3B

Materials:

Base: Stainless steel
 EN 1.4408
 AISI 316
 Impeller: Stainless steel
 EN 1.4401
 AISI 316
 Bearing: SIC

Installation:

Maximum ambient temperature: 40 °C
 Maximum operating pressure: 25 bar
 Max pressure at stated temp: 25 bar / 120 °C
 25 bar / -20 °C
 Type of connection: PJE
 Size of inlet connection: DN 32
 1 1/4 inch
 Size of outlet connection: DN 32
 1 1/4 inch
 Pressure rating for pipe connection: PN 50
 Flange size for motor: FT85

Qty.	Description
------	-------------

Electrical data:

Motor standard:	IEC
Motor type:	71A
IE Efficiency class:	IE3
Rated power - P2:	0.37 kW
Power (P2) required by pump:	0.37 kW
Mains frequency:	50 Hz
Rated voltage:	3 x 220-240D/380-415Y V
Rated current:	1.74/1.00 A
Starting current:	490-530 %
Cos phi - power factor:	0.80-0.70
Rated speed:	2850-2880 rpm
Efficiency:	IE3 73,8%
Motor efficiency at full load:	73.8 %
Motor efficiency at 3/4 load:	79.0 %
Motor efficiency at 1/2 load:	75.5 %
Number of poles:	2
Enclosure class (IEC 34-5):	55 Dust/Jetting
Insulation class (IEC 85):	F

Others:

Minimum efficiency index, MEI $\hat{\alpha}\%$:	0.54
Net weight:	16.6 kg
Gross weight:	19.3 kg
Shipping volume:	0.054 m ³
Danish VVS No.:	385910503
Country of origin:	GB
Custom tariff no.:	84137075

96516036 CRN 1S-3 A-P-A-E-HQQE 50 Hz

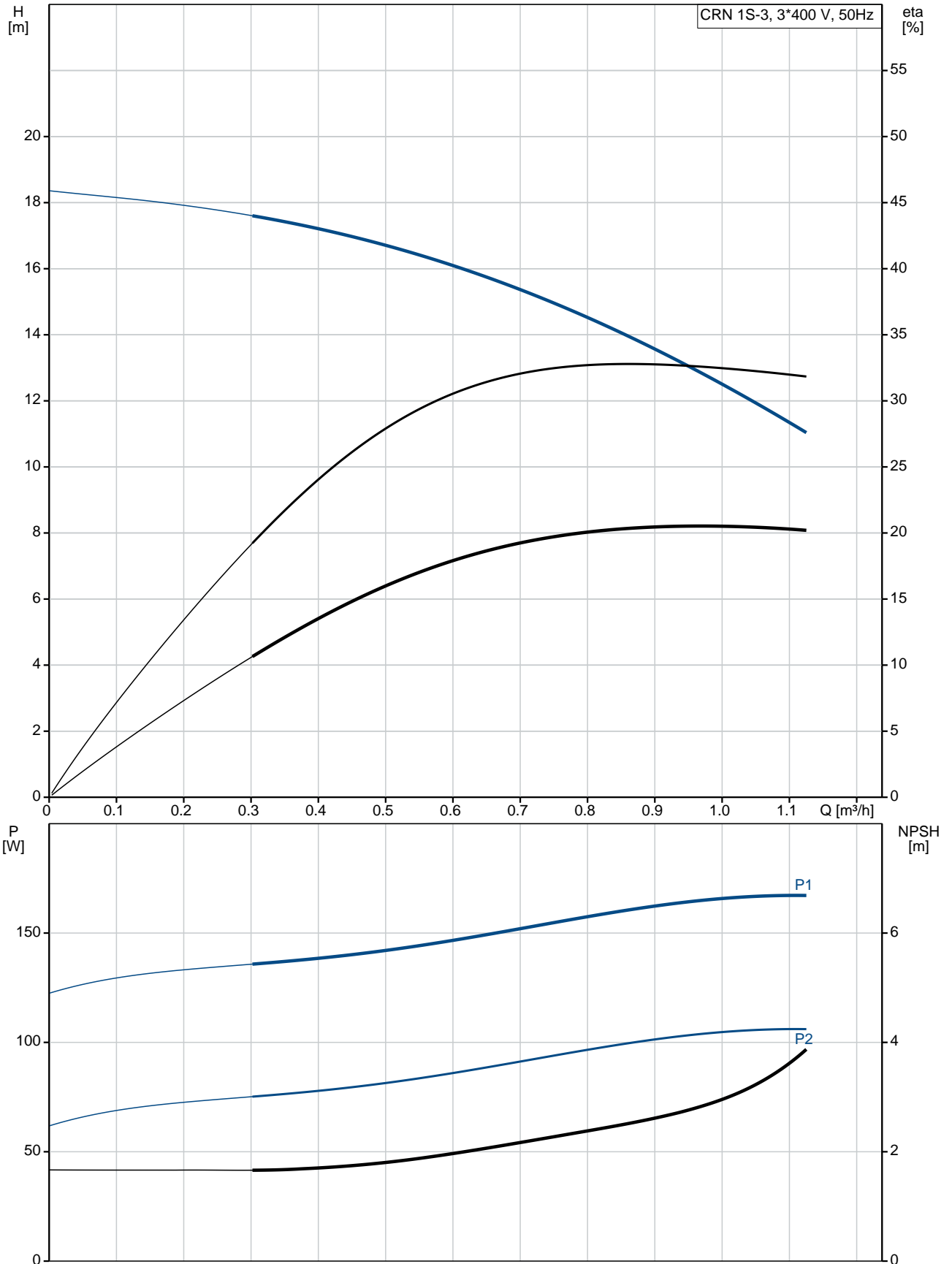

Description	Value
General information:	
Product name:	CRN 1S-3 A-P-A-E-HQQE
Product No:	96516036
EAN number:	5700396735603
Price:	734,00 GBP
Technical:	
Pump speed on which pump data are based:	2873 rpm
Rated flow:	0.9 m³/h
Rated head:	12.8 m
Head max:	18.2 m
Stages:	3
Impellers:	3
Number of reduced-diameter impellers:	0
Low NPSH:	N
Pump orientation:	Vertical
Shaft seal arrangement:	Single
Code for shaft seal:	HQQE
Approvals on nameplate:	CE, EAC, ACS
Curve tolerance:	ISO9906:2012 3B
Pump version:	A
Model:	A
Materials:	
Base:	Stainless steel EN 1.4408 AISI 316
Impeller:	Stainless steel EN 1.4401 AISI 316
Material code:	A
Code for rubber:	E
Bearing:	SIC
Installation:	
Maximum ambient temperature:	40 °C
Maximum operating pressure:	25 bar
Max pressure at stated temp:	25 bar / 120 °C 25 bar / -20 °C
Type of connection:	PJE
Size of inlet connection:	DN 32 1 1/4 inch
Size of outlet connection:	DN 32 1 1/4 inch
Pressure rating for pipe connection:	PN 50
Flange size for motor:	FT85
Connect code:	P
Liquid:	
Pumped liquid:	Water
Liquid temperature range:	-20 .. 120 °C
Liquid temperature during operation:	20 °C
Density:	998.2 kg/m³
Electrical data:	
Motor standard:	IEC
Motor type:	71A
IE Efficiency class:	IE3
Rated power - P2:	0.37 kW
Power (P2) required by pump:	0.37 kW
Mains frequency:	50 Hz

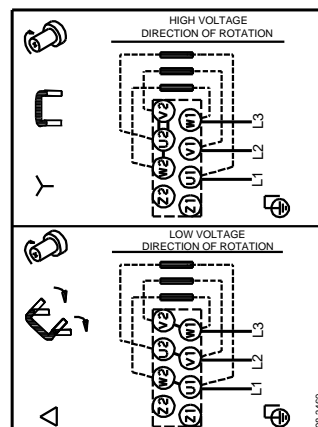
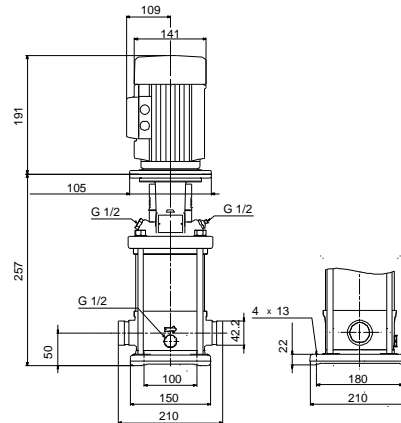
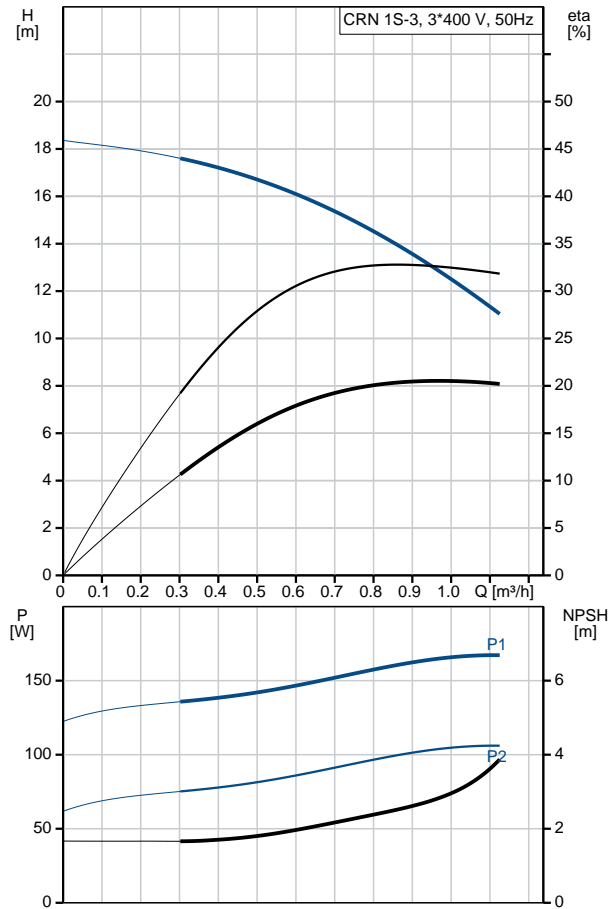



Company name:

Created by:

Phone:

Date:

07/03/2019

Description	Value
Rated voltage:	3 x 220-240D/380-415Y V
Rated current:	1.74/1.00 A
Starting current:	490-530 %
Cos phi - power factor:	0.80-0.70
Rated speed:	2850-2880 rpm
Efficiency:	IE3 73,8%
Motor efficiency at full load:	73.8 %
Motor efficiency at 3/4 load:	79.0 %
Motor efficiency at 1/2 load:	75.5 %
Number of poles:	2
Enclosure class (IEC 34-5):	55 Dust/Jetting
Insulation class (IEC 85):	F
Motor protec:	NONE
Motor No:	85805102
Controls:	
Frequency converter:	NONE
Others:	
Minimum efficiency index, MEI %:	0.54
Net weight:	16.6 kg
Gross weight:	19.3 kg
Shipping volume:	0.054 m ³
Danish VVS No.:	385910503
Country of origin:	GB
Custom tariff no.:	84137075

96516036 CRN 1S-3 A-P-A-E-HQQE 50 Hz

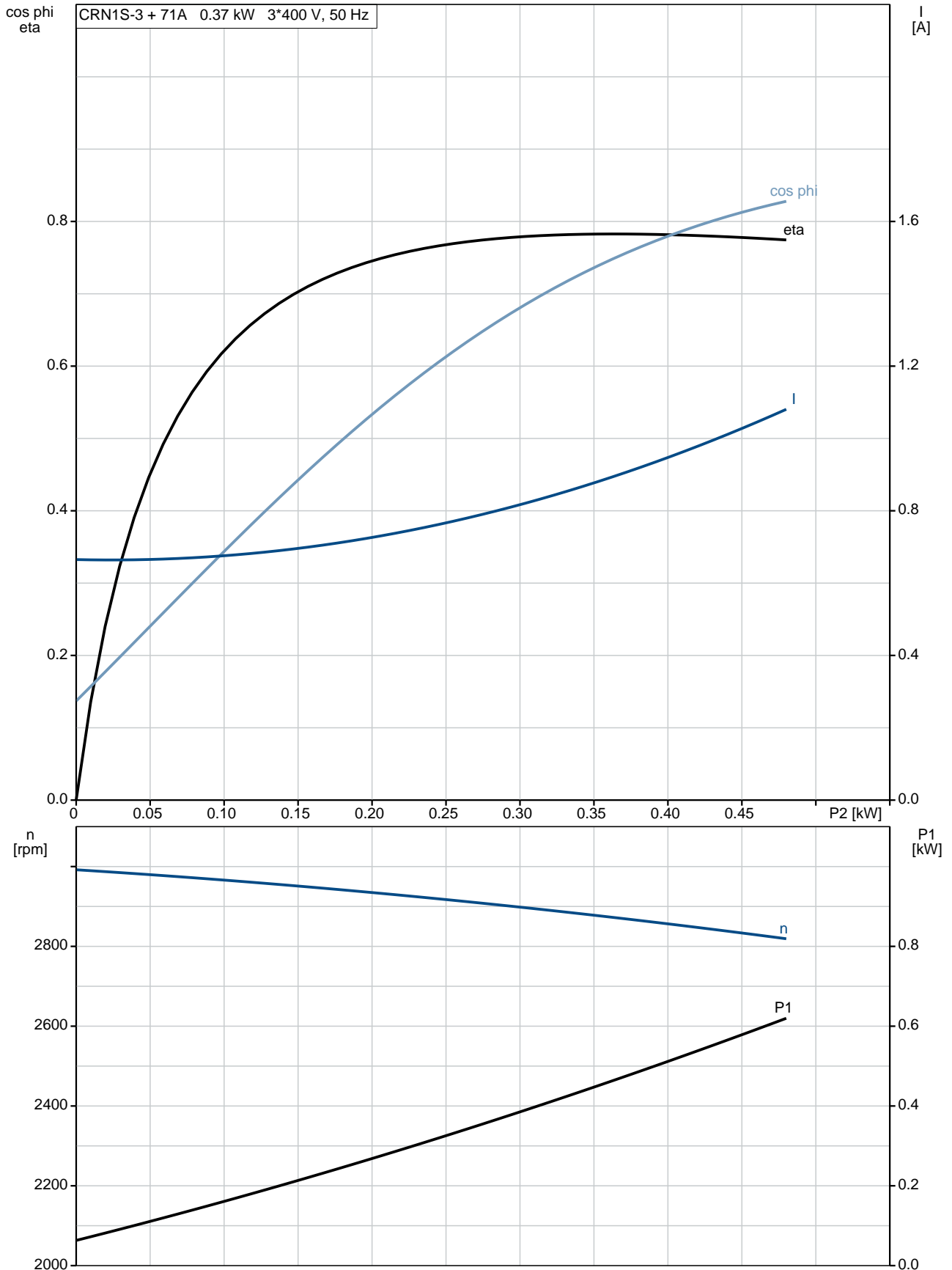

96516036 CRN 1S-3 A-P-A-E-HQQE 50 Hz

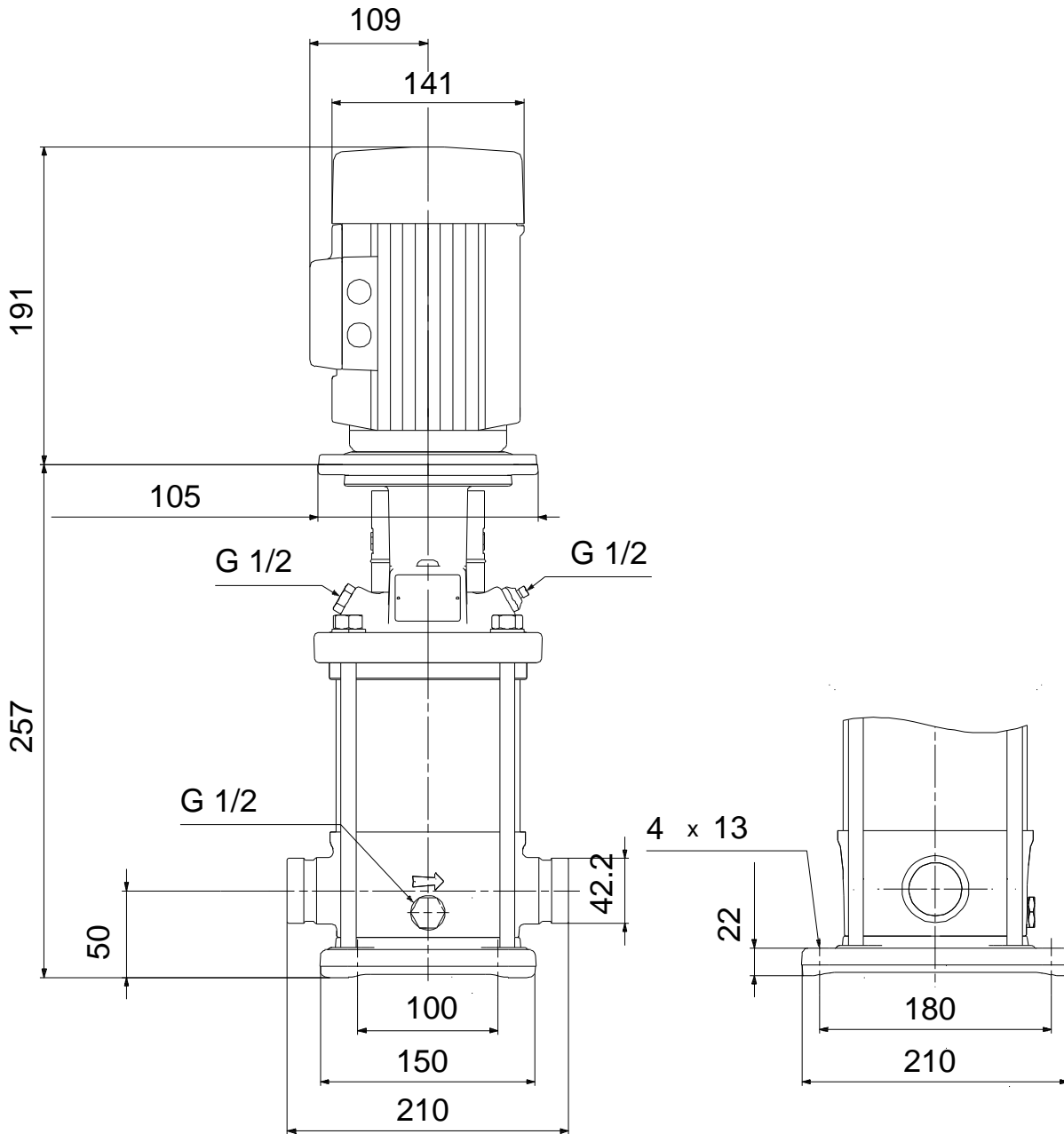

Note! All units are in [mm] unless others are stated.
Disclaimer: This simplified dimensional drawing does not show all details.