

Qty. Description

1 CRI 15-2 A-FGJ-A-V-HQQV



Note! Product picture may differ from actual product

Product No.: [96501686](#)

Vertical, multistage centrifugal pump with inlet and outlet ports on same the level (inline). Pump materials in contact with the liquid are in stainless steel. A cartridge shaft seal ensures high reliability, safe handling, and easy access and service. Power transmission is via a rigid split coupling. Pipe connection is via combined DIN-ANSI-JIS flanges.

The pump is fitted with a 1-phase, fan-cooled asynchronous motor.

Liquid:
Pumped liquid: Water
Liquid temperature range: -20 .. 90 °C
Selected liquid temperature: 20 °C
Density: 998.2 kg/m³

Qty.	Description
	<p>Technical: Pump speed on which pump data are based: 2730 rpm Rated flow: 17 m³/h Rated head: 20.2 m Pump orientation: Vertical Shaft seal arrangement: Single Code for shaft seal: HQQV Approvals: CE,EAC,UKCA Approvals for drinking water: WRAS Curve tolerance: ISO9906:2012 3B</p> <p>Materials: Base: Stainless steel EN 1.4408 AISI 316 Impeller: Stainless steel EN 1.4301 AISI 304 Bearing: SIC</p> <p>Installation: Maximum ambient temperature: 40 °C Maximum operating pressure: 16 bar Max pressure at stated temp: 16 bar / 90 °C 16 bar / -20 °C Type of connection: DIN / ANSI / JIS Size of inlet connection: DN 50 Size of outlet connection: DN 50 Pressure rating for connection: PN 25 Flange rating inlet: 300 lb Flange size for motor: FT115</p> <p>Electrical data: Motor standard: IEC Motor type: 90LC Rated power - P2: 2.2 kW Power (P2) required by pump: 2.2 kW Mains frequency: 50 Hz Rated voltage: 1 x 220-230/240 V Rated current: 14,0-13,6/12,6 A Starting current: 330 % Cos phi - power factor: 1.00 Rated speed: 2730/2720 rpm Motor efficiency at full load: 75 % Number of poles: 2 Enclosure class (IEC 34-5): 55 Dust/Jetting Insulation class (IEC 85): F Motor No: 85215708</p> <p>Controls: Frequency converter: NONE</p> <p>Others: Minimum efficiency index, MEI ≥: 0.70 Net weight: 53 kg Gross weight: 66 kg Shipping volume: 0.173 m³</p>

96501686 CRI 15-2 A-FGJ-A-V-HQQV 50 Hz

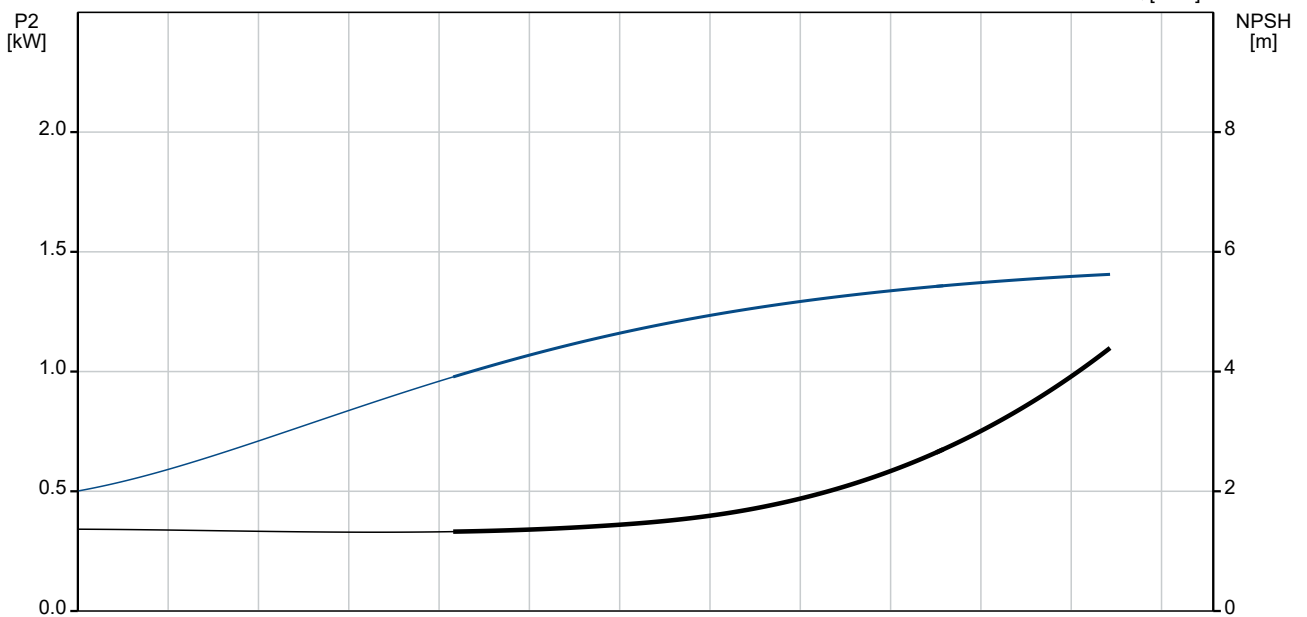
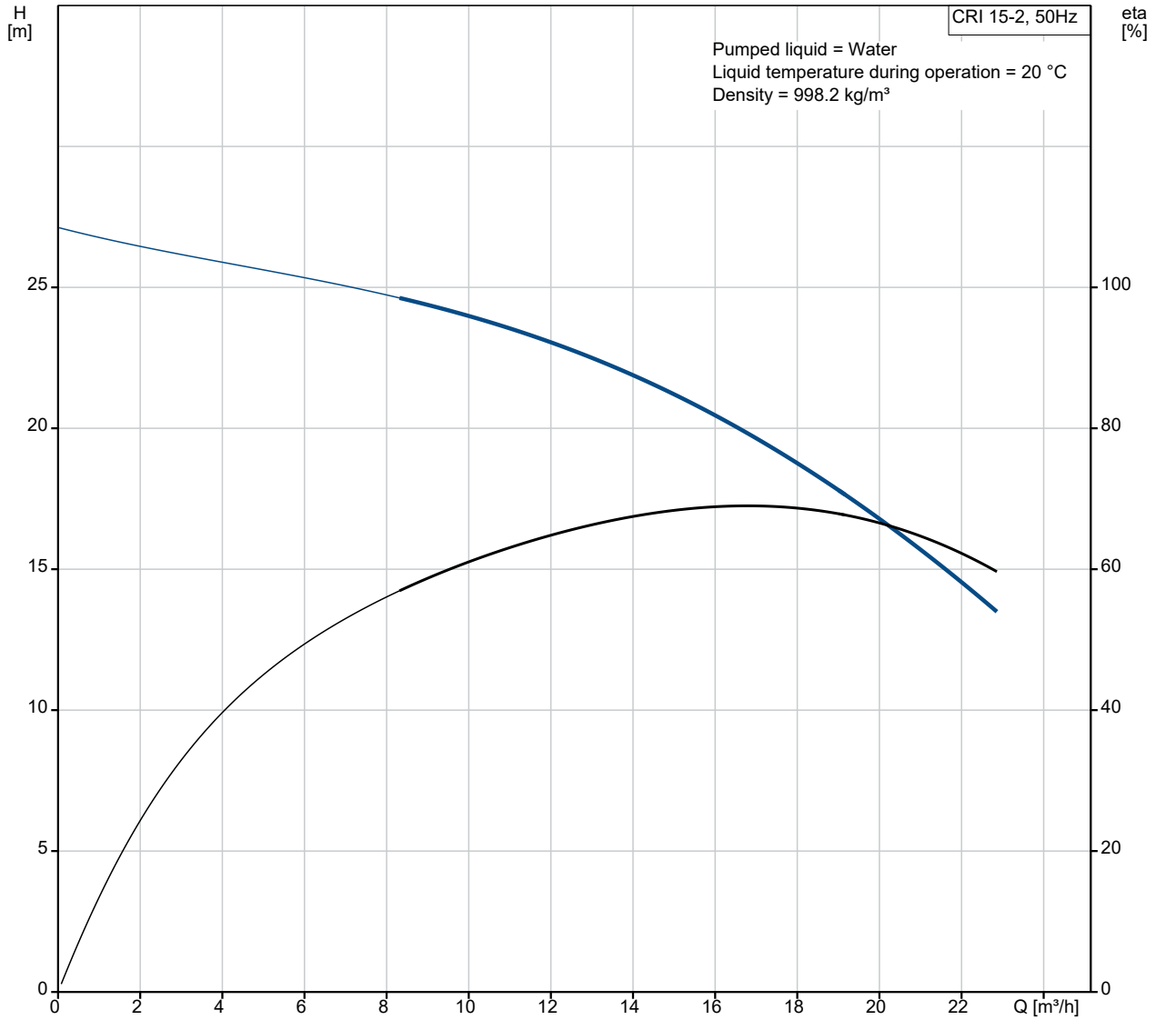

Description	Value
General information:	
Product name:	CRI 15-2 A-FGJ-A-V-HQQV
Product No:	96501686
EAN number:	5700396227184
Price:	
Technical:	
Pump speed on which pump data are based:	2730 rpm
Rated flow:	17 m ³ /h
Rated head:	20.2 m
Maximum head:	28 m
Stages:	2
Impellers:	2
Number of reduced-diameter impellers:	0
Low NPSH:	N
Pump orientation:	Vertical
Shaft seal arrangement:	Single
Code for shaft seal:	HQQV
Approvals:	CE,EAC,UKCA
Approvals for drinking water:	WRAS
Curve tolerance:	ISO9906:2012 3B
Pump version:	A
Model:	A
Materials:	
Base:	Stainless steel
Base:	EN 1.4408
Base:	AISI 316
Impeller:	Stainless steel
Impeller:	EN 1.4301
Impeller:	AISI 304
Material code:	A
Code for rubber:	V
Bearing:	SIC
Installation:	
Maximum ambient temperature:	40 °C
Maximum operating pressure:	16 bar
Max pressure at stated temp:	16 bar / 90 °C
Max pressure at stated temp:	16 bar / -20 °C
Type of connection:	DIN / ANSI / JIS
Size of inlet connection:	DN 50
Size of outlet connection:	DN 50
Pressure rating for connection:	PN 25
Flange rating inlet:	300 lb
Flange size for motor:	FT115
Connect code:	FGJ
Liquid:	
Pumped liquid:	Water
Liquid temperature range:	-20 .. 90 °C
Selected liquid temperature:	20 °C
Density:	998.2 kg/m ³
Electrical data:	
Motor standard:	IEC
Motor type:	90LC
Rated power - P2:	2.2 kW
Power (P2) required by pump:	2.2 kW
Mains frequency:	50 Hz
Rated voltage:	1 x 220-230/240 V
Rated current:	14,0-13,6/12,6 A

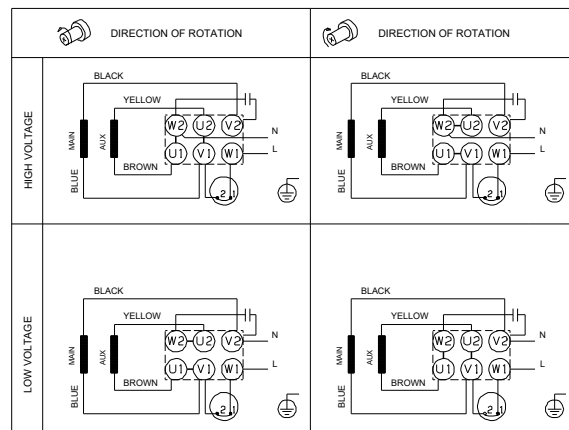
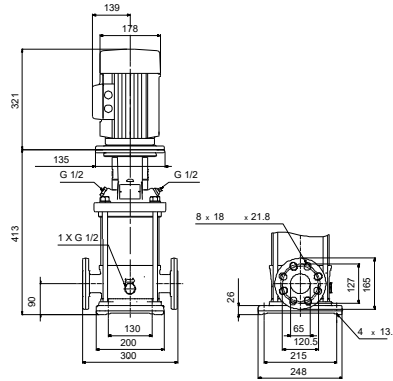
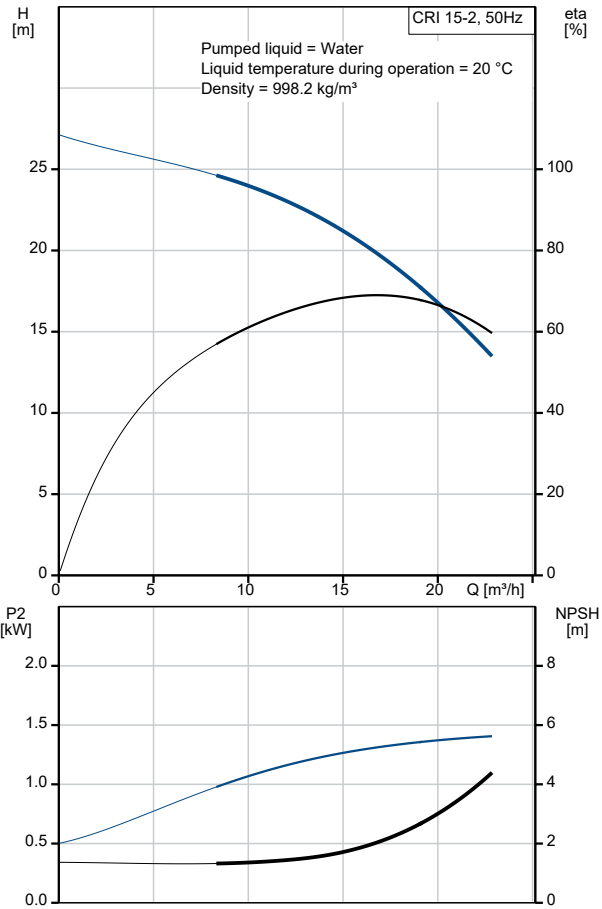



Company name:

Created by:

Phone:

Date:

15/07/2021

Description	Value
Starting current:	330 %
Cos phi - power factor:	1.00
Rated speed:	2730/2720 rpm
Motor efficiency at full load:	75 %
Number of poles:	2
Enclosure class (IEC 34-5):	55 Dust/Jetting
Insulation class (IEC 85):	F
Motor protec:	PTO
Motor No:	85215708
Controls:	
Frequency converter:	NONE
Others:	
Minimum efficiency index, MEI ≥:	0.70
Net weight:	53 kg
Gross weight:	66 kg
Shipping volume:	0.173 m ³

96501686 CRI 15-2 A-FGJ-A-V-HQQV 50 Hz

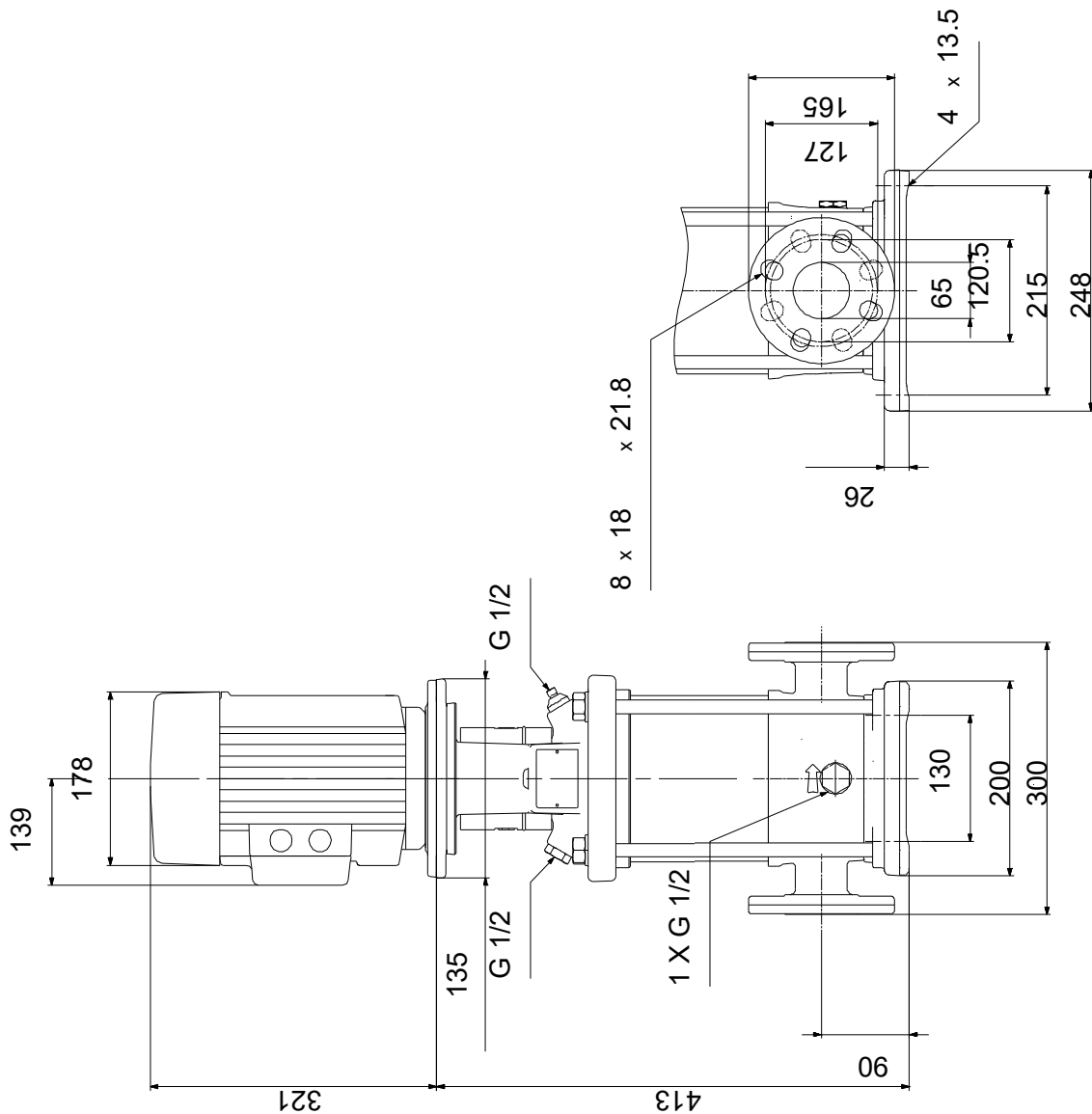

Note! All units are in [mm] unless others are stated.
Disclaimer: This simplified dimensional drawing does not show all details.

96501686 CRI 15-2 A-FGJ-A-V-HQQV 50 Hz

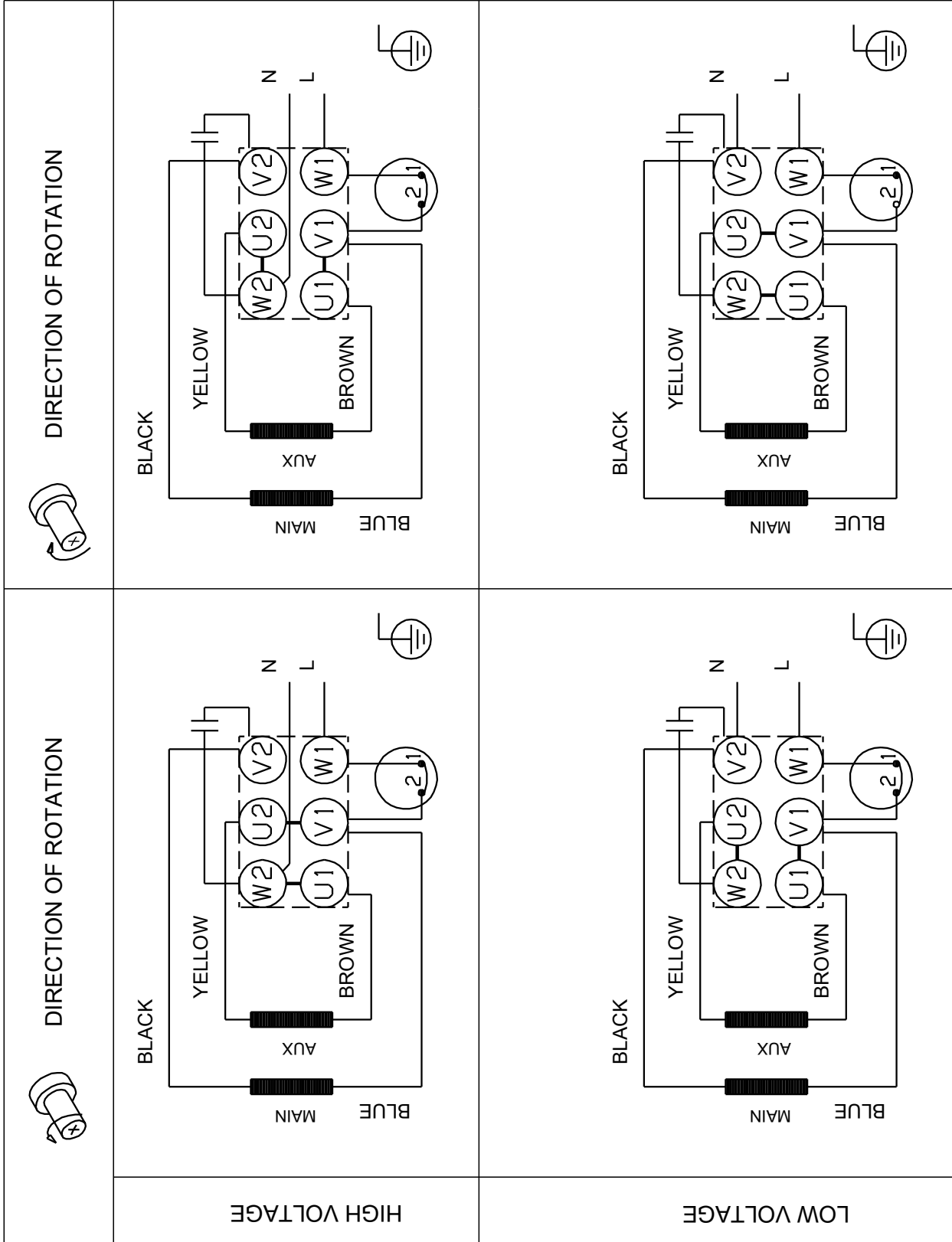

Note! All units are in [mm] unless others are stated.