

Qty. Description

1 **SP 360-3L G**



Note! Product picture may differ from actual product

Product No.: [96431009](#)

Multi-stage submersible pump for raw water supply, groundwater lowering, pressure boosting and various industrial jobs.

The pump is suitable for pumping clean, thin, non-aggressive liquids without solid particles or fibres.

Pump: The pump is made entirely of Cast iron DIN W.-Nr. EN-JL1040 and suitable for horizontal installation.

The pump is fitted with a built-in non-return valve.

Phase: The motor is a 3-phase motor with sand shield, liquid-lubricated bearings and pressure equalizing diaphragm.

Performance test according to ISO9906 2012 Grade 3B is available on request.

Liquid:

Pumped liquid: Water
 Maximum liquid temperature: 40 °C
 Max liquid t at 0.15 m/sec: 20 °C
 Selected liquid temperature: 20 °C
 Density: 998.2 kg/m³

Technical:

Type of impeller: L
 Shaft seal for motor: CER/CARBON
 Curve tolerance: ISO9906:2012 3B
 Motor version: T25

Materials:

Pump: Cast iron
 EN-JL1040
Impeller: Zinc-free bronze
 DIN W.-Nr. 2.1050.01
Motor: Cast iron
 DIN W.-Nr. 0.6025
 ASTM 35-40

Installation:

Flange standard: DIN
 Pump outlet: DN175
 Motor diameter: 8 inch

Electrical data:

Motor type: MMS8000
 Rated power - P2: 110 kW
 Mains frequency: 50 Hz



Company name:

Created by:

Phone:

Date:

12/11/2020

Qty.	Description
------	-------------

Rated voltage:	3 x 380-400-415 V
Rated current:	230-224-222 A
Cos phi - power factor:	0.89-0.87-0.84
Rated speed:	2870-2890-2900 rpm
Start. method:	direct-on-line
Enclosure class (IEC 34-5):	IP68
Built-in temp. transmitter:	no
Motor No:	96430676
Windings:	PVC

Others:	
Net weight:	523 kg
Shipping volume:	0.705 m ³
Country of origin:	IT
Custom tariff no.:	84137029

96431009 SP 360-3L G 50 Hz

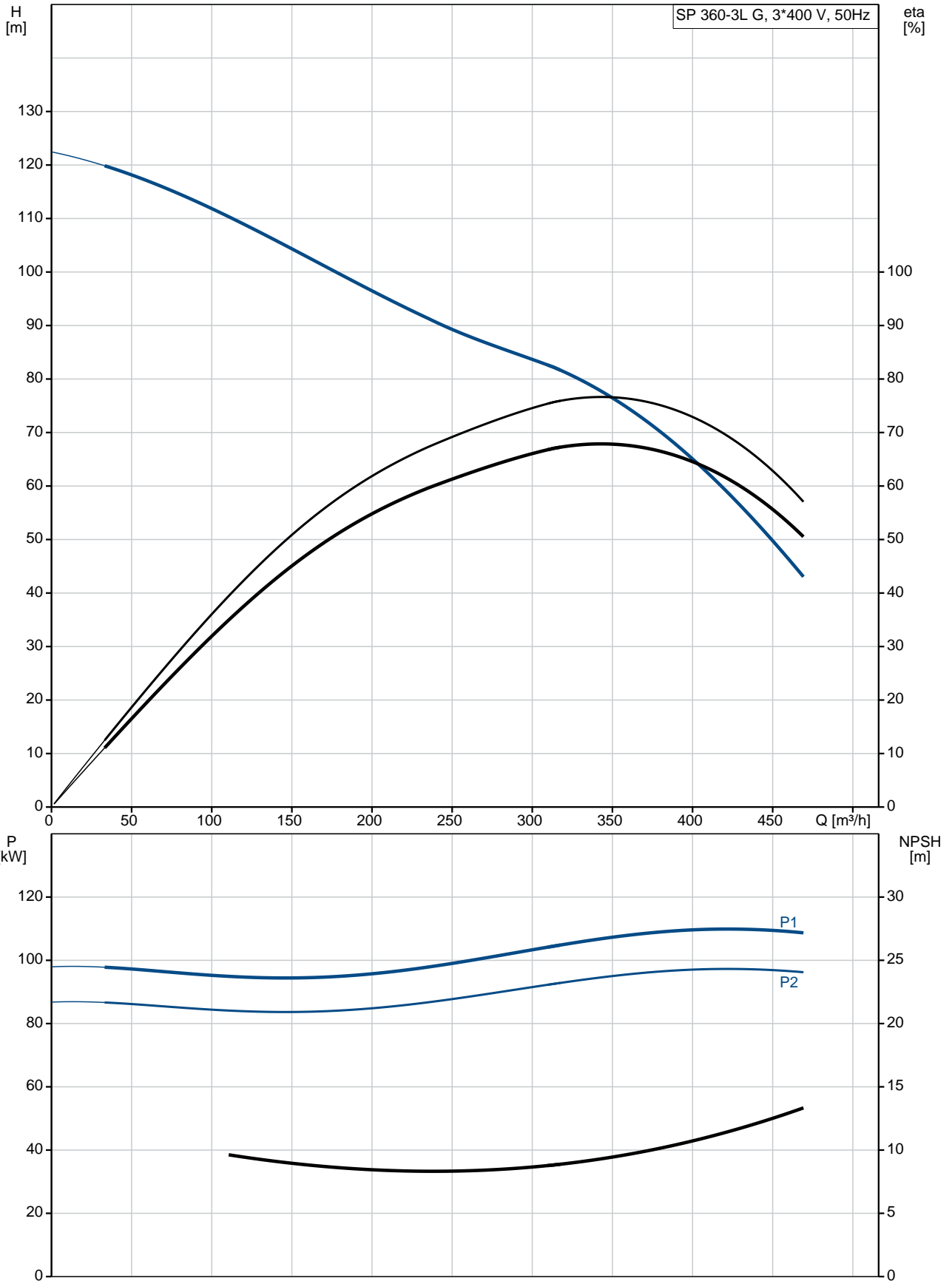

Description	Value
General information:	
Product name:	SP 360-3L G
Product No:	96431009
EAN number:	5700393033443
Technical:	
Stages:	3
Type of impeller:	L
Shaft seal for motor:	CER/CARBON
Curve tolerance:	ISO9906:2012 3B
Pump No:	96430911
Valve:	pump with built-in non-return valve
Motor version:	T25
Materials:	
Pump:	Cast iron
Pump:	EN-JL1040
Impeller:	Zinc-free bronze
Impeller:	DIN W.-Nr. 2.1050.01
Motor:	Cast iron
Motor:	DIN W.-Nr. 0.6025
Motor:	ASTM 35-40
Installation:	
Flange standard:	DIN
Pump outlet:	DN175
Motor diameter:	8 inch
Liquid:	
Pumped liquid:	Water
Maximum liquid temperature:	40 °C
Max liquid t at 0.15 m/sec:	20 °C
Selected liquid temperature:	20 °C
Density:	998.2 kg/m ³
Electrical data:	
Motor type:	MMS8000
Applic. motor:	GRUNDFOS
Rated power - P2:	110 kW
Mains frequency:	50 Hz
Rated voltage:	3 x 380-400-415 V
Rated current:	230-224-222 A
Cos phi - power factor:	0.89-0.87-0.84
Rated speed:	2870-2890-2900 rpm
Start. method:	direct-on-line
Enclosure class (IEC 34-5):	IP68
Motor protec:	NONE
Thermal protec:	external
Built-in temp. transmitter:	no
Motor No:	96430676
Windings:	PVC
Others:	
Net weight:	523 kg
Shipping volume:	0.705 m ³
Country of origin:	IT
Custom tariff no.:	84137029

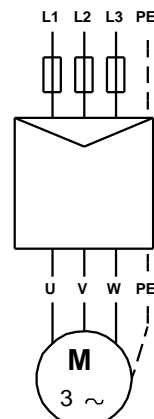
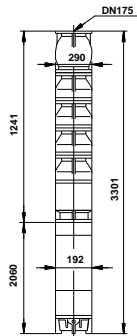
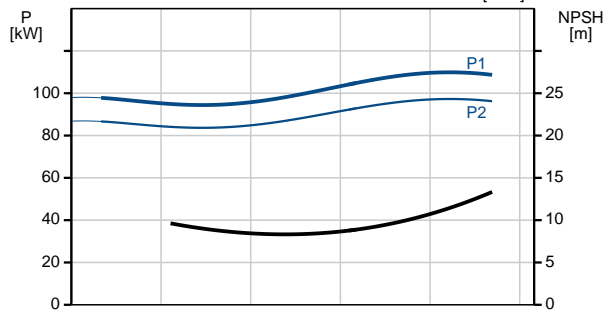
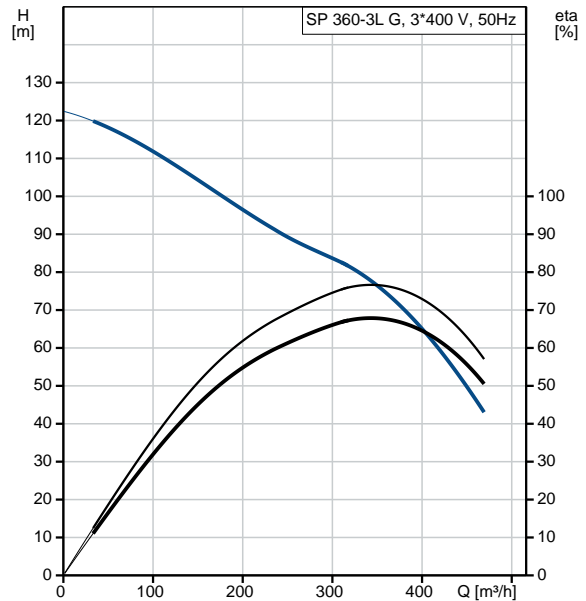

96431009 SP 360-3L G 50 Hz

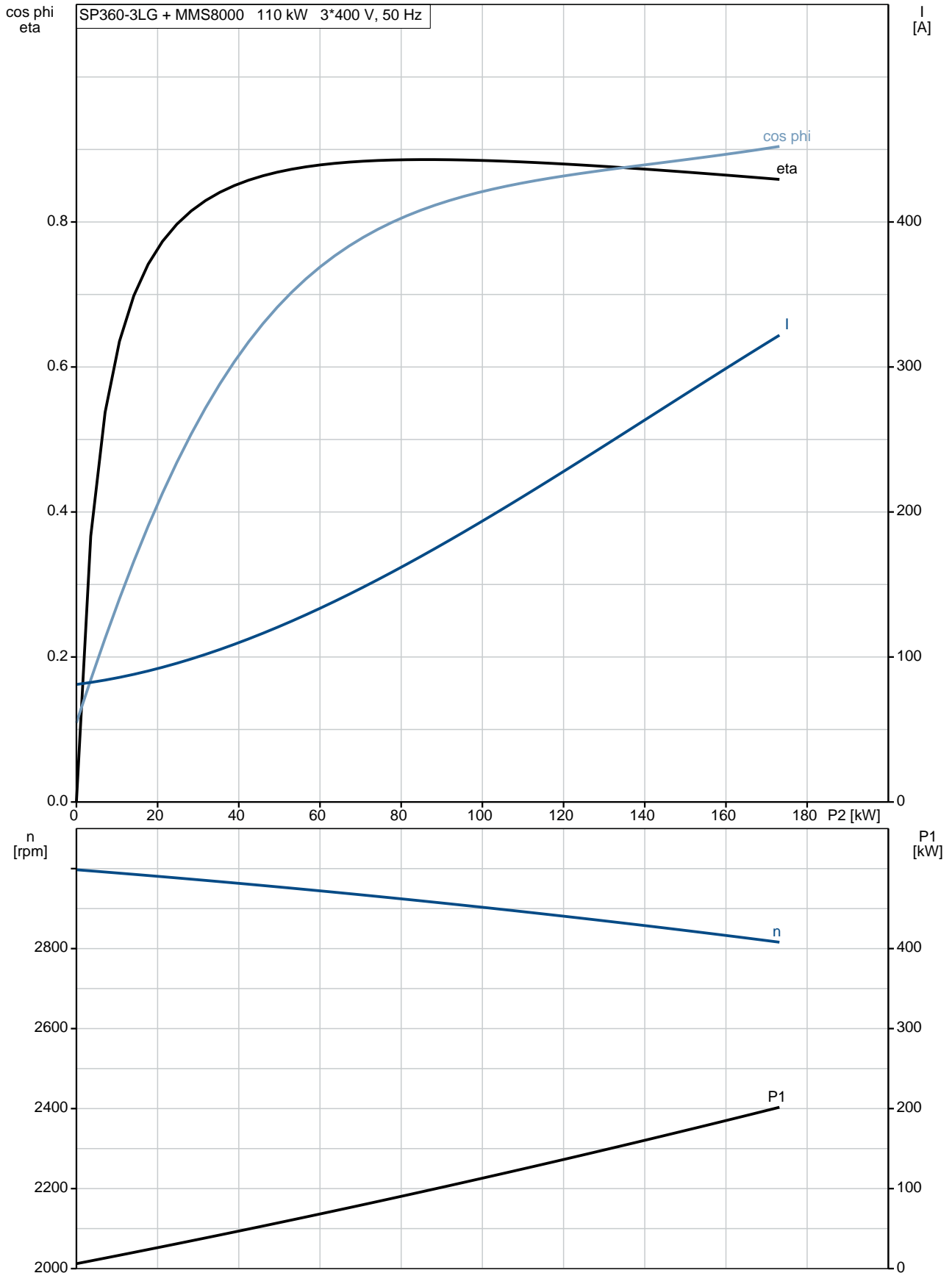

96431009 SP 360-3L G 50 Hz

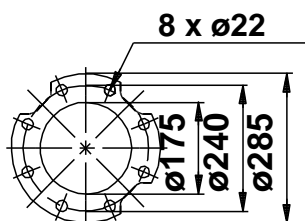
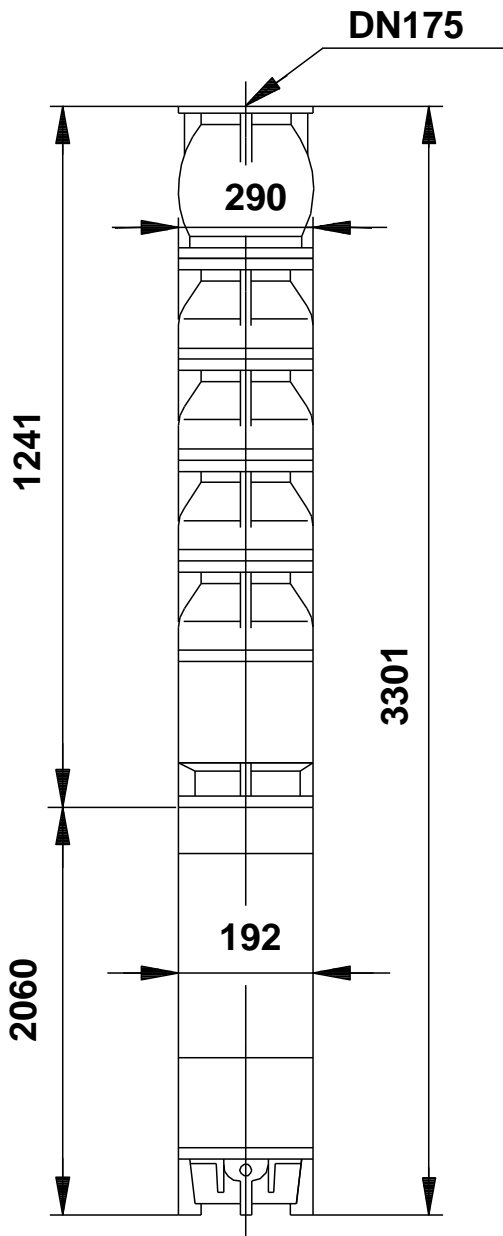

Note! All units are in [mm] unless others are stated.
Disclaimer: This simplified dimensional drawing does not show all details.

96431009 SP 360-3L G 50 Hz



Note! All units are in [mm] unless others are stated.