

Data sheet: Stratos GIGA B 32/1-25/1,6

Hydraulic data

Minimum efficiency index (MEI)	0.7
Maximum operating pressure p	16 bar
Min. fluid temperature T_{\min}	-20 °C
Max. fluid temperature T_{\max}	140 °C
Min. ambient temperature T_{\min}	0 °C
Max. ambient temperature T_{\max}	40 °C

Materials

Pump housing	5.1301, KTL-coated
Impeller	PPS-GF40
Shaft	1.4542
Shaft seal	AQ1EGG
Lantern	5.1301, KTL-coated

Installation dimensions

Pipe connection on the suction side <i>DN_s</i>	DN 50
Pipe connection on the pressure side <i>DN_d</i>	DN 32

Motor data

Mains connection	3~400 V, 50/60 Hz
Motor efficiency class	IE5
Rated power P_2	1.60 kW
Rated current I_N	2.70 A
Rated speed n	4620 rpm
Max. speed n_{\max}	4620 rpm
Emitted interference	EN 61800-3
Interference resistance	EN 61800-3
Insulation class	F
Protection class motor	IP55
Threaded cable connection	1 x M12x1.5

Approved liquids (other liquids upon request)

Heating water (as per VDI 2035)	yes
Heat carrier oil	Special version at additional charge
Cooling and cold water circulation systems	yes
Water-glycol mixtures (at 20 – 40 vol. % glycol and fluid temperature \leq 40 °C)	yes

Information for order placements

Brand	Wilo
Product description	Stratos GIGA B 32/1-25/1,6
EAN number	4048482778280
Article number	2189102
Net weight, approx. m	39 kg
Gross weight, approx. m	46.0 kg
Length with packaging	795 mm
Height with packaging	615 mm
Width with packaging	515 mm
Packaging property	Transport packaging
Packaging type	Cardboard box
Minimum order quantity	1

Dimensions and dimensions drawings: Stratos GIGA B 32/1-25/1,6

Stratos GIGA B 32/1-25/1,6

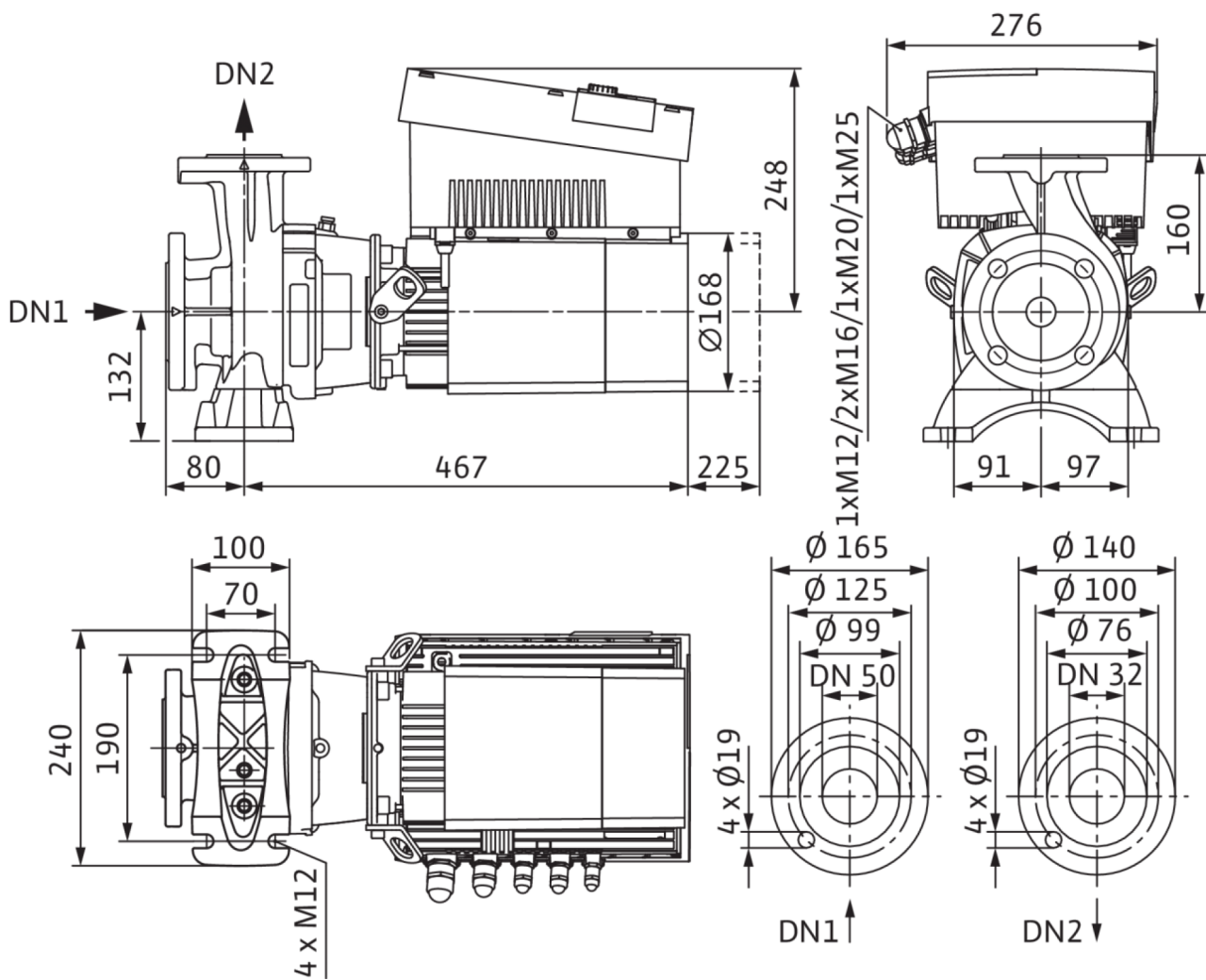

Pump curves: Stratos GIGA B 32/1-25/1,6

Stratos GIGA B 32/1-25/1,6

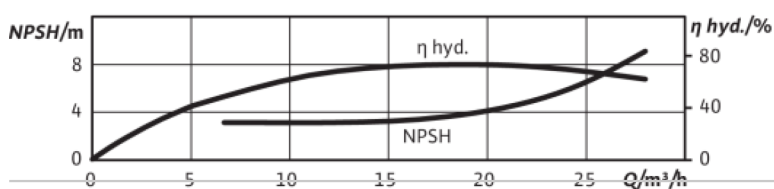
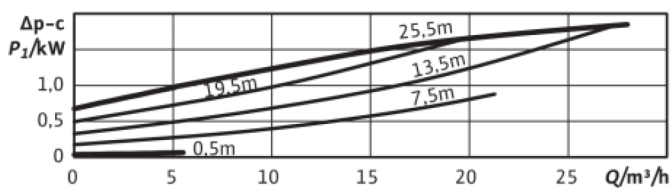
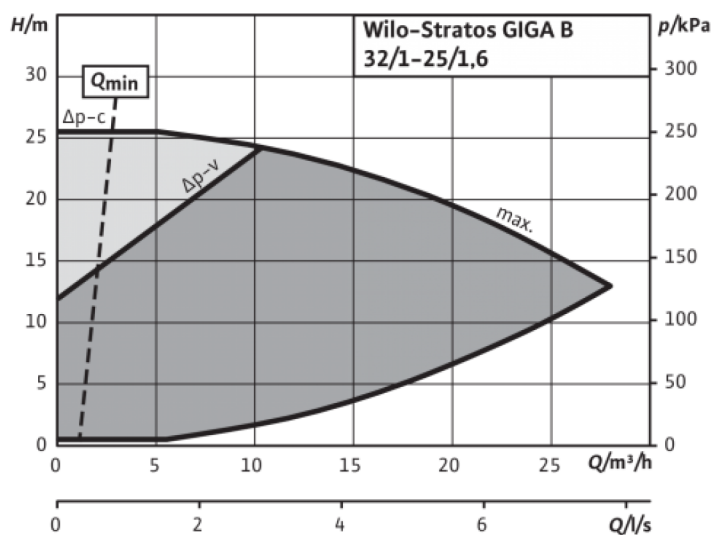
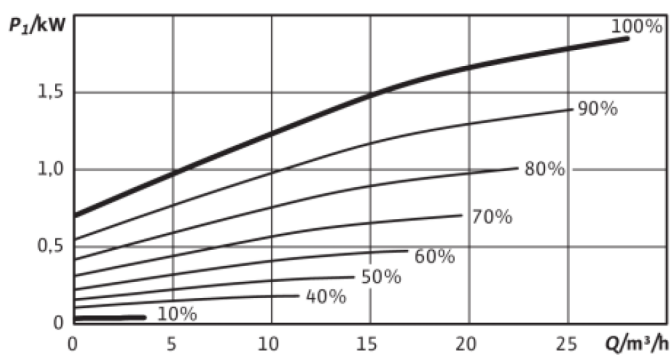
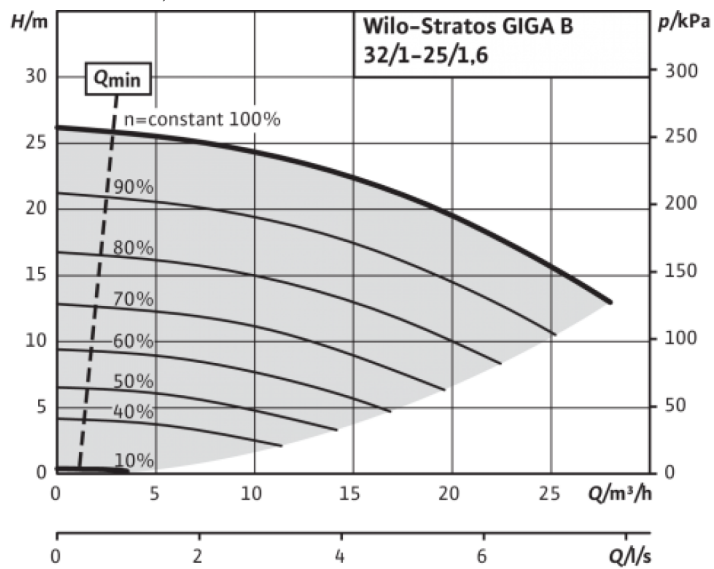

Wiring diagram: Stratos GIGA B 32/1-25/1,6

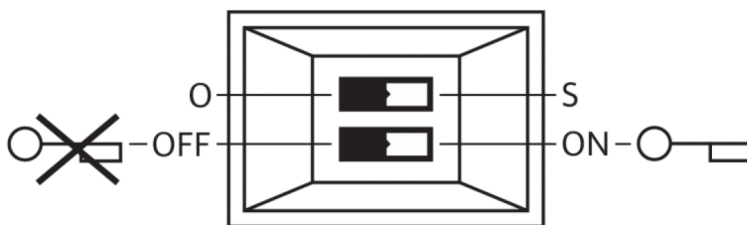
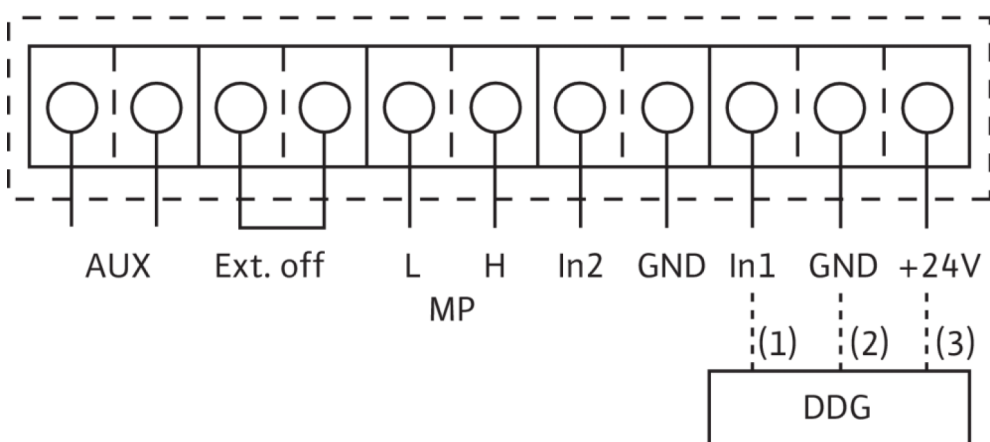
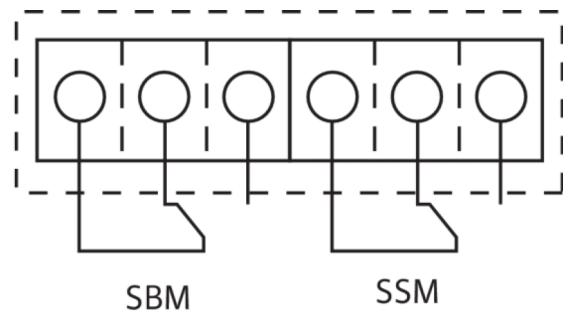
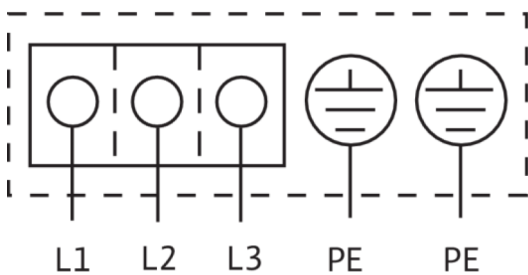

L1, L2, L3:
PE:
DDG:
In1 (1):
GND (2):
+ 24 V (3):
In2:
MP:
Ext. off:

Mains connection: 3-380 V - 3-480 V ($\pm 10\%$), 50/60 Hz
Protective conductor connection
Connection for differential pressure sensor
Actual value input 0 - 10 V/0 - 20 mA; 2 - 10 V/4 - 20 mA
Ground connection for In1 and In2
DC voltage output for an external consumer/sensor. Max load 60 mA
Setpoint input 0 - 10 V/0 - 20 mA; 2 - 10 V/4 - 20 mA
Multi-pump, interface for dual pump management

"Overriding Off" control input

The pump can be switched on or off via an external, potential-free contact (24 V DC/10 mA).
Potential-free collective run signal (changeover contact according to VDI 3814)
Potential-free collective fault signal (changeover contact according to VDI 3814)
External pump cycling (only with double pump operation). Pump cycling can be performed using an external, potential-free contact (24 V DC/10 mA)

1: Switchover between operation (O) and service mode (S)

2: Activate/deactivate the menu for access disable
IF-Module for connection to building automation

SBM:*
SSM:*
AUX:

DIP switch:

Optional:

* Load capacity of contacts for SBM and SSM:

min.: 12 V DC/10 mA

max.: 250 V AC/1 A