

## Data sheet: Stratos MAXO 40/0,5-8 PN 16

### Hydraulic data

Maximum operating pressure $PN$	16 bar
Head max $H_{max}$	8.0
Flow max $Q_{max}$	17.0
Minimum suction head at 50 °C	3
Minimum suction head at 95 °C	10
Minimum suction head at 110 °C	16
Min. fluid temperature $T_{min}$	-10 °C
Max. fluid temperature $T_{max}$	110 °C
Min. ambient temperature $T_{min}$	-10 °C
Max. ambient temperature $T_{max}$	40 °C

### Installation dimensions

Pipe connection on the suction side $DN_s$	DN 40
Pipe connection on the pressure side $DN_d$	DN 40
Port-to-port length $l_0$	220 mm

### Information for order placements

Brand	Wilo
Product description	Stratos MAXO 40/0,5-8 PN 16
EAN number	4048482797953
Article number	2186271
Net weight, approx. $m$	12 kg
Gross weight, approx. $m$	15.1 kg
Length with packaging	600 mm
Height with packaging	394 mm
Width with packaging	400 mm
Packaging property	Transport packaging
Packaging type	Cardboard box
Minimum order quantity	1

### Motor data

Energy efficiency index (EEI)	0.19
Rated power $P_2$	246.0 W
Min. speed $n_{min}$	450 rpm
Max. speed $n_{max}$	3750 rpm
Power consumption $P_{1 min}$	7.0 W
Power consumption $P_{1 max}$	280.0 W
Emitted interference	EN 61800-3;2004+A1;2012 /residential area (C1)
Interference resistance	EN 61800-3;2004+A1;2012 /industria l environment (C2)
Insulation class	F
Protection class	IPX4D

### Materials

Pump housing	EN-GJL-250
Impeller	PPS-GF40
Shaft	1.4122, DLC-coated
Bearing	Carbon, antimony-impregnated

Dimensions and dimensions drawings: Stratos MAXO 40/0,5-8 PN 16

Stratos MAXO (2186271)

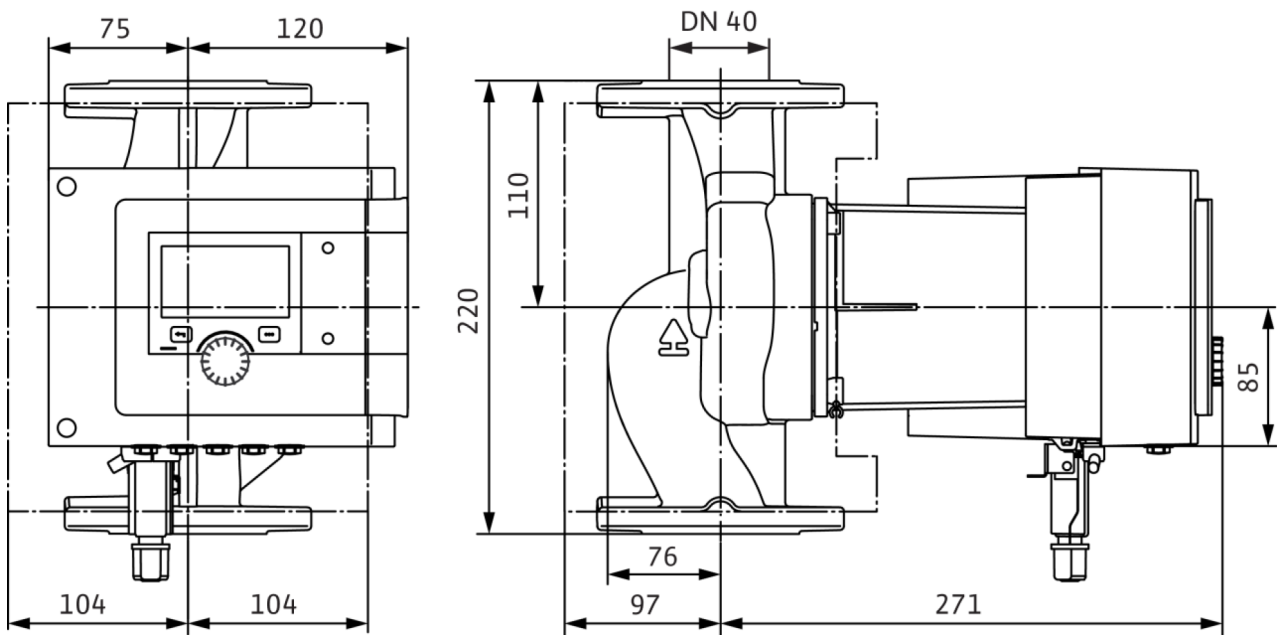

## Pump curves: Stratos MAXO 40/0,5-8 PN 16

Wilo-Stratos MAXO 40/0,5-8

