

Data sheet: Stratos MAXO 32/0,5-12 PN 16

Hydraulic data

Maximum operating pressure PN	16 bar
Head max H_{max}	10.0
Flow max Q_{max}	13.0
Minimum suction head at 50 °C	3
Minimum suction head at 95 °C	10
Minimum suction head at 110 °C	16
Min. fluid temperature T_{min}	-10 °C
Max. fluid temperature T_{max}	110 °C
Min. ambient temperature T_{min}	-10 °C
Max. ambient temperature T_{max}	40 °C

Installation dimensions

Pipe connection on the suction side DN_s	DN 32
Pipe connection on the pressure side DN_d	DN 32
Port-to-port length l_0	220 mm

Information for order placements

Brand	Wilo
Product description	Stratos MAXO 32/0,5-12 PN 16
EAN number	4048482797922
Article number	2186268
Net weight, approx. m	11 kg
Gross weight, approx. m	14.5 kg
Length with packaging	600 mm
Height with packaging	394 mm
Width with packaging	400 mm
Packaging property	Transport packaging
Packaging type	Cardboard box
Minimum order quantity	1

Motor data

Energy efficiency index (EEI)	0.18
Rated power P_2	275.0 W
Min. speed n_{min}	450 rpm
Max. speed n_{max}	4400 rpm
Power consumption $P_{1 min}$	7.0 W
Power consumption $P_{1 max}$	315.0 W
Emitted interference	EN 61800-3;2004+A1;2012 /residential area (C1)
Interference resistance	EN 61800-3;2004+A1;2012 /industrial environment (C2)
Insulation class	F
Protection class	IPX4D

Materials

Pump housing	EN-GJL-250
Impeller	PPS-GF40
Shaft	1.4122, DLC-coated
Bearing	Carbon, antimony-impregnated

Dimensions and dimensions drawings: Stratos MAXO 32/0,5-12 PN 16

Stratos MAXO (2186268)

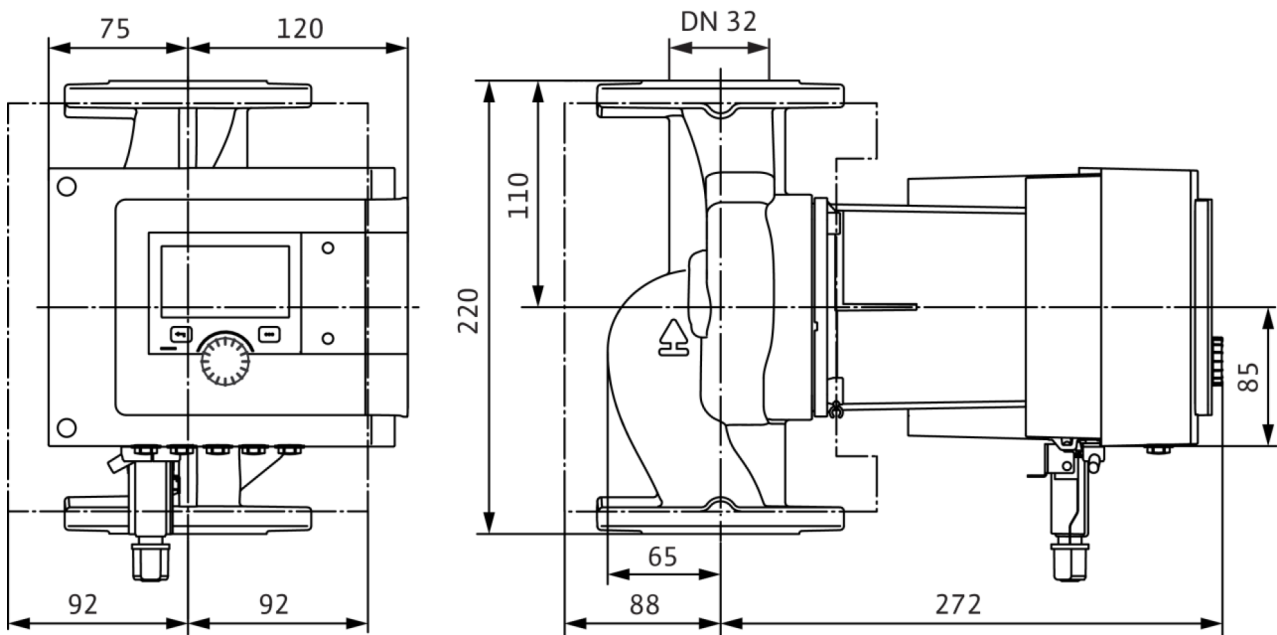

Pump curves: Stratos MAXO 32/0,5-12 PN 16

Wilo-Stratos MAXO 32/0,5-12

