

Data sheet: Stratos MAXO 30/0,5-4 PN16

Hydraulic data

Maximum operating pressure PN	16 bar
Head max H_{max}	4.0
Flow max Q_{max}	7.0
Minimum suction head at 50 °C	3
Minimum suction head at 95 °C	10
Minimum suction head at 110 °C	16
Min. fluid temperature T_{min}	-10 °C
Max. fluid temperature T_{max}	110 °C
Min. ambient temperature T_{min}	-10 °C
Max. ambient temperature T_{max}	40 °C

Installation dimensions

Pipe connection on the suction side DNs	G 2
Pipe connection on the pressure side DNd	G 2
Port-to-port length $l0$	180 mm

Information for order placements

Brand	Wilo
Product description	Stratos MAXO 30/0,5-4 PN16
EAN number	4048482797847
Article number	2186260
Net weight, approx. m	7 kg
Gross weight, approx. m	8.3 kg
Length with packaging	400 mm
Height with packaging	263 mm
Width with packaging	300 mm
Packaging property	Transport packaging
Packaging type	Cardboard box
Minimum order quantity	1

Motor data

Energy efficiency index (EEI)	0.18
Rated power P_2	69.0 W
Min. speed n_{min}	500 rpm
Max. speed n_{max}	2550 rpm
Power consumption $P_{1 min}$	7.0 W
Power consumption $P_{1 max}$	80.0 W
Emitted interference	EN 61800-3;2004+A1;2012 /residential area (C1)
Interference resistance	EN 61800-3;2004+A1;2012 /industrial environment (C2)
Insulation class	F
Protection class	IPX4D

Materials

Pump housing	EN-GJL-200
Impeller	PPS-GF40
Shaft	1.4122
Bearing	Carbon-graphite

Dimensions and dimensions drawings: Stratos MAXO 30/0,5-4 PN16

Stratos MAXO 30/0,5-4 PN 16

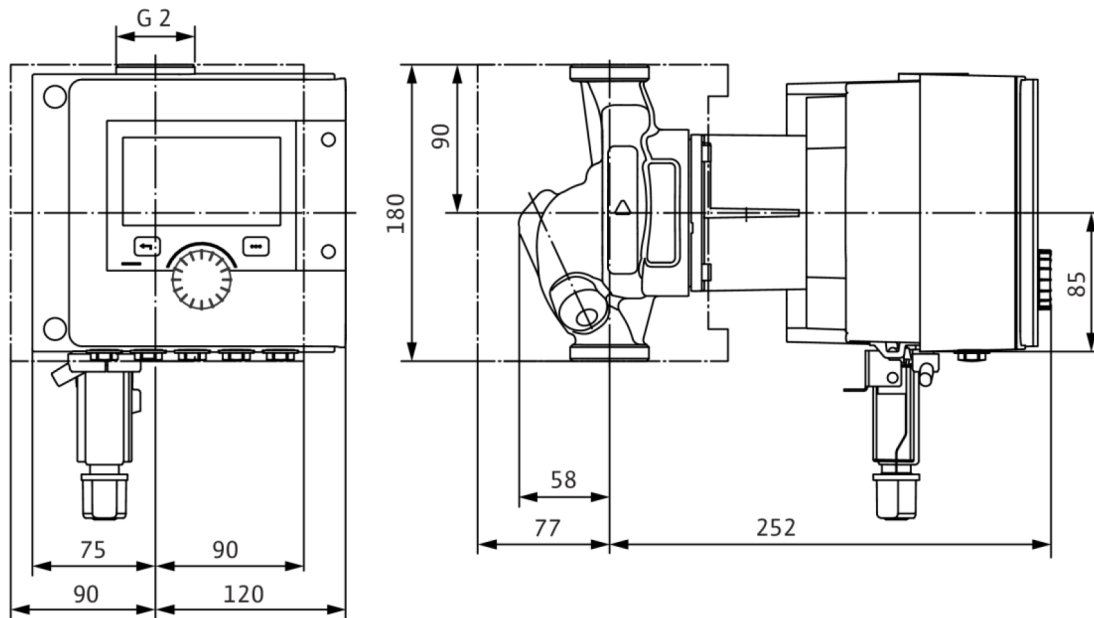

Pump curves: Stratos MAXO 30/0,5-4 PN16

Wilo-Stratos MAXO 25/0,5-4, 30/0,5-4

