

Data sheet: TOP-Z 50/7 (3~400 V, PN 6/10, RG)

Hydraulic data

Maximum operating pressure P_N	10 bar
Delivery head for Q_{min} $H_{Q_{min}}$	6.8 m
Max. volume flow Q_{max}	26.3 m ³ /h
Min. fluid temperature for HVAC applications T_{min}	-20 °C
Max. fluid temperature for HVAC applications T_{max}	110 °C
Min. fluid temperature for drinking water applications T_{min}	0
Max. fluid temperature for drinking water applications T_{max}	80
Max. fluid temperature for drinking water applications in short-time duty (2 hours) T_{max}	110 °C
Min. ambient temperature T_{min}	0 °C
Max. ambient temperature T_{max}	40 °C
Max. permitted total water hardness	3.57 mmol/l (20°dH) (3.21 mmol/l (18°dH) for 20/4 + 25/6)

Materials

Pump housing	Bronze
Impeller	PPE-GF30
Shaft	Stainless steel
Bearing	Carbon, synthetic resin-impregnated

Information for order placements

Brand	Wilo
Product description	TOP-Z 50/7 (3~400 V, PN 6/10, RG)
EAN number	4048482742762
Article number	2175522
Net weight, approx. m	19 kg
Gross weight, approx. m	20.7 kg
Length with packaging	430 mm
Height with packaging	290 mm
Width with packaging	230 mm
Packaging property	Transport packaging
Packaging type	Cardboard box
Minimum order quantity	1

Motor data

Mains connection	3~400 V, 50 Hz
Rated power P_2	350.0 W
Rated current I_N	1.38 A
Max. speed n_{max}	2700 1/min
Power consumption $P_{1 min}$	240.0 W
Power consumption $P_{1 max}$	680.0 W
Emitted interference	EN 61000-6-3
Interference resistance	EN 61000-6-2
Protection class motor	IPX4D
Insulation class	H
Threaded cable connection	2 x PG13.5
Motor protection	Internal protection overheating

Installation dimensions

Pipe connection on the suction side D_N s	DN 50
Pipe connection on the pressure side D_N d	DN 50
Port-to-port length L_0	280 mm

Tender text: TOP-Z 50/7 (3~400 V, PN 6/10, RG)

This circulator is suitable only for drinking water.

Can be used for domestic hot water circulation systems in the industry and building services.

Maintenance-free glandless circulator with threaded or flange connection, pre-selectable speed stages for power adjustment.

Equipment and function

- Manual power adjustment with 3 speed stages
- Pumps with 1~ motor:
 - P2 up to 90 W: internal protection against unacceptably high winding temperatures
 - P2 ≥ 180 W: Full motor protection with thermal winding contacts in conjunction with tripping unit (optional: SK 602N/SK 622N)
- Pumps with 3~ motor:
 - P2 up to 90 W: internal protection against unacceptably high winding temperatures
 - P2 ≥ 180 W: Full motor protection with thermal winding contacts in conjunction with tripping unit (optional: SK 602N/SK 622N)
- Mains connection 3~, 230 V with optional switching plug
- Pump housing in red brass or grey cast iron (stainless steel depending on type)
- PN 6/PN 10 combination flange (for DN 40 to DN 65)
- Thermal insulation shells

Operating data

Fluid media	Water
Fluid temperature T	-20 °C
Ambient temperature T	0 °C
Maximum operating pressure P_N	10 bar
Max. permitted total water hardness	3.57 mmol/l (20°dH) (3.21 mmol/l (18°dH) for 20/4 + 25/6)

Materials

Pump housing	Bronze
Impeller	PPE-GF30
Shaft	Stainless steel
Bearing	Carbon, synthetic resin-impregnated

Information for order placements

Brand	Wilo
Product description	TOP-Z 50/7 (3~400 V, PN 6/10, RG)
Net weight, approx. m	19 kg
Article number	2175522

Motor data

Emitted interference	EN 61000-6-3
Interference resistance	EN 61000-6-2
Mains connection	3~400 V, 50 Hz
Power consumption $P_{1\max}$	680.0 W
Max. speed n_{\max}	2700 1/min
Rated current I_N	1.38 A
Protection class motor	IPX4D
Threaded cable connection	2 x PG13.5

Installation dimensions

Pipe connection on the suction side DN_s	DN 50
Pipe connection on the pressure side DN_d	DN 50
Port-to-port length L_0	280 mm

Dimensions and dimensions drawings: TOP-Z 50/7 (3~400 V, PN 6/10, RG)

TOP-S

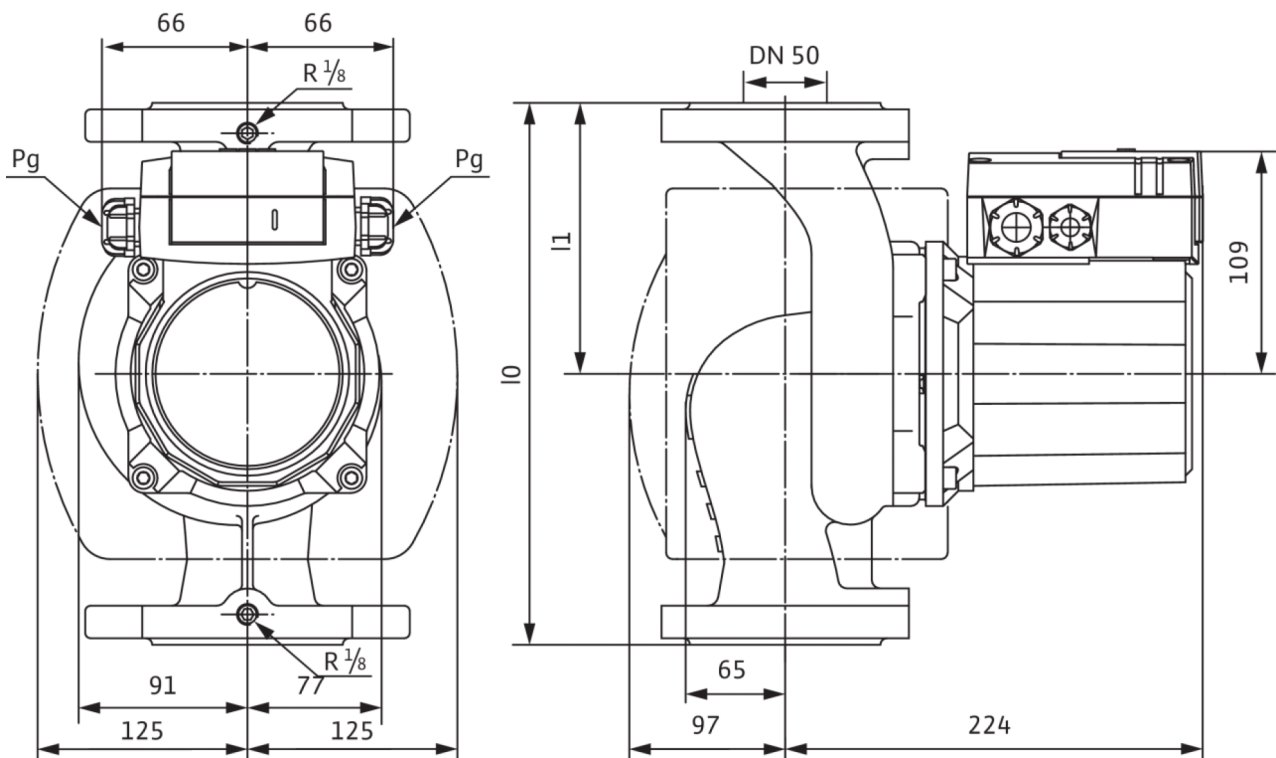

Wiring diagram: TOP-Z 50/7 (3~400 V, PN 6/10, RG)

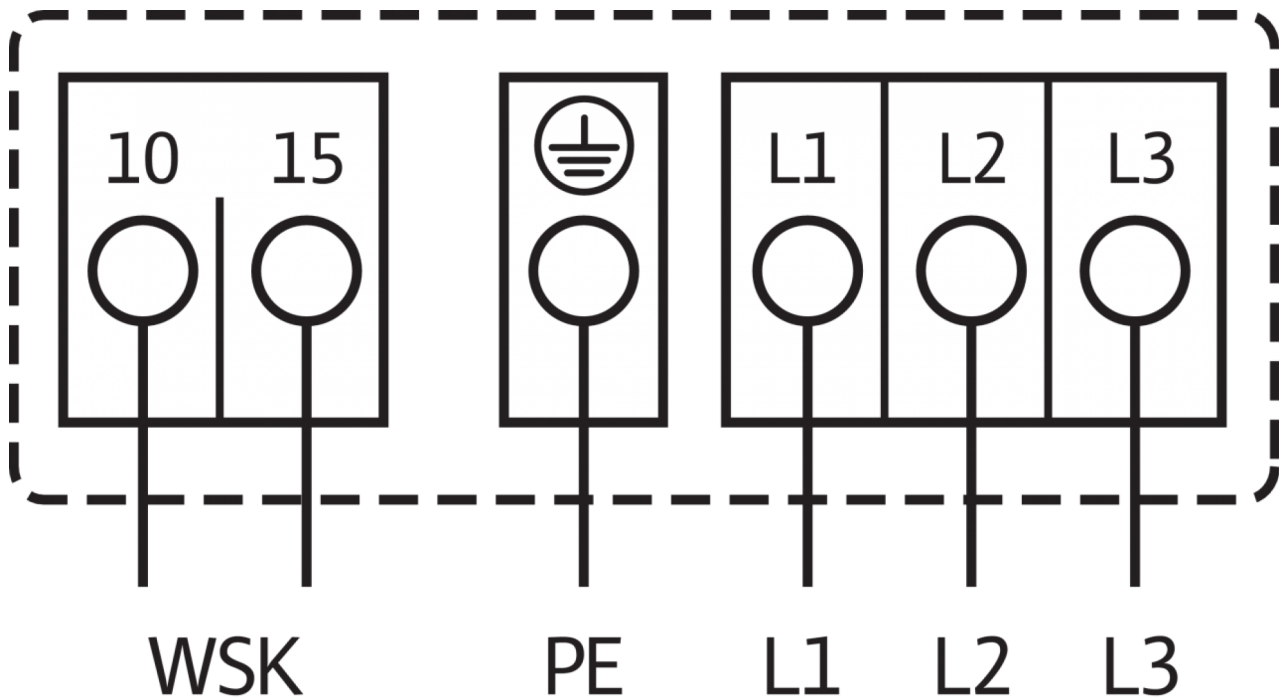

Mains connection, 3~400 V, 50 Hz

3~230 V, 50 Hz (optional with switching plug 3~230 V)

WSK = thermal winding contact

Full motor protection at all speed stages with optional tripping unit

SK 602N/SK 622N or other switchgear/control devices with WSK connection option

Triggering: External tripping at switchgear/control device

Reset: Automatic fault acknowledgement after cooling off of the motor

Automatic