

### Operating data

Fluid media	Water
Fluid temperature $T$	-20 °C
Ambient temperature $T$	-15 °C
Maximum operating pressure $P_N$	16 bar
Note on dimensioning	16 bar to 120°C, 13 bar to 140°C
Minimum efficiency index (MEI)	0.4

### Motor data

Mains connection	3~400 V, 50 Hz
Voltage tolerance	±10 %
Motor efficiency class	IE3
Rated power $P_2$	3.00 kW
Rated current $I_N$	6.15 A
Rated speed $n$	2900 1/min
Power factor $\cos \varphi$	0.79
Motor efficiency $\eta_M$ 50%	82.5 Percentage
Motor efficiency $\eta_M$ 75%	84.6 Percentage
Motor efficiency $\eta_M$ 100%	87.1 Percentage
Motor winding up to 3 kW	-
Motor winding from 4 kW	-
Insulation class	F
Protection class motor	IP55
Motor protection	no

### Installation dimensions

Pipe connection on the suction side $DN_s$	DN 32
Pipe connection on the pressure side $DN_d$	DN 32
Port-to-port length $L_0$	320 mm

### Hydraulic data

Minimum efficiency index (MEI)	0.4
Max. operating pressure $p$	16 bar
Maximum operating pressure $P_N$	16 bar
Min. fluid temperature $T_{\min}$	-20 °C
Max. fluid temperature $T_{\max}$	140 °C
Max. ambient temperature $T_{\max}$	40 °C
Note on dimensioning	16 bar to 120°C, 13 bar to 140°C

### Materials

Pump housing	5.1301/EN-GJL-250 KTL-coated
Impeller	EN-GJL-200 (GG-20) Cast iron
Shaft	Stainless steel
Mechanical seal	AQ1EGG
Lantern	5.1301/EN-GJL-250 KTL-coated

CronoLine-IL 32/140-1,5/2 - 32/170-4/2, 2-pole, 50 Hz

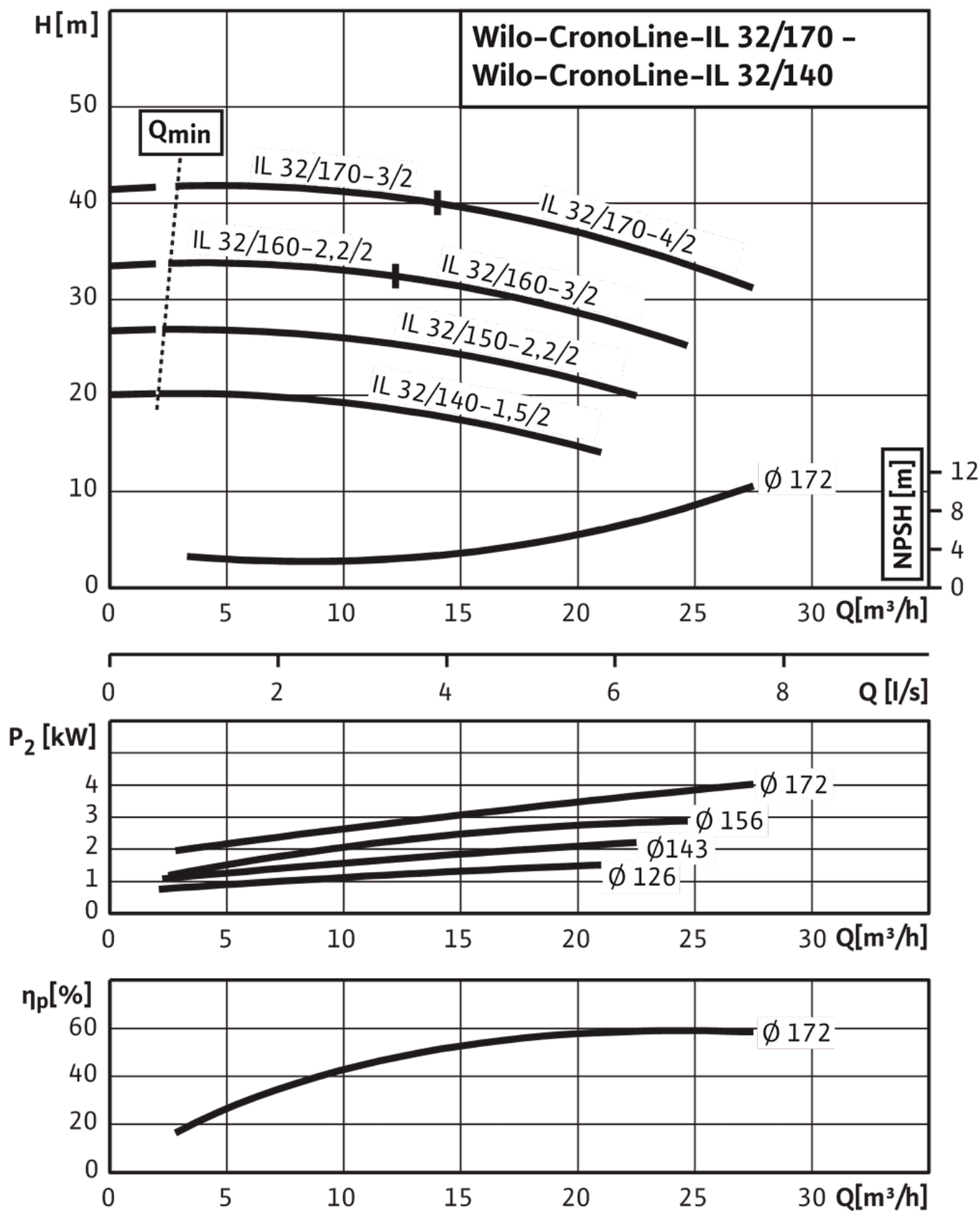

CronoLine-IL 32/160-3/2

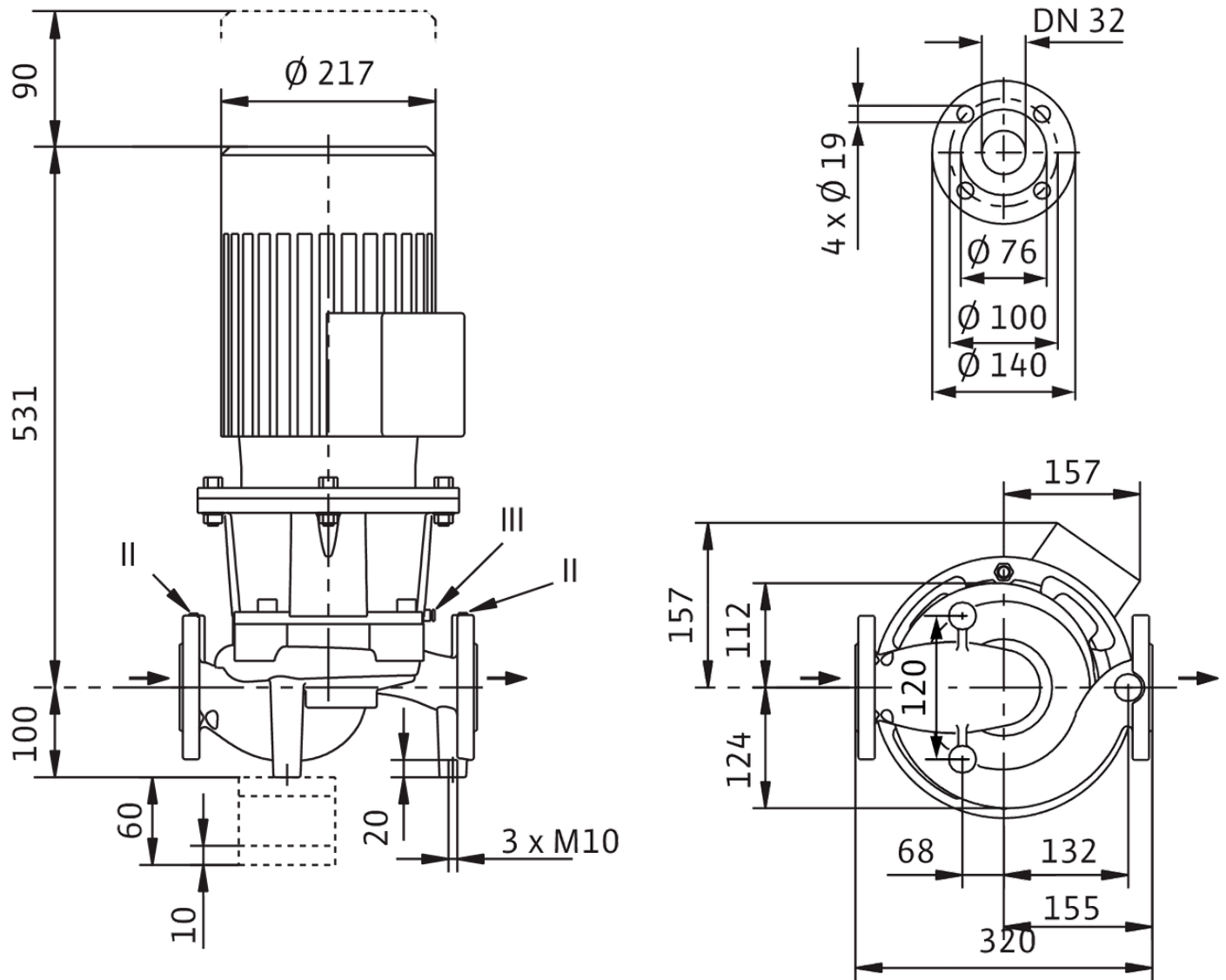

II Pressure measuring connection  $R^{1/8}$ ; III Ventilation  $R^{1/8}$

CronoLine-IL 32/160-3/2

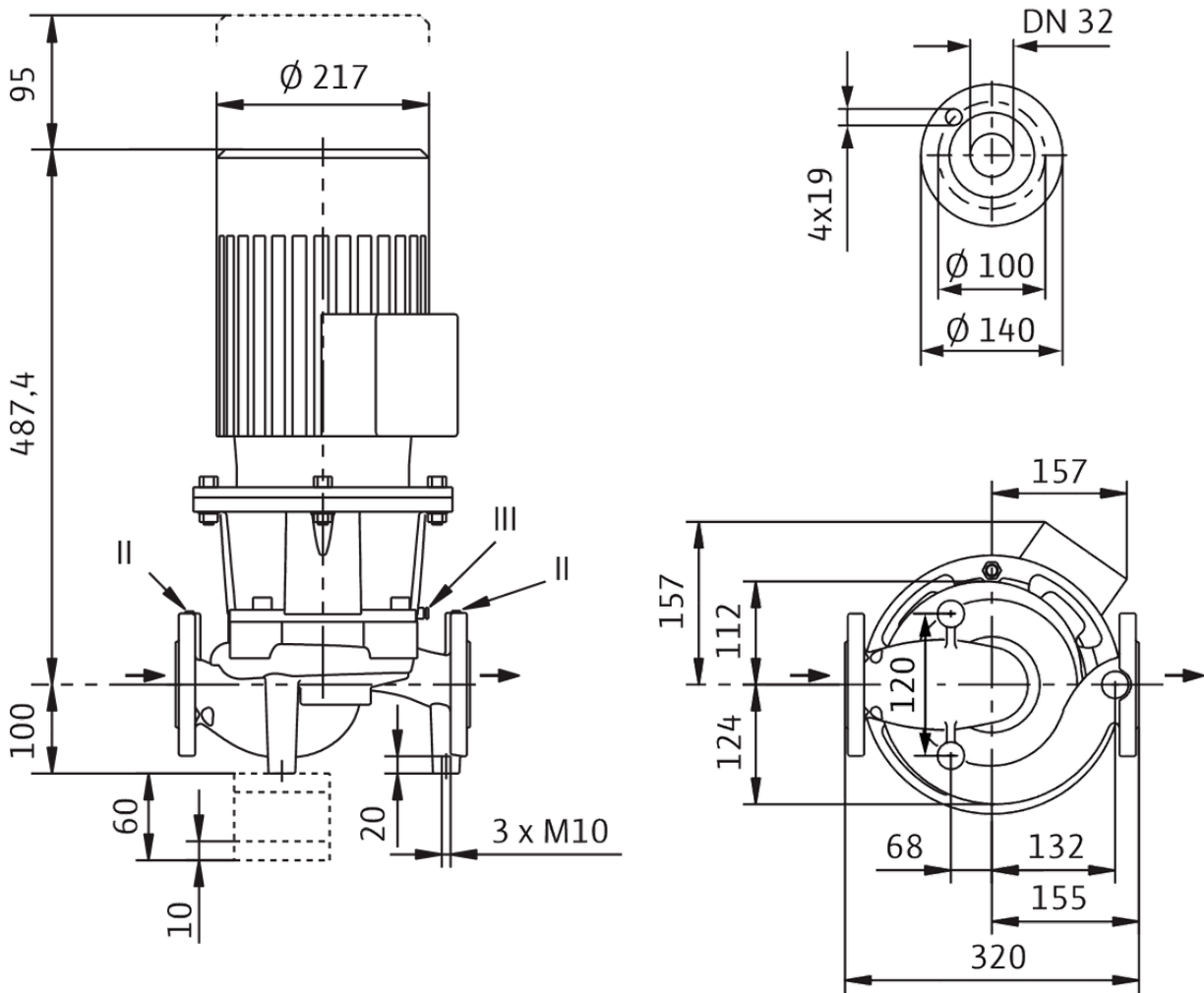

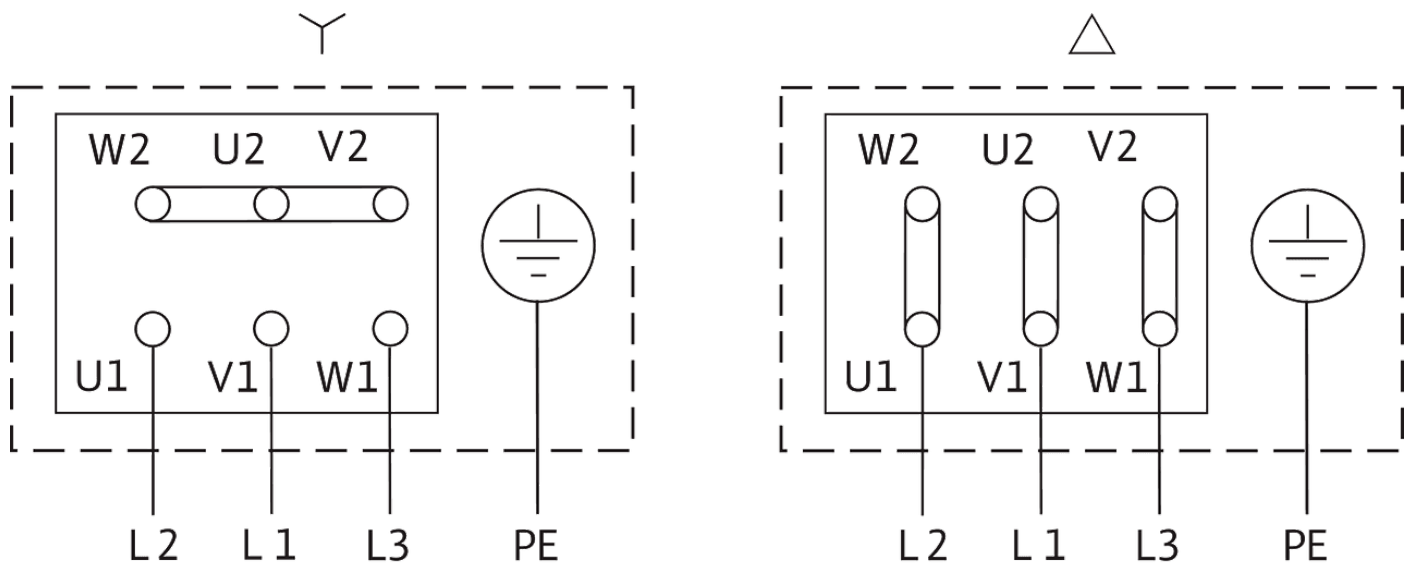

Δ: Connection diagram delta connection

Y: Connection diagram star connection

Motor protection switch required on-site. Check the direction of rotation! To change the direction of rotation, exchange any two phases.

$P_2 \leq 3 \text{ kW}$  3~400 V Y

3~230 V Δ

$P_2 \geq 4 \text{ kW}$  3~690 V Y

3~400 V Δ

After removing the bridges, Y-Δ start is possible.

#### Product data

Brand	Wilo
Product description	CronoLine-IL 32/160-3/2
Article number	2120865
EAN number	4048482217178
Colour	Green
Minimum order quantity	1
Date of sales availability	2015-09-01

#### Dimension, weight

Length with packaging	795 mm
Length <i>L</i>	587 mm
Height with packaging	465 mm
Height <i>H</i>	324 mm
Width with packaging	395 mm
Width <i>W</i>	284 mm
Gross weight, approx. <i>m</i>	63.8 kg
Net weight, approx. <i>m</i>	59 kg

#### Packaging

Number per layer	1
Packaging property	Transport packaging
Packaging type	Cardboard box
Pieces per pallet	1

Single-stage glanded centrifugal pump with in-line design for pipe installation or installation on a base. Low-vibration and low-noise monobloc design with lantern and rigidly connected standard flange motor. With forced-flow circulation, bidirectional bellows mechanical seal and cavitation-reducing impeller. Flange with R 1/8 pressure measuring connections.

Pump housing and lantern are cataphoretic-coated.

Motors in IE3 technology as standard. Pump with motor  $\geq 5.5$  kW ...  $\leq 55$  kW are equipped as standard with a PTC thermistor sensor for motor protection.

### Operating data

Fluid media	Water
Fluid temperature $T$	-20 °C
Ambient temperature $T$	-15 °C
Maximum operating pressure $P_N$	16 bar
Note on dimensioning	16 bar to 120°C, 13 bar to 140°C
Minimum efficiency index (MEI)	0.4

### Motor data

Motor efficiency class	IE3
Mains connection	3~400 V, 50 Hz
Voltage tolerance	$\pm 10$ %
Rated power $P_2$	3000.0 W
Rated speed $n$	2900 1/min
Rated current $I_N$	6.15 A
Power factor $\cos \varphi$	0.79
Motor efficiency $\eta_M$ 50%	82.5 Percentage
Motor efficiency $\eta_M$ 75%	84.6 Percentage
Motor efficiency $\eta_M$ 100%	87.1 Percentage
Insulation class	F
Protection class	IP55

### Materials

Pump housing	5.1301/EN-GJL-250 KTL-coated
Impeller	Cast iron
Shaft	Stainless steel
Shaft seal	AQ1EGG
Lantern	5.1301/EN-GJL-250 KTL-coated

### Installation dimensions

Pipe connection on the suction side $DN_s$	DN 32
Pipe connection on the pressure side $DN_d$	DN 32

### Information for order placements

Brand	Wilo
-------	------

**Information for order placements**

<b>Product description</b>	CronoLine-IL 32/160-3/2
<b>Net weight, approx. <i>m</i></b>	59 kg
<b>Article number</b>	2120865