

Operating data

Fluid media	Water
Fluid temperature T	-20 °C
Ambient temperature T	-15 °C
Maximum operating pressure P_N	16 bar
Note on dimensioning	16 bar to 120°C, 13 bar to 140°C
Minimum efficiency index (MEI)	0.4

Motor data

Mains connection	3~400 V, 50 Hz
Voltage tolerance	±10 %
Motor efficiency class	IE3
Rated power P_2	2.20 kW
Rated current I_N	4.50 A
Rated speed n	2900 1/min
Power factor $\cos \varphi$	0.81
Motor efficiency η_M 50%	84.3 Percentage
Motor efficiency η_M 75%	85.5 Percentage
Motor efficiency η_M 100%	85.9 Percentage
Motor winding up to 3 kW	-
Motor winding from 4 kW	-
Insulation class	F
Protection class motor	IP55
Motor protection	no

Installation dimensions

Pipe connection on the suction side DN_s	DN 32
Pipe connection on the pressure side DN_d	DN 32
Port-to-port length L_0	320 mm

Hydraulic data

Minimum efficiency index (MEI)	0.4
Max. operating pressure p	16 bar
Maximum operating pressure P_N	16 bar
Min. fluid temperature T_{\min}	-20 °C
Max. fluid temperature T_{\max}	140 °C
Max. ambient temperature T_{\max}	40 °C
Note on dimensioning	16 bar to 120°C, 13 bar to 140°C

Materials

Pump housing	5.1301/EN-GJL-250 KTL-coated
Impeller	EN-GJL-200 (GG-20) Cast iron
Shaft	Stainless steel
Mechanical seal	AQ1EGG
Lantern	5.1301/EN-GJL-250 KTL-coated

CronoLine-IL 32/140-1,5/2 - 32/170-4/2, 2-pole, 50 Hz

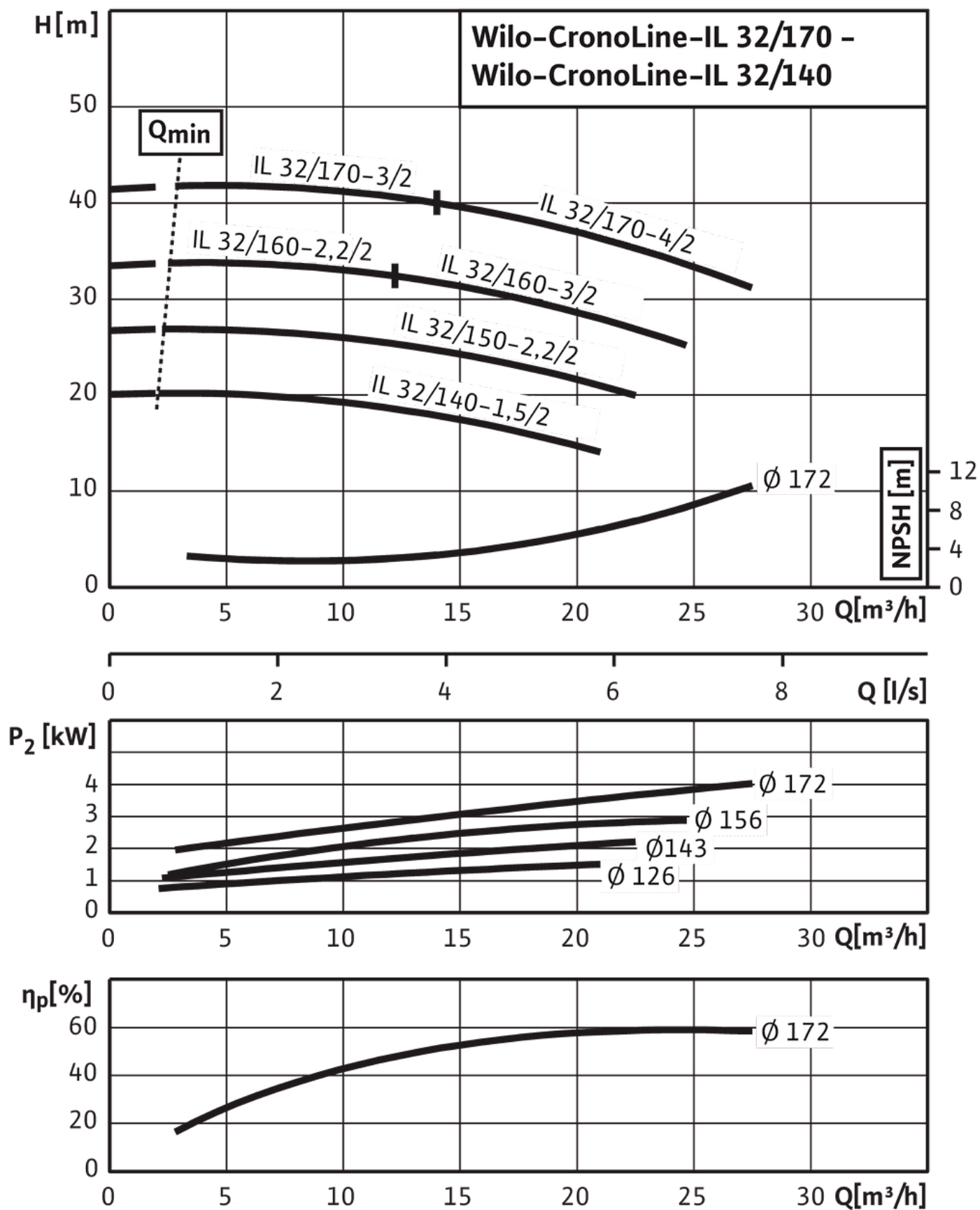

CronoLine-IL 32/160-2,2/2

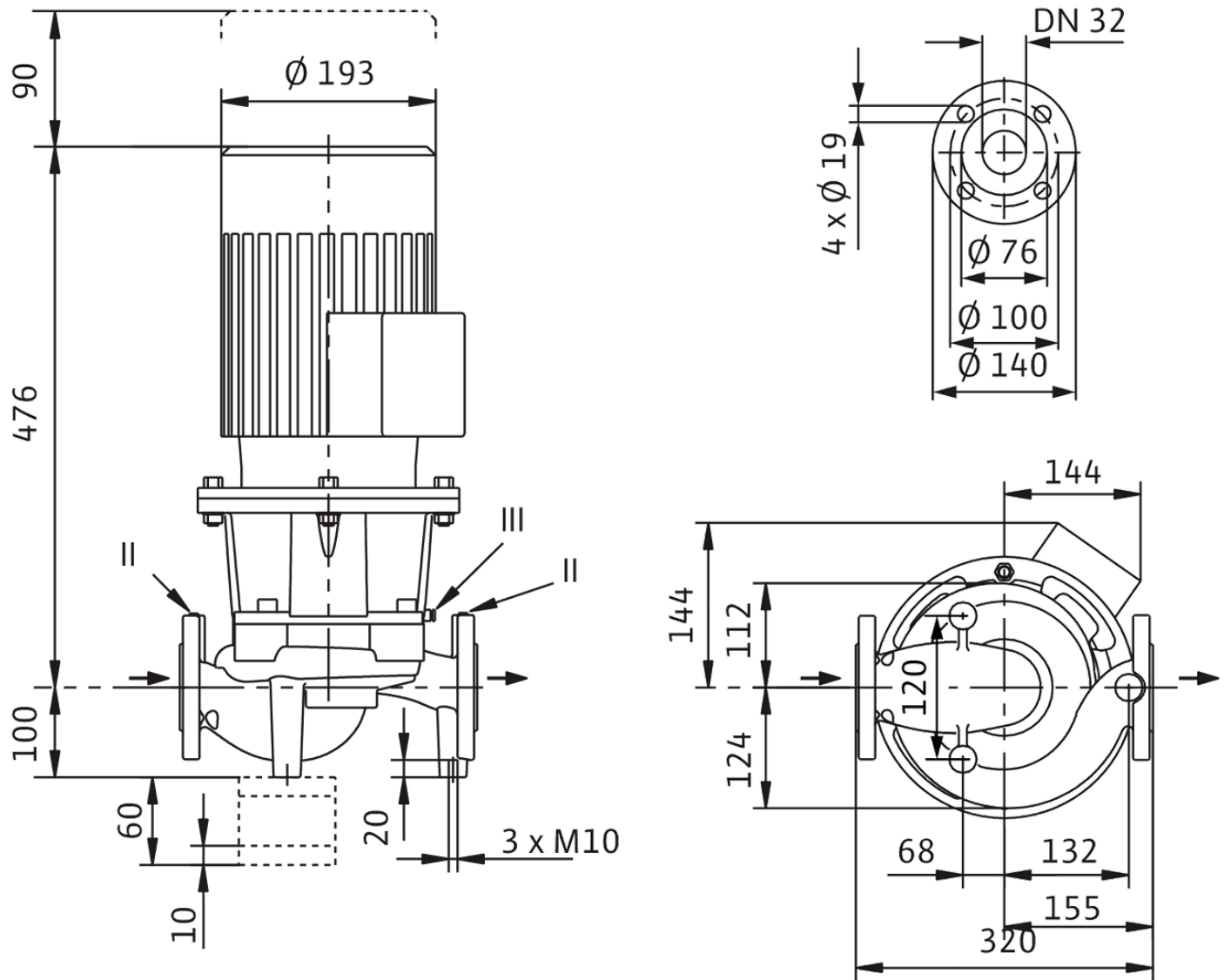

II Pressure measuring connection $R^{1/8}$; III Ventilation $R^{1/8}$

CronoLine-IL 32/160-2,2/2

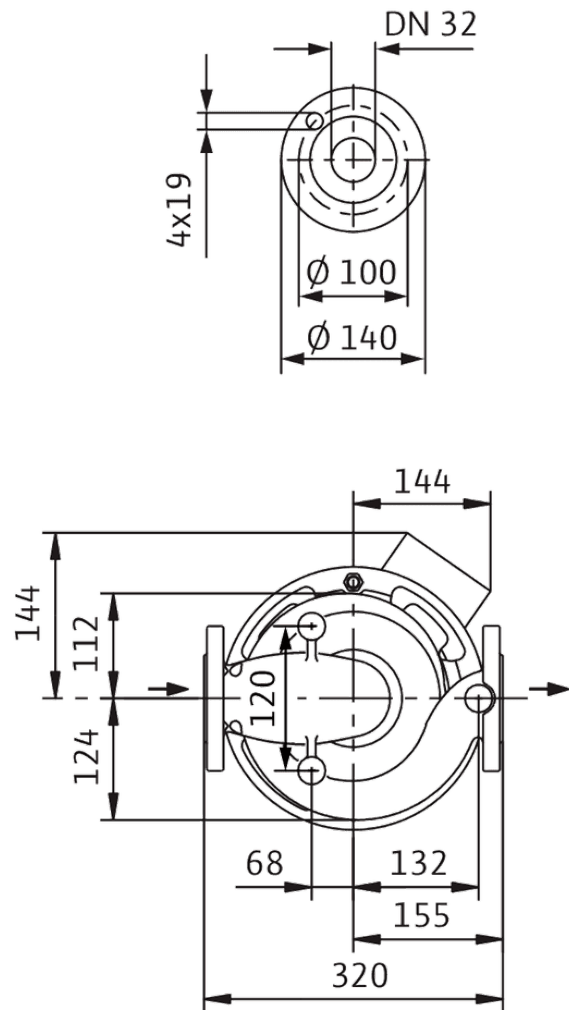
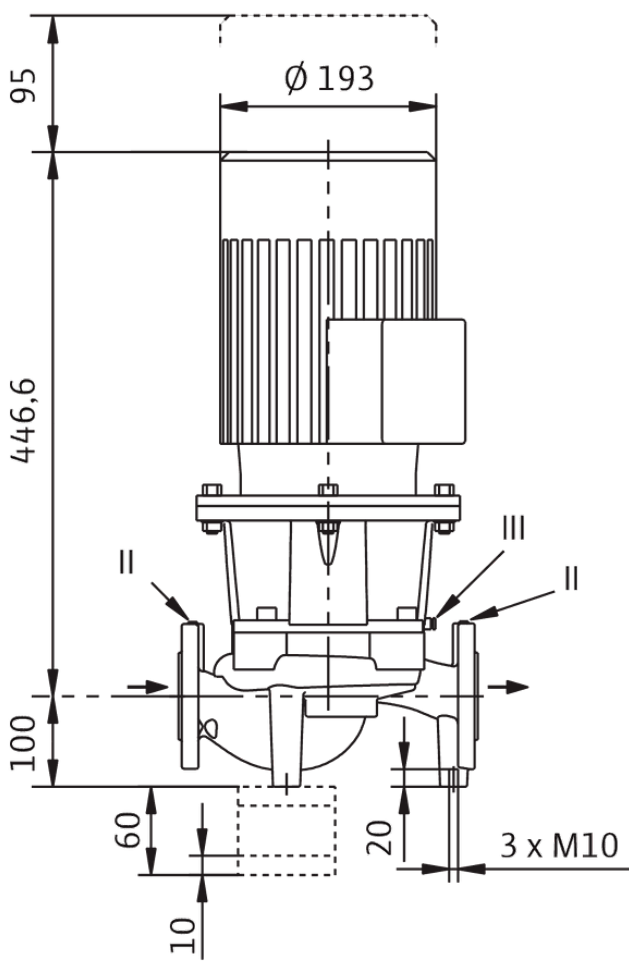

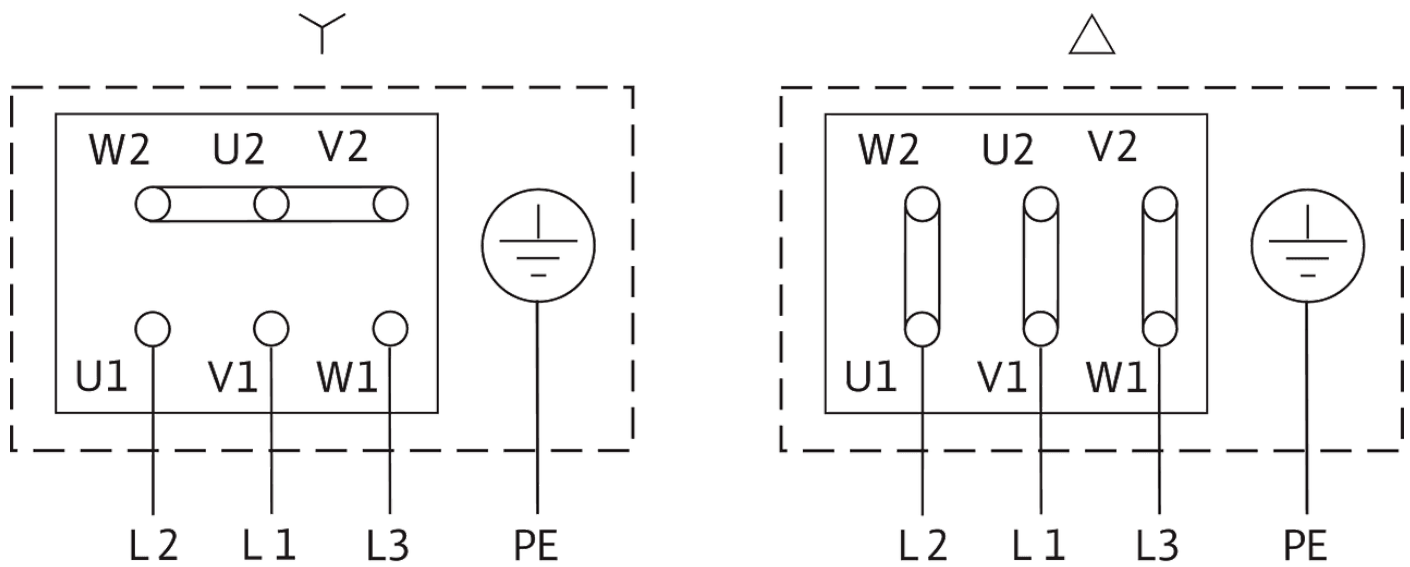

Δ: Connection diagram delta connection

Y: Connection diagram star connection

Motor protection switch required on-site. Check the direction of rotation! To change the direction of rotation, exchange any two phases.

$P_2 \leq 3 \text{ kW}$ 3~400 V Y

3~230 V Δ

$P_2 \geq 4 \text{ kW}$ 3~690 V Y

3~400 V Δ

After removing the bridges, Y-Δ start is possible.

Product data

Brand	Wilo
Product description	CronoLine-IL 32/160-2,2/2
Article number	2120864
EAN number	4048482217161
Colour	Green
Minimum order quantity	1
Date of sales availability	2015-09-01

Dimension, weight

Length with packaging	795 mm
Length <i>L</i>	561 mm
Height with packaging	465 mm
Height <i>H</i>	320 mm
Width with packaging	395 mm
Width <i>W</i>	269 mm
Gross weight, approx. <i>m</i>	60.2 kg
Net weight, approx. <i>m</i>	56 kg

Packaging

Number per layer	1
Packaging property	Transport packaging
Packaging type	Cardboard box
Pieces per pallet	1

Single-stage glanded centrifugal pump with in-line design for pipe installation or installation on a base. Low-vibration and low-noise monobloc design with lantern and rigidly connected standard flange motor. With forced-flow circulation, bidirectional bellows mechanical seal and cavitation-reducing impeller. Flange with R 1/8 pressure measuring connections.

Pump housing and lantern are cataphoretic-coated.

Motors in IE3 technology as standard. Pump with motor ≥ 5.5 kW ... ≤ 55 kW are equipped as standard with a PTC thermistor sensor for motor protection.

Operating data

Fluid media	Water
Fluid temperature T	-20 °C
Ambient temperature T	-15 °C
Maximum operating pressure P_N	16 bar
Note on dimensioning	16 bar to 120°C, 13 bar to 140°C
Minimum efficiency index (MEI)	0.4

Motor data

Motor efficiency class	IE3
Mains connection	3~400 V, 50 Hz
Voltage tolerance	± 10 %
Rated power P_2	2200.0 W
Rated speed n	2900 1/min
Rated current I_N	4.50 A
Power factor $\cos \varphi$	0.81
Motor efficiency η_M 50%	84.3 Percentage
Motor efficiency η_M 75%	85.5 Percentage
Motor efficiency η_M 100%	85.9 Percentage
Insulation class	F
Protection class	IP55

Materials

Pump housing	5.1301/EN-GJL-250 KTL-coated
Impeller	Cast iron
Shaft	Stainless steel
Shaft seal	AQ1EGG
Lantern	5.1301/EN-GJL-250 KTL-coated

Installation dimensions

Pipe connection on the suction side DN_s	DN 32
Pipe connection on the pressure side DN_d	DN 32

Information for order placements

Brand	Wilo
-------	------

Information for order placements

Product description	CronoLine-IL 32/160-2,2/2
Net weight, approx. <i>m</i>	56 kg
Article number	2120864