

**Qty. Description**

1 SP 215-6



Note! Product picture may differ from actual product

Product No.: [18A04306](#)

Submersible borehole pump, suitable for pumping clean water. Can be installed vertically or horizontally. All steel components are made in stainless steel, EN 1.4301 (AISI 304), that ensures high corrosive resistance. This pump carries drinking water approval.

The pump is fitted with a 110 kW MMS8000 motor with sand shield, water-lubricated journal bearings and a volume compensating diaphragm. The rewindable motor construction allows complete access to the windings for easy rewinding. The stator windings are PE/PA insulated made for continuous operations (S1). Suitable for temperatures up to 50 °C. The motor is fitted with a mechanical shaft seal.

The motor is not fitted with a temperature sensor. If temperature monitoring is desired, a Pt100 or Pt1000 sensor can be fitted.

The motor is for direct-on-line starting (DOL).

### Further product details

The pump is suitable for applications similar to the following:

- raw-water supply
- irrigation
- groundwater lowering
- pressure boosting
- fountain applications.

### Pump

All pump surfaces that are in contact with pumped liquids are made in stainless steel which makes them corrosion- and wear-resistant. The corrosion diagram below shows the capabilities of the pump and motor in relation to the temperature in Celsius (y-axis) and the concentration of chloride in ppm (x-axis).

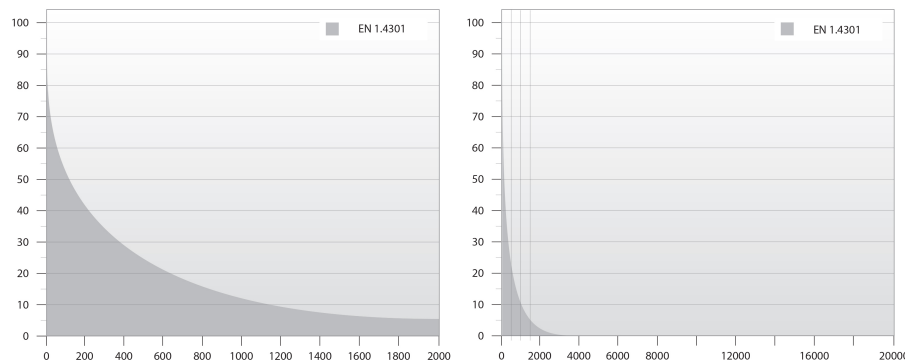

The elastomer parts in the pump are made of NBR (Nitrile-Butadiene Rubber) which ensures good wear resistance and long service intervals.

In case the pump is used for pumping water with high content of hydrocarbons or solvents, Grundfos offers FKM rubber parts (Fluorocarbon) which are oil and temperature-resistant up to 90 °C.

**Qty. Description**

The pump is built with octagonal bearings with sand flush channels that minimise wear. As wear of the pump is inevitable, the pump design allows for easy replacement of all internal wear parts (bearings, impeller, wear rings and seal rings) to maintain high performance and a long lifetime.

The suction interconnector is fitted with a strainer to prevent large particles from entering the pump. The suction interconnector is designed to comply with NEMA standards for motor mounting/dimensions.

**Motor**

The winding wire is made from pure electrolytic copper insulated by extruded two layers of PE/PA with high dielectric strength properties allowing direct contact between the motor fluid and winding wire. This ensures the best possible cooling of the winding wire. The PA layer ensures high mechanical wear properties of the winding wire.

The shaft seal faces are SiC/SiC. The material combination gives good performance when abrasive particles (sand) is present. Together with the shaft seal housing, the sand shield forms a labyrinth seal, which during normal operating conditions prevents penetration of sand particles into the shaft seal. This shaft seal is drinking water approved.

The motor can be fitted with a Pt100 or Pt1000 sensor that together with a control unit ensures that the maximum operating temperature conditions are not exceeded.

**Liquid:**

Pumped liquid: Water  
 Maximum liquid temperature: 40 °C  
 Max liquid t at 0.15 m/sec: 35 °C  
 Max liquid t at 0.5 m/sec: 40 °C  
 Selected liquid temperature: 20 °C  
 Density: 998.2 kg/m<sup>3</sup>

**Technical:**

Pump speed on which pump data are based: 2900 rpm  
 Rated flow: 215 m<sup>3</sup>/h  
 Rated head: 149 m  
 Shaft seal for motor: SIC/SIC  
 Curve tolerance: ISO9906:2012 3B  
 Motor version: T40

**Materials:**

Pump: Stainless steel  
 EN 1.4301  
 AISI AISI 304  
 Impeller: Stainless steel  
 EN 1.4301  
 AISI AISI 304  
 Motor: Cast iron  
 DIN W.-Nr. 0.6025  
 ASTM 35-40

**Installation:**

Pump outlet: RP6  
 Motor diameter: 8 inch

**Electrical data:**

Motor type: MMS8000  
 Rated power - P2: 110 kW  
 Power (P2) required by pump: 110 kW  
 Mains frequency: 50 Hz  
 Rated voltage: 3 x 380-400-415 V  
 Rated current: 230-224-222 A  
 Starting current: 520-580-600 %  
 Cos phi - power factor: 0.89-0.87-0.84  
 Rated speed: 2870-2890-2900 rpm  
 Start. method: direct-on-line



Company name:

Created by:

Phone:

Date:

10/11/2020

Qty.	Description
	<p>Enclosure class (IEC 34-5): IP68 Built-in temp. transmitter: no Motor No: 96511375 Windings: PE2/PA</p> <p>Others: Minimum efficiency index, MEI <math>\hat{\alpha}\%_{\text{m}}</math>: --- ErP status: EuP Standalone/Prod. Net weight: 426 kg Gross weight: 492 kg Shipping volume: 0.584 m<sup>3</sup> Country of origin: GB Custom tariff no.: 84137029</p>

## 18A04306 SP 215-6 50 Hz

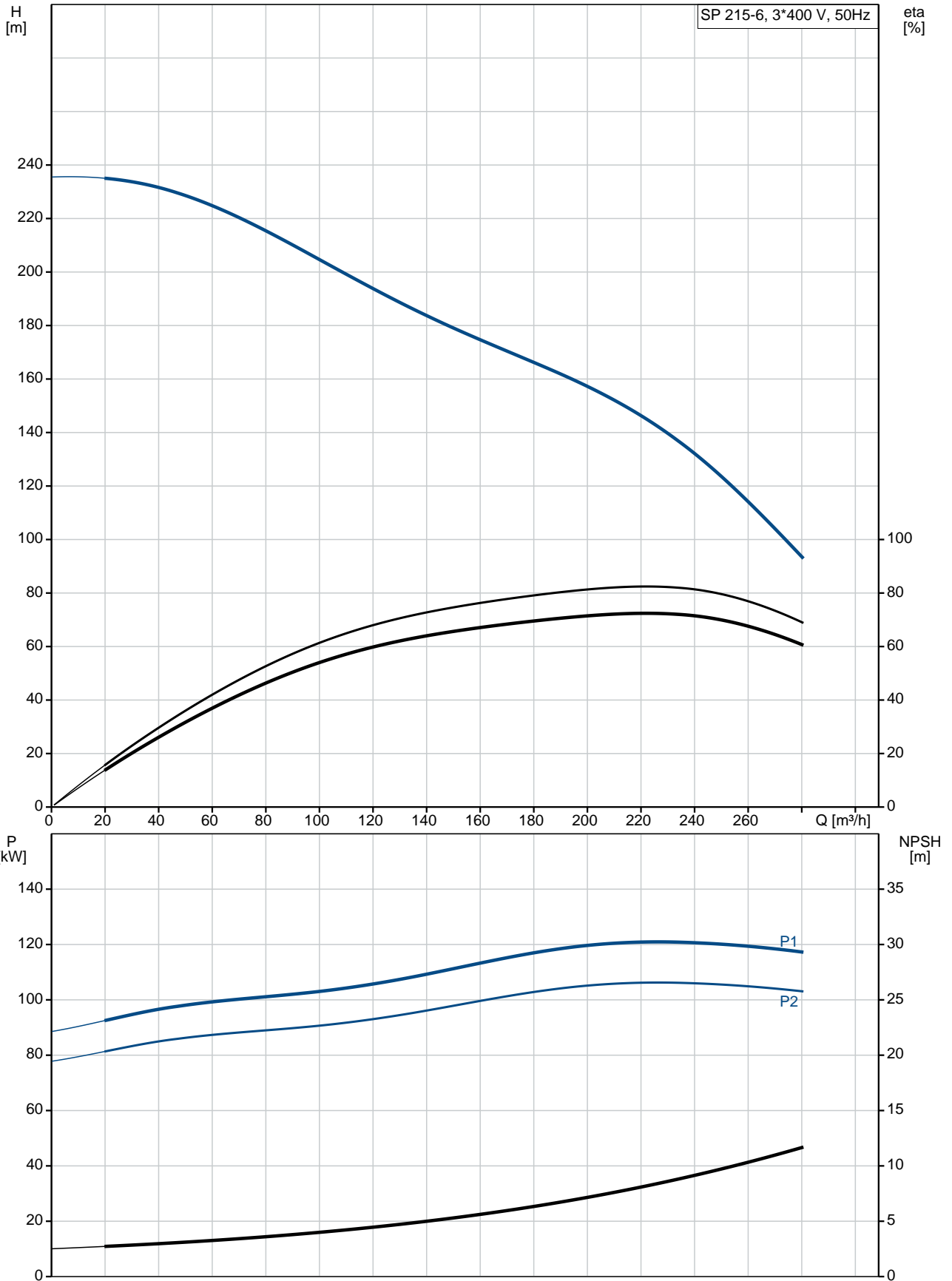

Description	Value
<b>General information:</b>	
Product name:	SP 215-6
Product No:	18A04306
EAN number:	5700831507611
<b>Technical:</b>	
Pump speed on which pump data are based:	2900 rpm
Rated flow:	215 m <sup>3</sup> /h
Rated head:	149 m
Stages:	6
Impeller reduc.:	NONE
Shaft seal for motor:	SIC/SIC
Curve tolerance:	ISO9906:2012 3B
Model:	C
Valve:	YES
Motor version:	T40
<b>Materials:</b>	
Pump:	Stainless steel
Pump:	EN 1.4301
Pump:	AISI AISI 304
Impeller:	Stainless steel
Impeller:	EN 1.4301
Impeller:	AISI AISI 304
Motor:	Cast iron
Motor:	DIN W.-Nr. 0.6025
Motor:	ASTM 35-40
<b>Installation:</b>	
Pump outlet:	RP6
Motor diameter:	8 inch
<b>Liquid:</b>	
Pumped liquid:	Water
Maximum liquid temperature:	40 °C
Max liquid t at 0.15 m/sec:	35 °C
Max liquid t at 0.5 m/sec:	40 °C
Selected liquid temperature:	20 °C
Density:	998.2 kg/m <sup>3</sup>
<b>Electrical data:</b>	
Motor type:	MMS8000
Applic. motor:	GRUNDFOS
Rated power - P2:	110 kW
Power (P2) required by pump:	110 kW
Mains frequency:	50 Hz
Rated voltage:	3 x 380-400-415 V
Rated current:	230-224-222 A
Starting current:	520-580-600 %
Cos phi - power factor:	0.89-0.87-0.84
Rated speed:	2870-2890-2900 rpm
Start. method:	direct-on-line
Enclosure class (IEC 34-5):	IP68
Motor protec:	NONE
Thermal protec:	external
Built-in temp. transmitter:	no
Motor No:	96511375
Windings:	PE2/PA
<b>Others:</b>	
Minimum efficiency index, MEI $\hat{\alpha}\%$ :	---
ErP status:	EuP Standalone/Prod.
Net weight:	426 kg

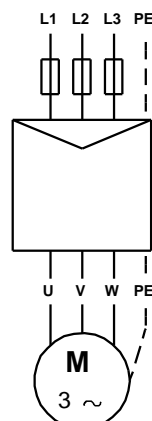
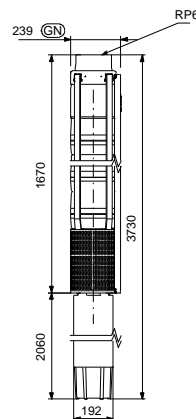
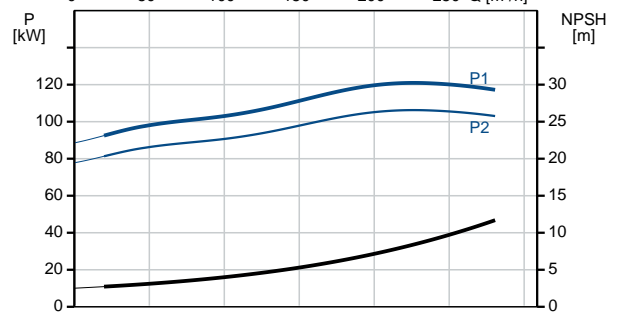
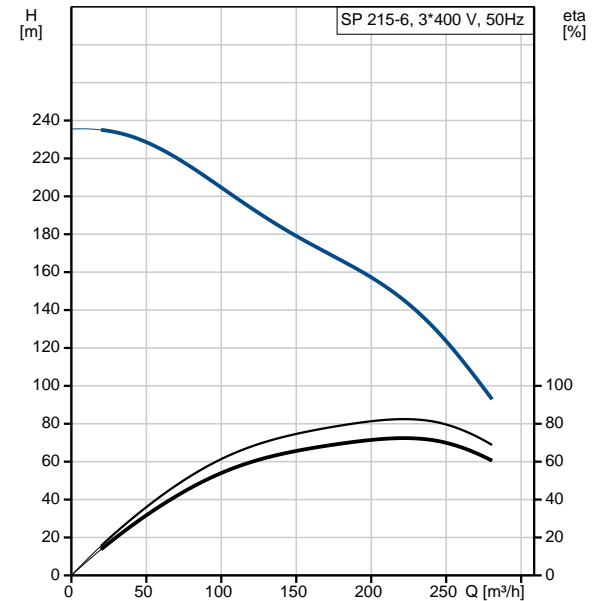



**Company name:**

**Created by:**

**Phone:**

**Date:**

10/11/2020

Description	Value
Gross weight:	492 kg
Shipping volume:	0.584 m <sup>3</sup>
Country of origin:	GB
Custom tariff no.:	84137029

## 18A04306 SP 215-6 50 Hz

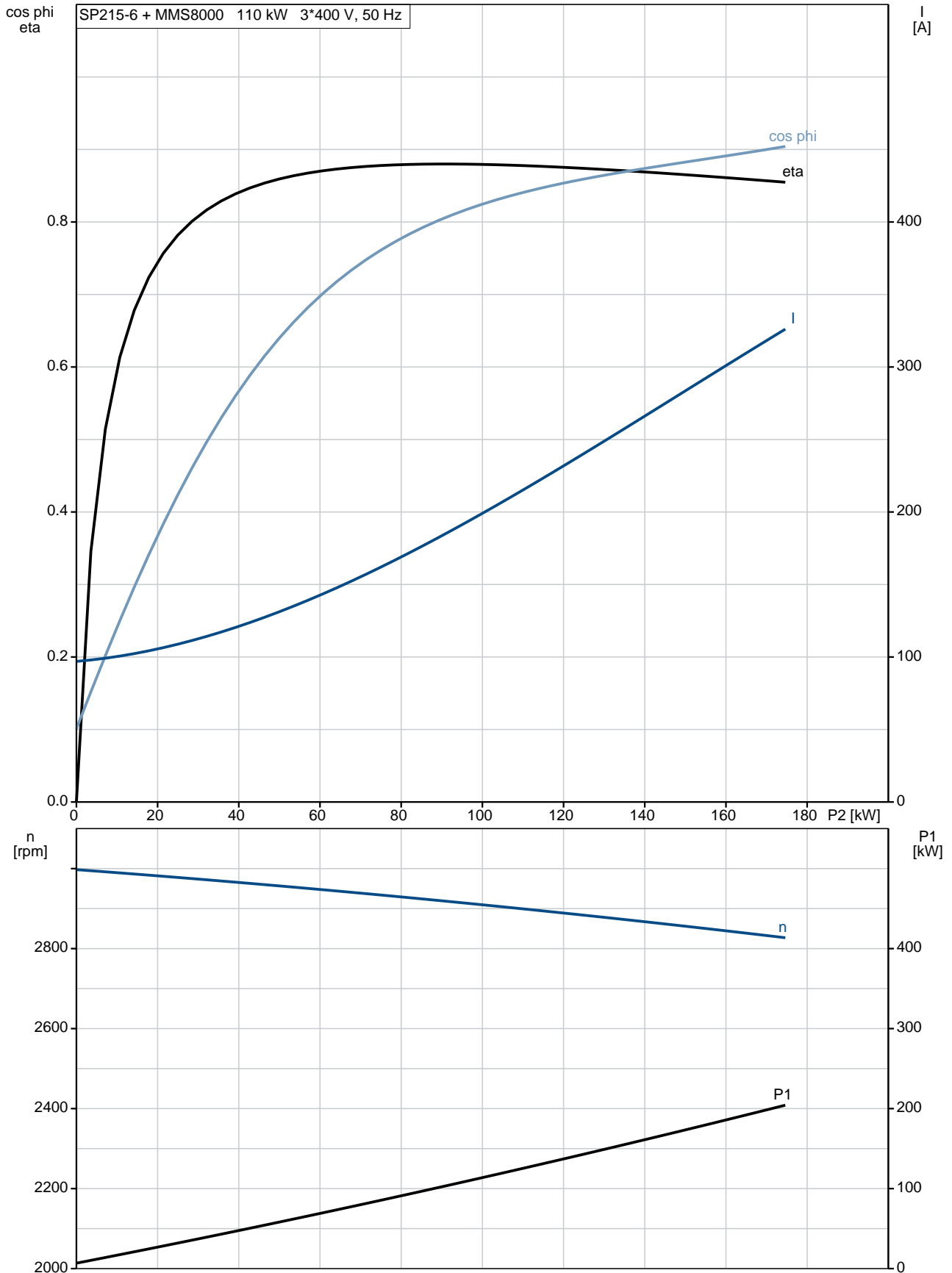

## 18A04306 SP 215-6 50 Hz

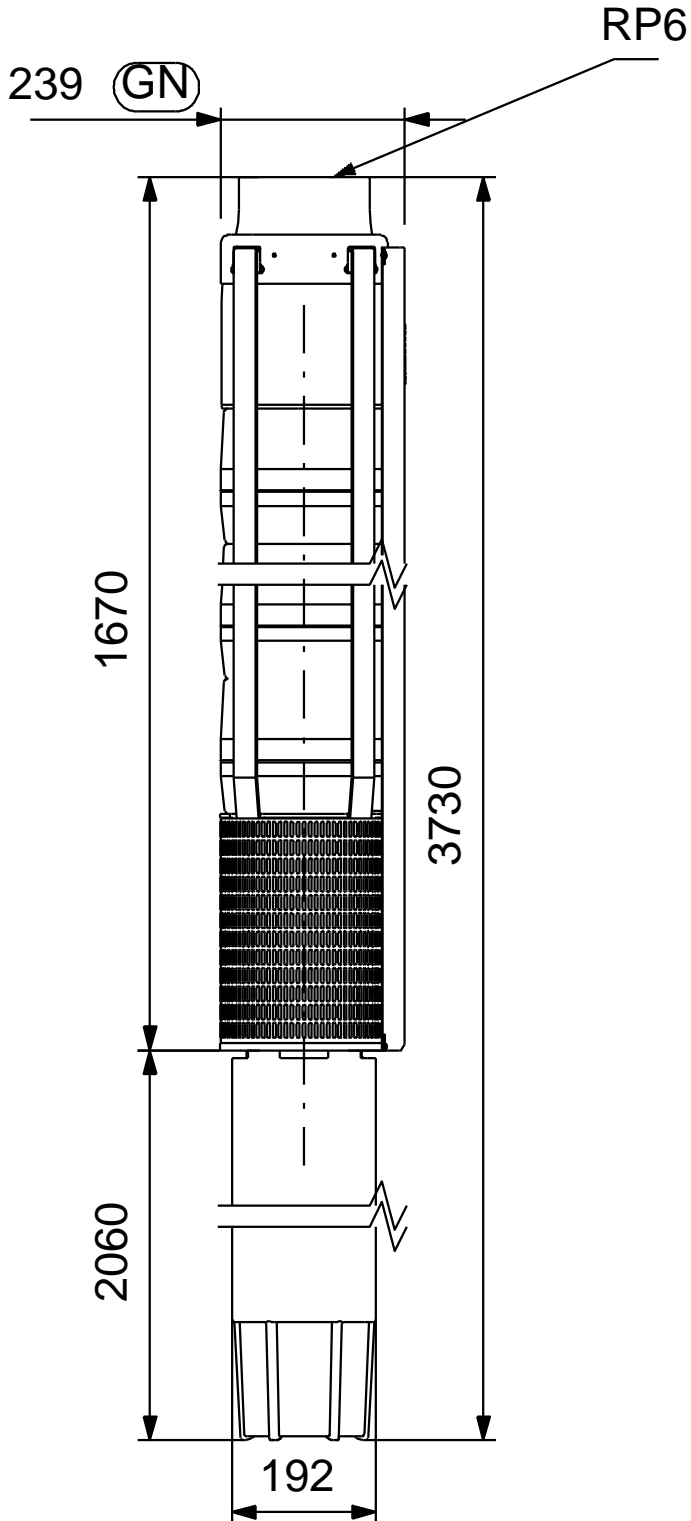

Note! All units are in [mm] unless others are stated.  
Disclaimer: This simplified dimensional drawing does not show all details.



**18A04306 SP 215-6 50 Hz**



Note! All units are in [mm] unless others are stated.