

Qty. Description

1 SP 30-3



Note! Product picture may differ from actual product

Product No.: [13A01903](#)

Submersible borehole pump, suitable for pumping clean water. Can be installed vertically or horizontally. All steel components are made in stainless steel, EN 1.4301 (AISI 304), that ensures high corrosive resistance. This pump carries drinking water approval.

The pump is fitted with a 3 kW MS4000 motor with sand shield, mechanical shaft seal, water-lubricated journal bearings and a volume compensating diaphragm. The motor is a canned type submersible motor offering good mechanical stability and high efficiency. Suitable for temperatures up to 40 °C.

The motor is not fitted with a temperature sensor. If temperature monitoring is desired, a Pt1000 sensor can be fitted.

The motor is for direct-on-line starting (DOL).

Further product details

The pump is suitable for applications similar to the following:

- raw-water supply
- irrigation
- groundwater lowering
- pressure boosting
- fountain applications.

The Grundfos SP pump is renowned for its high efficiency and already complies with the requirements of the Minimum Efficiency Index, and therefore Grundfos is amongst the best in class within submersible pumps.



Pump

All pump surfaces that are in contact with pumped liquids are made in stainless steel which makes them corrosion- and wear-resistant. The corrosion diagram below shows the capabilities of the pump and motor in relation to the temperature in Celsius (y-axis) and the concentration of chloride in ppm (x-axis).

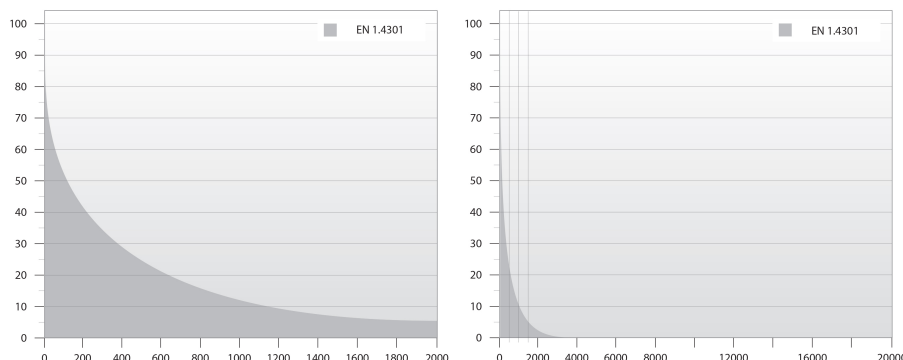

Qty. Description

The elastomer parts in the pump are made of NBR (Nitrile-Butadiene Rubber) which ensures good wear resistance and long service intervals.

In case the pump is used for pumping water with high content of hydrocarbons or solvents, Grundfos offers FKM rubber parts (Fluorocarbon) which are oil and temperature-resistant up to 90 °C.

The pump is built with octagonal bearings with sand flush channels that minimise wear. As wear of the pump is inevitable, the pump design allows for easy replacement of all internal wear parts (bearings, impeller, wear rings and seal rings) to maintain high performance and a long lifetime.

The suction interconnector is fitted with a strainer to prevent large particles from entering the pump. The suction interconnector is designed to comply with NEMA standards for motor mounting/dimensions.

Motor

The stator is hermetically encapsulated in stainless steel and the windings are embedded in polymer compound. This results in high mechanical stability, optimum cooling and reduces the risk of short circuits in the windings.

The shaft seal is a tungsten carbide/ceramic replaceable mechanical shaft seal. The material combination provides optimum sealing, resistance and long life. Together with the shaft seal housing, the sand shield forms a labyrinth seal, which during normal operating conditions prevents penetration of sand particles into the shaft seal.

The motor can be fitted with a Pt100 or Pt1000 sensor that together with a control unit ensures that the maximum operating temperature conditions are not exceeded.

Liquid:

Pumped liquid:	Water
Maximum liquid temperature:	40 °C
Max liquid t at 0.15 m/sec:	40 °C
Selected liquid temperature:	20 °C
Density:	998.2 kg/m ³

Technical:

Pump speed on which pump data are based:	2900 rpm
Rated flow:	30 m ³ /h
Rated head:	22 m
Shaft seal for motor:	HM/CER
Approvals on nameplate:	CE,EAC
Curve tolerance:	ISO9906:2012 3B
Motor version:	T40

Materials:

Pump:	Stainless steel EN 1.4301 AISI AISI 304
Impeller:	Stainless steel EN 1.4301 AISI AISI 304
Motor:	Stainless steel DIN W.-Nr. 1.4301 AISI 304

Installation:

Pump outlet:	RP3
Motor diameter:	4 inch

Electrical data:

Motor type:	MS4000
Rated power - P2:	3 kW
Power (P2) required by pump:	3 kW
Mains frequency:	50 Hz
Rated voltage:	3 x 380-400-415 V
Rated current:	7.70-7.85-8.10 A
Starting current:	460-490-500 %
Cos phi - power factor:	0.82-0.77-0.73



Company name:

Created by:

Phone:

Date:

10/11/2020

Qty.	Description
	<p>Rated speed: 2850-2865-2875 rpm Start. method: direct-on-line Enclosure class (IEC 34-5): IP68 Insulation class (IEC 85): F Built-in temp. transmitter: no Motor No: 79194508</p> <p>Others: Minimum efficiency index, MEI $\eta_{\%}$: 0.50 ErP status: EuP Standalone/Prod. Net weight: 28 kg Gross weight: 32.4 kg Shipping volume: 0.052 m³ Danish VVS No.: 388338030 Finnish LVI No.: 4762732 Country of origin: DK Custom tariff no.: 84137029</p>

13A01903 SP 30-3 50 Hz

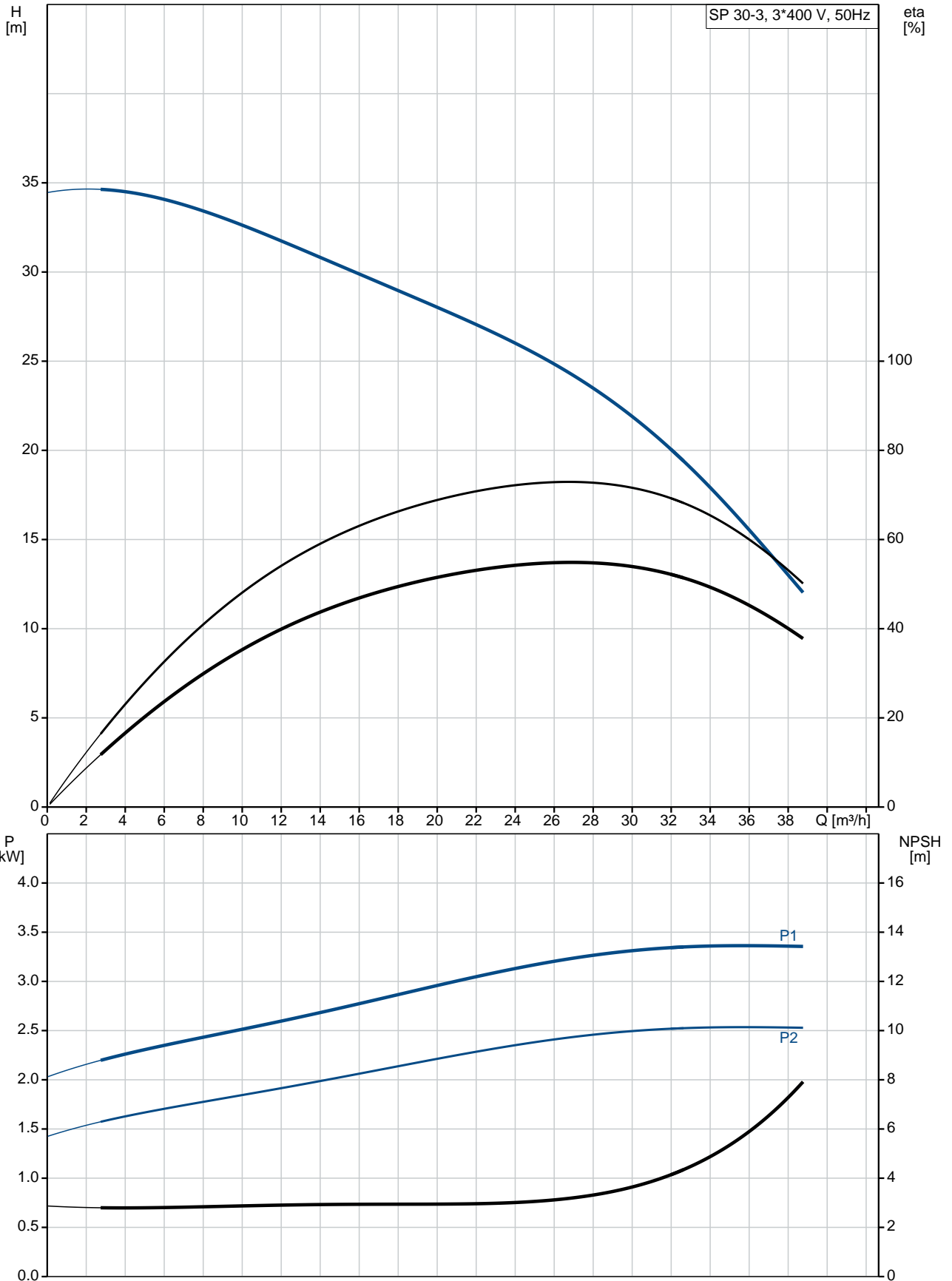

Description	Value
General information:	
Product name:	SP 30-3
Product No:	13A01903
EAN number:	5700391137709
Price:	GBP 1943
Technical:	
Pump speed on which pump data are based:	2900 rpm
Rated flow:	30 m ³ /h
Rated head:	22 m
Stages:	3
Impeller reduc.:	NONE
Shaft seal for motor:	HM/CER
Approvals on nameplate:	CE,EAC
Curve tolerance:	ISO9906:2012 3B
Model:	B
Valve:	YES
Motor version:	T40
Materials:	
Pump:	Stainless steel
Pump:	EN 1.4301
Pump:	AISI AISI 304
Impeller:	Stainless steel
Impeller:	EN 1.4301
Impeller:	AISI AISI 304
Motor:	Stainless steel
Motor:	DIN W.-Nr. 1.4301
Motor:	AISI 304
Installation:	
Pump outlet:	RP3
Motor diameter:	4 inch
Liquid:	
Pumped liquid:	Water
Maximum liquid temperature:	40 °C
Max liquid t at 0.15 m/sec:	40 °C
Selected liquid temperature:	20 °C
Density:	998.2 kg/m ³
Electrical data:	
Motor type:	MS4000
Applic. motor:	GRUNDFOS
Rated power - P2:	3 kW
Power (P2) required by pump:	3 kW
Mains frequency:	50 Hz
Rated voltage:	3 x 380-400-415 V
Rated current:	7.70-7.85-8.10 A
Starting current:	460-490-500 %
Cos phi - power factor:	0.82-0.77-0.73
Rated speed:	2850-2865-2875 rpm
Start. method:	direct-on-line
Enclosure class (IEC 34-5):	IP68
Insulation class (IEC 85):	F
Motor protec:	NONE
Thermal protec:	external
Built-in temp. transmitter:	no
Motor No:	79194508
Others:	
Minimum efficiency index, MEI %:	0.50
ErP status:	EuP Standalone/Prod.

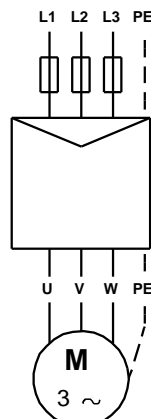
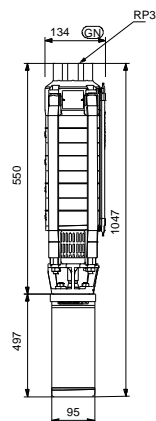
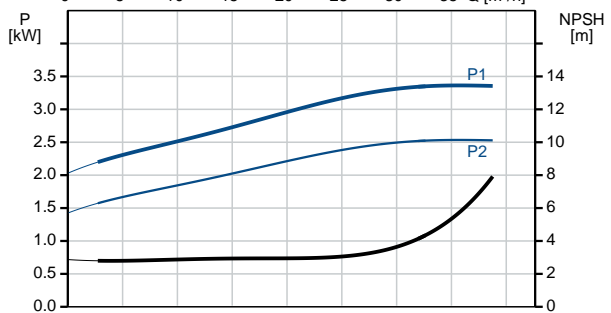
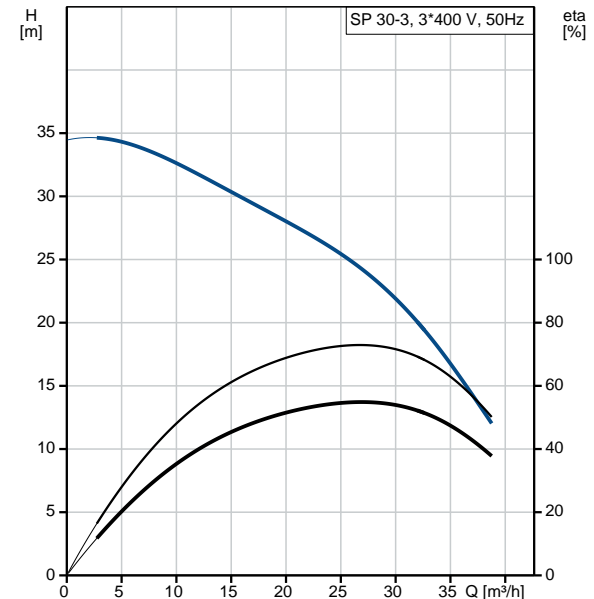



Company name:

Created by:

Phone:

Date:

10/11/2020

Description	Value
Net weight:	28 kg
Gross weight:	32.4 kg
Shipping volume:	0.052 m ³
Danish VVS No.:	388338030
Finnish LVI No.:	4762732
Country of origin:	DK
Custom tariff no.:	84137029

13A01903 SP 30-3 50 Hz

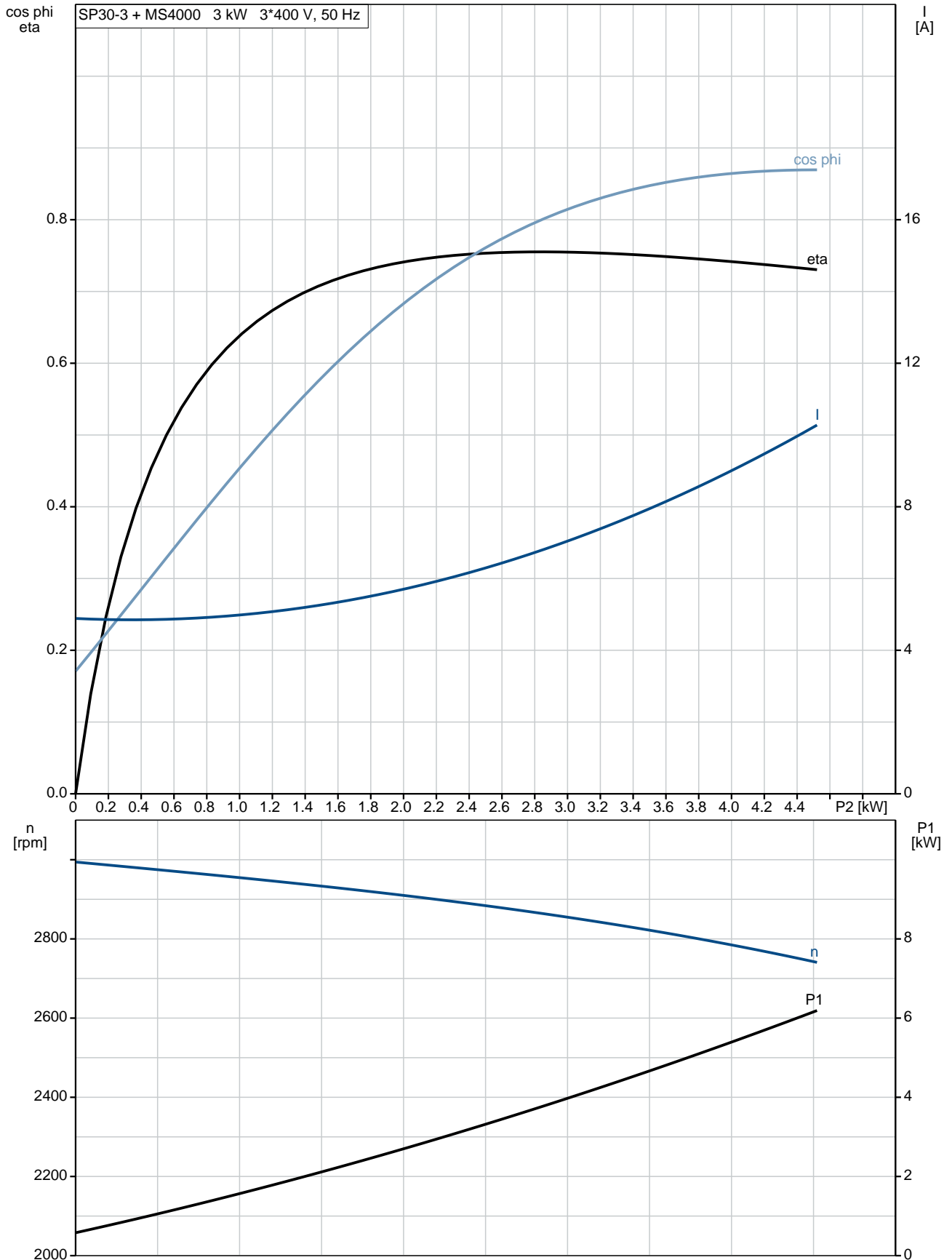

13A01903 SP 30-3 50 Hz

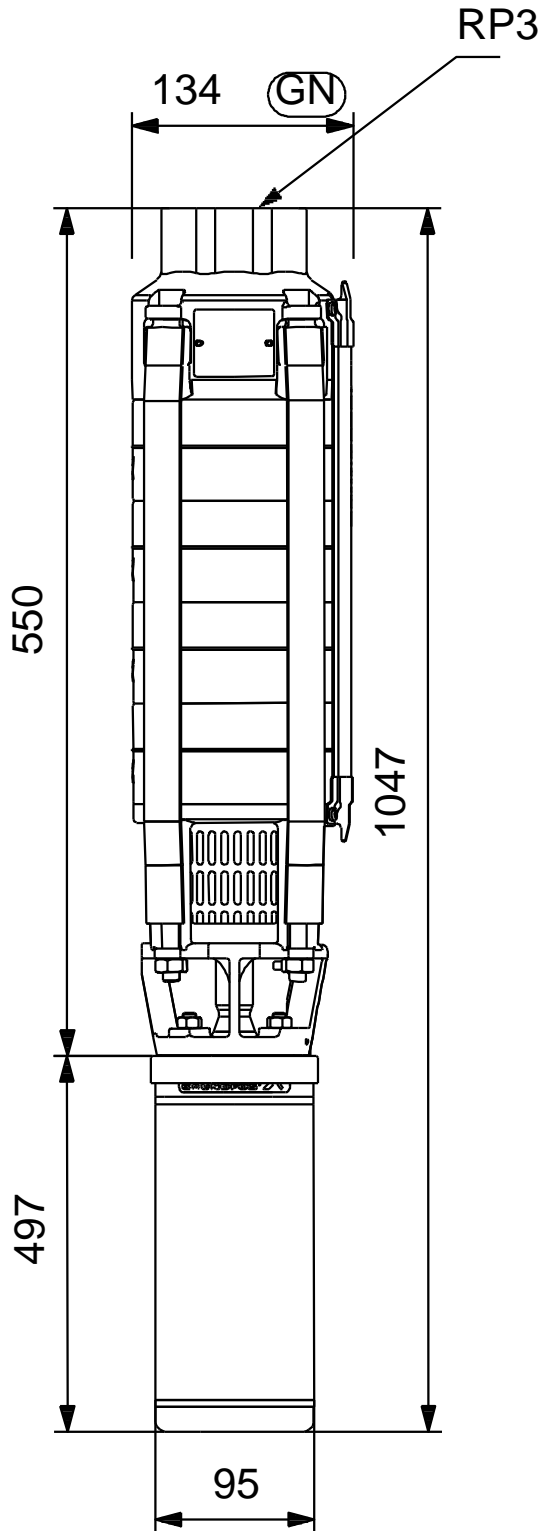

Note! All units are in [mm] unless others are stated.
Disclaimer: This simplified dimensional drawing does not show all details.

13A01903 SP 30-3 50 Hz

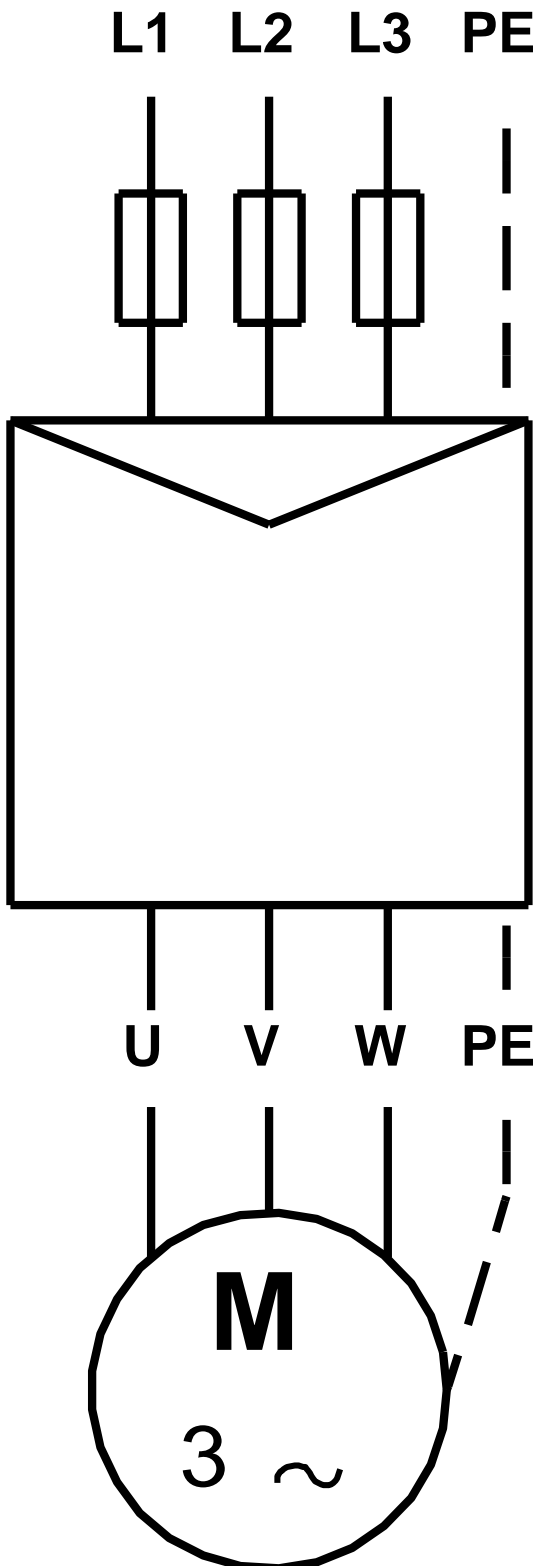

Note! All units are in [mm] unless others are stated.