

Qty.	Description
------	-------------

1	SP 17-36
---	----------



Note! Product picture may differ from actual product

Product No.: [12A01936](#)

Submersible borehole pump, suitable for pumping clean water. Can be installed vertically or horizontally. All steel components are made in stainless steel, EN 1.4301 (AISI 304), that ensures high corrosive resistance. This pump carries drinking water approval.

The pump is fitted with a 22 kW MS6000 motor with sand shield, mechanical shaft seal, water-lubricated journal bearings and a volume compensating diaphragm. The motor is a canned type submersible motor offering good mechanical stability and high efficiency. Suitable for temperatures up to 40 °C.

The motor is fitted with the Grundfos Tempcon sensor that, by use of powerline communication together with a MP204 control panel, enables temperature monitoring.

The motor is for direct-on-line starting (DOL).

### Further product details

The pump is suitable for applications similar to the following:

- raw-water supply
- irrigation
- groundwater lowering
- pressure boosting
- fountain applications.

The Grundfos SP pump is renowned for its high efficiency and already complies with the requirements of the Minimum Efficiency Index, and therefore Grundfos is amongst the best in class within submersible pumps.



### Pump

All pump surfaces that are in contact with pumped liquids are made in stainless steel which makes them corrosion- and wear-resistant. The corrosion diagram below shows the capabilities of the pump and motor in relation to the temperature in Celsius (y-axis) and the concentration of chloride in ppm (x-axis).



The elastomer parts in the pump are made of NBR (Nitrile-Butadiene Rubber) which ensures good wear resistance and long service intervals.

In case the pump is used for pumping water with high content of hydrocarbons or solvents, Grundfos offers FKM rubber parts (Fluorocarbon) which are oil and temperature-resistant up to 90 °C.

The pump is built with octagonal bearings with sand flush channels that minimise wear. As wear of the pump is inevitable, the pump design allows for easy replacement of all internal wear parts (bearings, impeller, wear rings and seal rings) to maintain high performance and a long lifetime.

The suction interconnector is fitted with a strainer to prevent large particles from entering the pump. The suction interconnector is designed to comply with NEMA standards for motor mounting/dimensions.

## Motor

The stator is hermetically encapsulated in stainless steel and the windings are embedded in polymer compound. This results in high mechanical stability, optimum cooling and reduces the risk of short circuits in the windings.

The shaft seal faces are ceramic/carbon. The material combination provides good dry-running resistance. Together with the shaft seal housing, the sand shield forms a labyrinth seal, which during normal operating conditions prevents penetration of sand particles into the shaft seal.

The motor is fitted with the Grundfos Tempcon temperature sensor device that includes a NTC-resistor which senses the temperature. The resistor is built-in close to the winding. The temperature is converted into a high-frequency signal which is sent via the submersible drop cable and which can be converted into a temperature reading by means of Grundfos MP204.

The MP204 is an electronic motor protection device that also monitors the supply network quality to protect the submersible motor against supply network disturbances.



### Liquid:

Pumped liquid:	Water
Maximum liquid temperature:	40 °C
Max liquid t at 0.15 m/sec:	40 °C
Selected liquid temperature:	20 °C
Density:	998.2 kg/m <sup>3</sup>

### Technical:

Pump speed on which pump data are based:	2900 rpm
Rated flow:	17 m <sup>3</sup> /h
Rated head:	296 m
Shaft seal for motor:	CER/CARNBR
Approvals on nameplate:	CE, GOST2

Qty.	Description
	Curve tolerance: ISO9906:2012 3B Motor version: T40  Materials: Pump: Stainless steel EN 1.4301 AISI AISI 304 Impeller: Stainless steel EN 1.4301 AISI AISI 304 Motor: Stainless steel DIN W.-Nr. 1.4301 AISI 304  Installation: Pump outlet: RP2 1/2 Motor diameter: 6 inch  Electrical data: Motor type: MS6000 Rated power - P2: 22 kW Power (P2) required by pump: 22 kW Mains frequency: 50 Hz Rated voltage: 3 x 380-400-415 V Rated current: 49.5-47.5-46.5 A Starting current: 480-530-560 % Cos phi - power factor: 0.86-0.84-0.82 Rated speed: 2850-2870-2880 rpm Start. method: direct-on-line Enclosure class (IEC 34-5): IP68 Insulation class (IEC 85): F Built-in temp. transmitter: yes Motor No: 78195518  Others: Minimum efficiency index, MEI $\eta_{\%}$ : 0.70 ErP status: EuP Standalone/Prod. Net weight: 122 kg Gross weight: 167 kg Shipping volume: 0.412 m <sup>3</sup> Danish VVS No.: 388336360 Country of origin: DK Custom tariff no.: 84137029

## 12A01936 SP 17-36 50 Hz

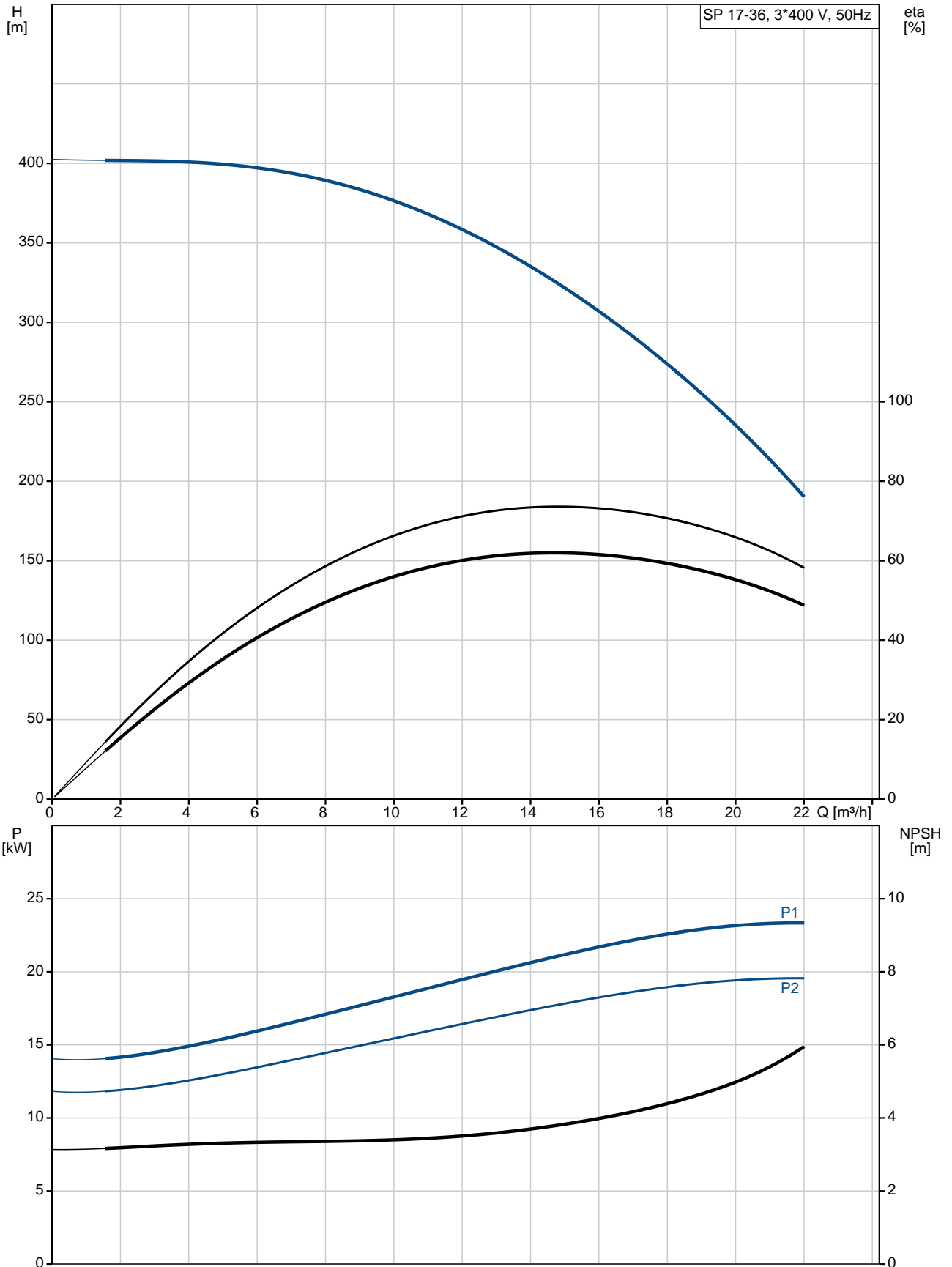

Description	Value
<b>General information:</b>	
Product name:	SP 17-36
Product No:	12A01936
EAN number:	5700391132223
Price:	GBP 8202
<b>Technical:</b>	
Pump speed on which pump data are based:	2900 rpm
Rated flow:	17 m <sup>3</sup> /h
Rated head:	296 m
Stages:	36
Impeller reduc.:	NONE
Shaft seal for motor:	CER/CARNBR
Approvals on nameplate:	CE,GOST2
Curve tolerance:	ISO9906:2012 3B
Model:	B
Valve:	YES
Motor version:	T40
<b>Materials:</b>	
Pump:	Stainless steel
Pump:	EN 1.4301
Pump:	AISI AISI 304
Impeller:	Stainless steel
Impeller:	EN 1.4301
Impeller:	AISI AISI 304
Motor:	Stainless steel
Motor:	DIN W.-Nr. 1.4301
Motor:	AISI 304
<b>Installation:</b>	
Pump outlet:	RP2 1/2
Motor diameter:	6 inch
<b>Liquid:</b>	
Pumped liquid:	Water
Maximum liquid temperature:	40 °C
Max liquid t at 0.15 m/sec:	40 °C
Selected liquid temperature:	20 °C
Density:	998.2 kg/m <sup>3</sup>
<b>Electrical data:</b>	
Motor type:	MS6000
Applic. motor:	GRUNDFOS
Rated power - P2:	22 kW
Power (P2) required by pump:	22 kW
Mains frequency:	50 Hz
Rated voltage:	3 x 380-400-415 V
Rated current:	49.5-47.5-46.5 A
Starting current:	480-530-560 %
Cos phi - power factor:	0.86-0.84-0.82
Rated speed:	2850-2870-2880 rpm
Start. method:	direct-on-line
Enclosure class (IEC 34-5):	IP68
Insulation class (IEC 85):	F
Motor protec:	NONE
Thermal protec:	external
Built-in temp. transmitter:	yes
Motor No:	78195518
<b>Others:</b>	
Minimum efficiency index, MEI $\hat{a}\%$ o¥:	0.70
ErP status:	EuP Standalone/Prod.

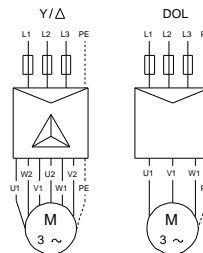
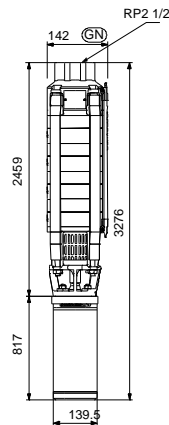
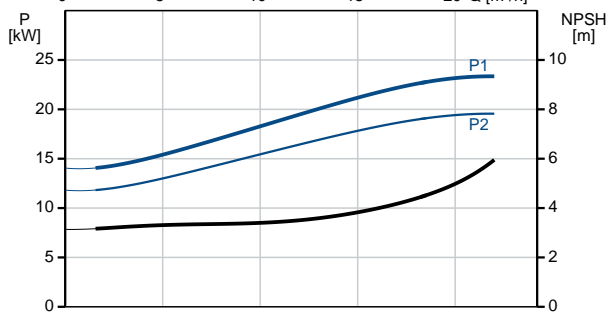
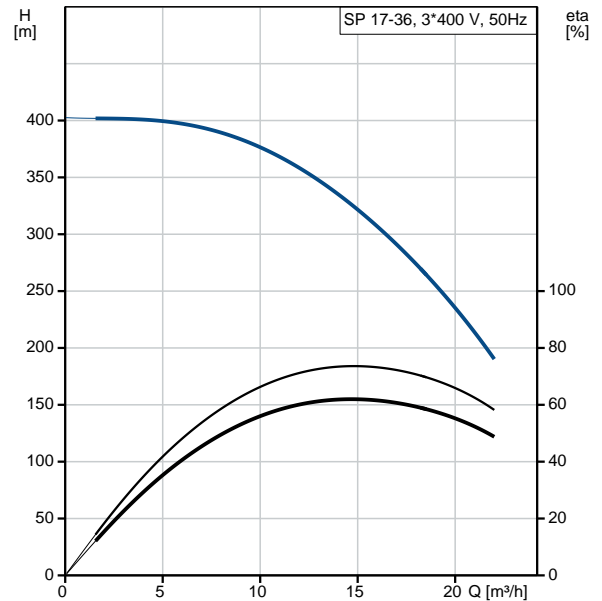

U1, W2	Brown
V1, U2	Black
W1, V2	Grey



Company name:

Created by:

Phone:

Date:

10/11/2020

Description	Value
Net weight:	122 kg
Gross weight:	167 kg
Shipping volume:	0.412 m <sup>3</sup>
Danish VVS No.:	388336360
Country of origin:	DK
Custom tariff no.:	84137029

## 12A01936 SP 17-36 50 Hz

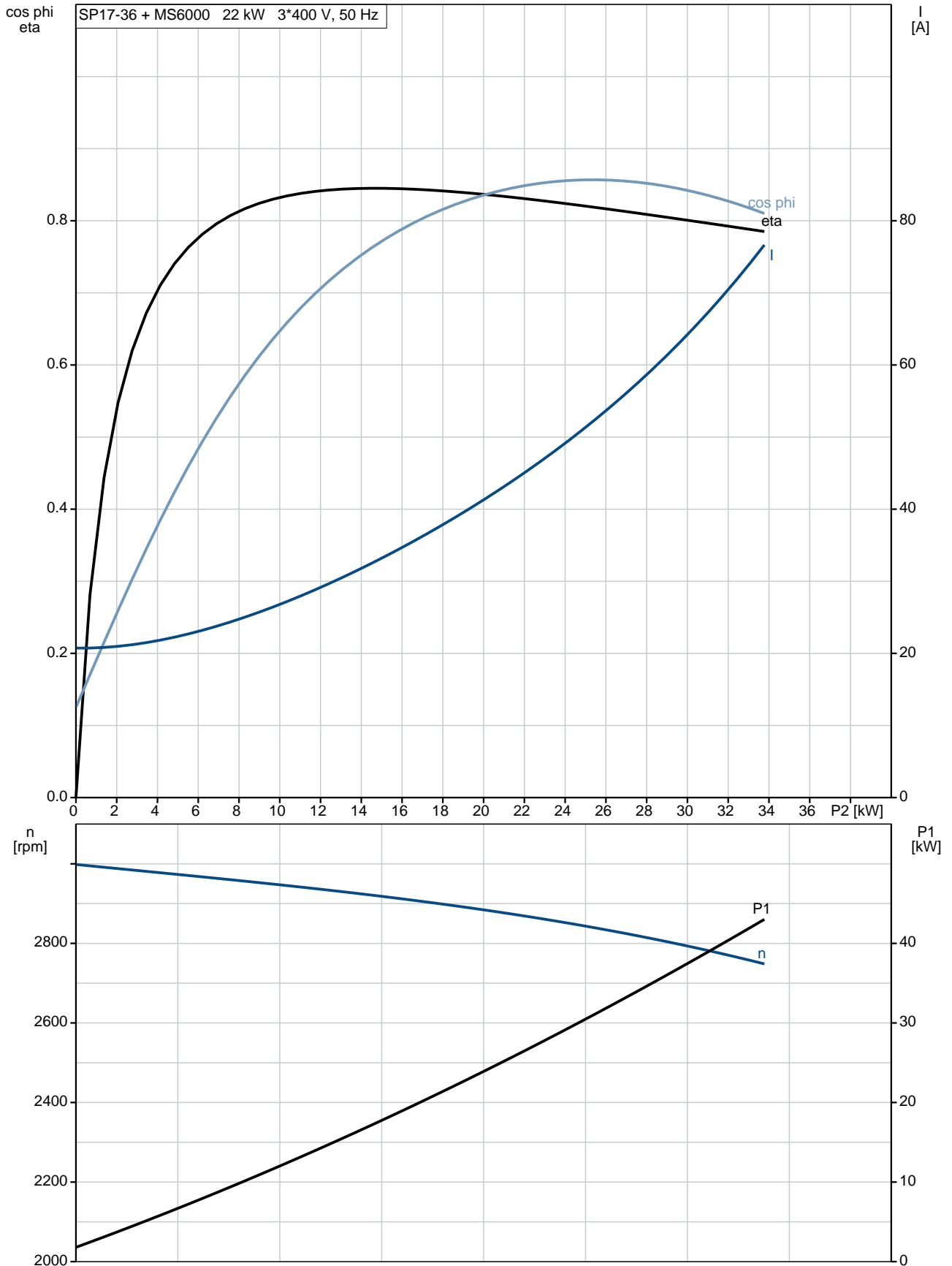

**12A01936 SP 17-36 50 Hz**

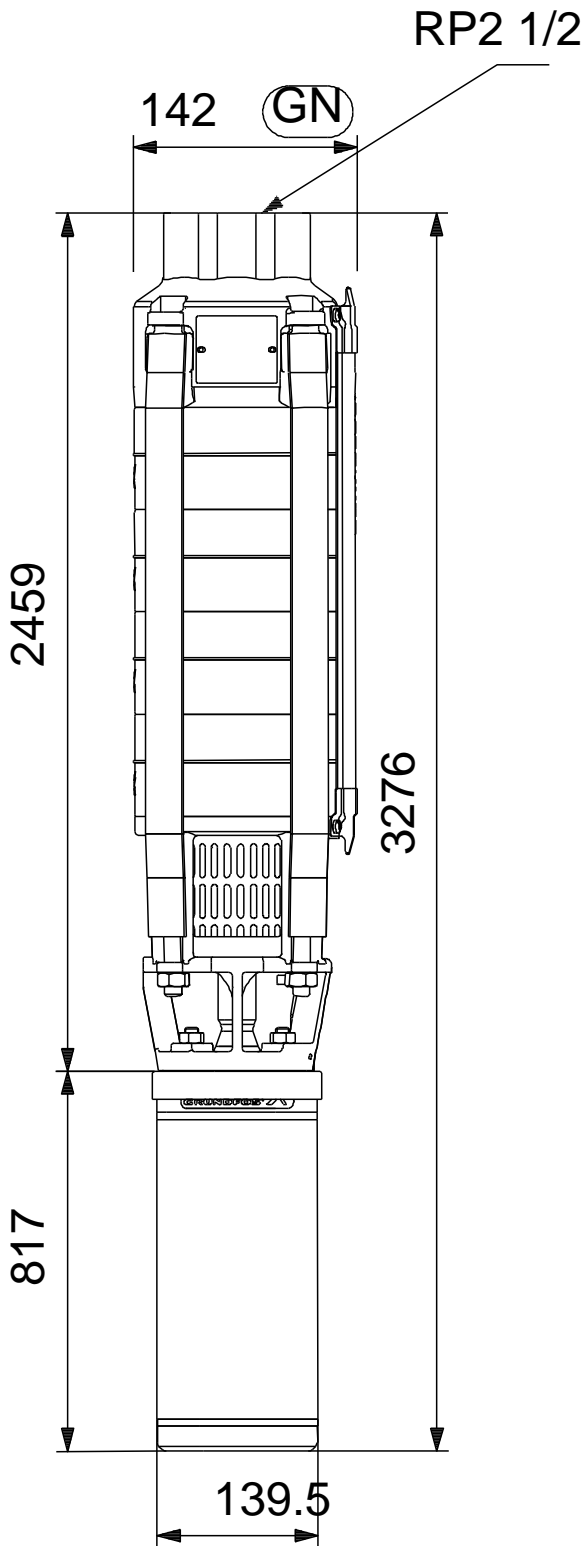

Note! All units are in [mm] unless others are stated.  
Disclaimer: This simplified dimensional drawing does not show all details.



## 12A01936 SP 17-36 50 Hz



U1, W2	Brown
V1, U2	Black
W1, V2	Grey

Note! All units are in [mm] unless others are stated.